



THUNDER GROUP[®]

www.thundergroup.com



Your
Value Added
One Stop
Supplier

NEW
Melamine
Dinnerware
pages 10-21

2024 Catalog



Scan the
QR code
to visit our
website.

Melamine Dinnerware • Asian Cookware • Asian Tableware • Buffetware
• Food Preparation • Gas & Electric • Janitorial • Kitchen Utensils • Professional Cookware • Table Top Services • Signage
• Shelving • Worktable • Melamine Dinnerware • Asian Cookware • Asian Tableware • Bakeware & Supplies • Bar Supplies
• Catering & Buffetware • Food Preparation • Gas & Electric • Janitorial • Kitchen Utensils • Professional Cookware • Table
Top Services • Signage • Shelving • Worktable • Melamine Dinnerware • Asian Cookware • Asian Tableware • Bakeware
& Supplies • Bar Supplies • Catering & Buffetware • Food Preparation • Gas & Electric • Janitorial • Kitchen Utensils • Professional
Cookware • Table Top Services • Signage • Shelving • Worktable • Melamine Dinnerware • Asian Cookware • Asian
Tableware • Bakeware & Supplies • Bar Supplies • Catering & Buffetware • Food Preparation • Gas & Electric • Janitorial
Kitchen Utensils • Professional Cookware • Table Top Services • Signage • Shelving • Worktable • Melamine Dinnerware
Asian Tableware • Bakeware & Supplies • Bar Supplies • Catering & Buffetware • Food Preparation • Gas & Electric
& Electric • Janitorial • Kitchen Utensils • Professional Cookware • Table Top Services • Signage • Shelving • Worktable
Melamine Dinnerware • Asian Cookware • Asian Tableware • Bakeware & Supplies • Bar Supplies • Catering & Buffetware
Food Preparation • Gas & Electric • Janitorial • Kitchen Utensils • Professional Cookware • Table Top Services • Signage



THUNDER GROUP[®]

www.thundergroup.com

NEW YORK BRANCH
33 Truman Drive South
Edison, NJ 08817
Tel: (732) 777-1977
Fax: (732) 777-0117
eFax: (626) 551-0388

CORPORATE - CALIFORNIA
780 South Nogales Street
City of Industry, CA 91748
Tel: (626) 935-1605
Fax: (626) 935-1609

TEXAS BRANCH
10702 Cash Road
Stafford, TX 77477
Tel: (713) 690-0111
Fax: (713) 690-0123
eFax: (626) 465-4692

ILLINOIS BRANCH
8402 #E West 183rd Street
Tinley Park, IL 60487
Tel: (855) 395-5560
Fax: (708) 429-7125

FLORIDA BRANCH
10599 NW 67th Street
Tamarac, FL 33321
Tel: (954) 724-5214
Fax: (954) 337-0222



Product Categories

Melamine
Dinnerware

8



Asian
Cookware

178



Asian
Tableware

190



Bakeware
& Supplies

198

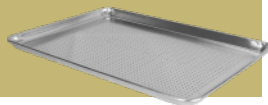

Bar
Supplies

212



Catering &
Buffetware

232



Food
Preparation

242



Gas &
Electric

270



Janitorial
Services

276



Kitchen
Utensils

286



Professional
Cookware

318



Table Top
Services

330



Signage
Accessories

368



Shelving
Units

372



Stainless Steel
Worktables

376



Index By
Item Number

381



Icon Legend on page 380

A	Airpot	342	C	Can, Trash	281
	Aluminum			Card Number, Plastic	332
	Sheet Pan Truck	201		Catcher, Cap	219
	Layer Cake Pan	204		Chafer	
B	Bag, Pizza	210		Continental	233
	Bagger, French Fry	291		Deluxe	232
	Baller, Melon, Deluxe	244		Economy	236
	Bar Caddy	222		Gold Accented	234
	Bar, Adaptor	245		Marmite	232
	Basin			Parts & Accessories	237
	Aluminum	178		Roll Top	232, 225
	Polar, Stainless Steel	311		Stackable	235
	Sushi Basin, Plastic	191		Check Cover	335
	Basket			Check Spindle	336
	Breeding	315		China Cap	312
	Donut Basket	264		Chopstick	
	Fry, Wire	329		Melamine	197
	Handwoven	348		Plastic	197
	Plastic	311, 349		Colander	
	Steamer, Aluminum	323		Aluminum	310
	Taco Bowl / Basket	291		Asian Style	179
	Tostada	291		Plastic	311
	Bell, Table	346		Stainless Steel	310
	Bento Box, Makinouchi Bento Server	191		Compartment, Stainless Steel	220
	Bins, Ingredient	259		Condiment, Stainless Steel	220
	Board			Condiment Jar & Accessories	332
	Cutting, Rectangular	260		Cone, Safety	280
	Color Coded	261		Container	
	Fajita Board	353		Food Storage	249 to 259
	Heavy Duty	260		Food Storage Lid	249 to 259
	Boards	260		Insulated Rice Container	195
	Ping Pong	260		Rice Container	195
	Round	260		Cookware	
	Booster Seat	367		7 Piece Set, Stainless Steel	321
	Bottle			Brazier, Aluminum	320
	Pourers	226 to 229		Double Boiler, Aluminum	327
	Squeeze, Plastic	344		Pasta, Aluminum	325
	Bowl			Saute Pan/Lid	324
	Cascading	24, 32, 58, 66		Stainless Steel	318 to 321
	Donburi With Handle	158		Stock Pot, Aluminum	322, 323
	Miso Soup, Melamine	158		Turkey Pot, Aluminum	327
	Miso Soup, Wood	190		Cool Handle	328
	Mixing	309		Cover	
	Nabemono Bowl, Cast Iron	192		Divided, Stainless Steel	243
	Rice, Wood	190		Plate	241
	Salsa	346		Sheet Pan	201
	Shabu Shabu Bowl, Cast Iron	192		Wok	184
	Soba	158		Cracker, Lobster	355
	Soba Noodle, Melamine	158		Creamer, Bell	339
	Woven Wood	347		Cruet, Oil & Vinegar	331
	Box			Crumber, Table	344
	Cutlery	284		Cup	
	Knock Box, Coffee	341		French Fry	337
	Pizza Dough	258		Malt	223
	Brush			Sauce	337
	Decanter	341		Cutter	
	Cutting Board	262		Cheese	263
	Pastry, Boar	269		Croissant Cutter	211
	Pastry, Nylon	269		French Fry	290
	Wire	317	D	Decanter	218
	Wok	317		Dipper	289
	Bucket, Wine Bucket, Stainless Steel	231		Disher	286 to 287
	Buffetware	239		Dishes	
	Burner			Au Gratin	338
	Duck Burner	188		Sherbet	338
	Jet Burner	188		Swirl, Dessert	349
	Bus Box	282		Dispenser	
	Bus Cart	283		Beverage	258
	Bus Cart Bin	283		Juice	238
	Bus Trays	284		Napkin	331
				Stirrer / Straw	331

Sugar / Cheese	331	Gravy Boat	336
Syrup	331	Griddle Set	344
Toothpicks	331	Grinder, Marble	178
Paper Towel Dispensers, Plastic	278	Gripper	
Soap Dispensers, Plastic	276	Pizza, Aluminum	210
Soap Dispensers, Stainless Steel	276	Pizza, Steel	210
Toilet Paper Dispenser, Plastic	277		
Toilet Paper Dispenser, Stainless Steel	277	H Hanger, Wire Glass	
Toilet Seat Cover Dispenser, Plastic/Chrome	278	Brass	225
Toilet Seat Cover Dispenser, Stainless Steel	278	Chrome	225
Display, Pastry	345	High Chair	367
Divider-Dough	211	Holder	
Double Roaster	325	Buffet Utensil	296
Dredger,		Check	336
Polycarbonate	205	Chopsticks, Plastic	197
Stainless Steel	205	Condiment Pack	241
Aluminum	205	Flatware Cylinder	241
Drinkware, Polycarbonate		Ham Holder	264
Beer Mug	213	Salt & Pepper	330
Belize Tumbler	350	Shoyu Holder, Shiraki Wood	193
Bucket, Ice	216	Sugar Pack	333
Carafes	218	Taco	347
Champagne Glass	217	Hood Filter	279
Classic Highball	215		
Classic Rock Glass	215	I Ice	
Cocktail Glass	216	Chipper	222
Diamond Tumbler	351	Pick	222
English Pub Glass	214		
Highball Glass	213	J Jigger, Stainless Steel	223
Hurricane Glass	217	Juicer	317
Margarita Glass	216		
Martini Glass	216	K Knife	
Napa Decanter	218	Angle	182
Pilsner Glass	213	Asian Cleaver	183
Pint Glass	214	Bread	353
Rock Glass	213	Chinese Cleaver	183
Schooner	218	Clam	355
Shot Glass	215	Cow	181
Tumbler	352	Carving	181
Wine Glass	217	Japanese	181
Dust Pan	279	King	182
		Ping	182
E Egg Cups	337	Sashimi	181
Egg Ring	302	Steak	353
		Wan Woo Style	183
F Filter, Coffee	340		
Flatware		L Ladle	
Atlantic	356	One Piece, Polycarbonate	298
Dakota	362	One Piece, Stainless Steel	294, 298
Diamond	357	Shovel With Wood Handle	178
Domillion	366	Two Piece, Stainless Steel	294
Elizabeth	358	Water Ladle	311
Esquire	363	Heat Lamp	
Jewel	364	Heat Lamp	275
Legend	364	Heat Lamp Bulbs	275
Salem	363	Lantern, Japanese	196
Simplicity	359	Liner, Bar	225
Sea Shell	365		
Sunflower	365	M Magnetic Bar	
Tahoe	362	Plastic	268
Wilshire	360	Wooden	268
Windsor	366	Masher, Potato	292
York	361	Mat	
Funnel		Interlocking Bar	224
Plastic	245	Bar Serving	224
Stainless Steel	245	Welcome Carpet	196
		Measuring	
G Glove		Cup, Polycarbonate	276
Latex	280	Liquid, Aluminum	205
Rubber	280	Spoon/Scoop	206
Grates, Wire, Chrome Plated	265	Spoon Set, Stainless Steel	206
Grater	244, 292	Spoon Set, Aluminum	206

Melamine	
Arcadia	34 to 36
Black Pearl	86 to 89
Blue Bamboo	139 to 146
Blue Dragon	104 to 109
Blue Jade	166 to 168
Classic Black	22 to 25
Classic Red	26 to 29
Classic White	30 to 33
Color Green	40 to 43
Color Ivory	44 to 47
Color Orange	48 to 51
Color Pure Red	52 to 55
Color Purple	56 to 59
Color White	60 to 63
Color Yellow	64 to 67
Gold Orchid	147 to 151
Gold Pearl	90 to 92
Gastronorm Pans	176 to 177
Graham	76 to 80
Imperial	110 to 114
Jazz	81 to 85
Longevity	115 to 120
Lotus	121 to 126
Nustone Tan	68 to 71
Nustone White	72 to 75
Passion Pearl	95 to 97
Passion Red	98 to 100
Passion White	101 to 103
Peacock	127 to 132
Rose	133 to 138
San Marino	37 to 39
Seaside	10 to 12
Serving Utensil	76 to 77
Stone Blue	28 to 30
Stone Grey	31 to 33
Tenmoku	152 to 156
Victoria	13 to 15
Wei	161 to 167
Menu Cover	334, 335
Mixing Paddle	
Stainless Steel	263
Wood	263
Mop	
Handle & Buckets	280
Holder	276
Muddler	221
N Noodle Machine	263
Nozzle, Burner	188
O Opener	
Bottle	219
Can	219
Punch Can	219
Rotary Can	219
Table Mount Wine Opener	219
Table Mount Can Opener	316
P Pads & Bristles, Scrubbing	285
Pail	247
Pan	
Bake Pan, Aluminum	199
False Bottom, Stainless Steel	246
Food Pan/Lid, Polycarbonate	252 to 255
Food Pan Drain Shelf, Poly	253, 255
Fry Pan, Aluminum	328
Inset	247
Layer Cake, Aluminum	204
Muffin, Aluminum	199
Muffin, Carbon Steel	199

Sauce Pan/Pot, Lid Aluminum	326
Sheet, Aluminum	200
Sheet, Stainless Steel	200
Snow Flat Pan	186
Spillage, Stainless Steel	246
Steam Pan	242, 243
Steam Pan Lid	243
Steam Pan, Perforated	243
Water Pans, Aluminum	246
Peel, Pizza	210
Peeler	292
Pie Marker	203
Pitcher	
Milk	339
Syrup	337
Water	214
Plate	
Adaptor, Stainless Steel	245
BBQ Plate - Cast Iron	186
Sushi Plate	193
Platter	
Fish, Melamine	196
Oval, Stainless Steel	240
Sizzling	354
Underliner, Bakelite	354
Plunger	280
Portion Controller	288
Pot	
Bain Marie	247
Insulated Sushi Rice	189
Tea	340

R Rack	
Cutting Board	262
Dunnage	284
Hand Roll, Plastic	191
Icing/Cooling Rack	265
Knife	268
Pizza	262
Steam, Round	264
Wok	184
Rail, Stainless	220
Ramekin	
ABS	337
Melamine	169 to 173
Plastic	172
Rice Cloth	266
Rice Cooker	
Electric	273
Gas	272
Ricer, Potato	305
Rimmer, Salt And Sugar Glass	222
Roller Docker	211
Rolling Pin	
Aluminum	211
Wood	211
Wood Rolling Pin Asian Style	178

S Scales	
Chinese Catts, Bowl Platform	266
Scales, Flat Platform	266
Scissors	115
Scoop	
Aluminum	293
Polycarbonate	293
Scrap Block	285
Scraper	
Plastic	308
Silicon	308
Stainless Steel	308
Screen	
Donut, Square	264

Fryer	265	Sushi Roller	197
Pizza Screen, Aluminum	209	Sushi Server, Shiraki Wood	193
Sealing Machine	271	Sweeper	
Server		Crumb	344
Coffee	343	Dust Pan	279
Pie	203		
Swirl Double Wall	343	T Tea Ball	340
Vacuum	341	Tenderizer, Meat	305
Shaker		Thermometer	
Cocktail, Stainless Steel	223	Dial with hook	267
Salt & Pepper, Glass	330	Dial Pocket	267
Shot, Plastic	218	Dial Deep Fry	267
Swirl Cheese, Glass	330	Dial Meat	267
Shelving		Liquid Deep Candy	268
Chrome Plated	372	Liquid Oven	268
Epoxy Coated	373	Liquid Scale Horizontal	268
Parts / Accessories	372, 373	Timer 60 mins	266
Sifter, Flour, Stainless	211	Toilet Seat Paper	216
Sign,		Tong	
Caution	280	Bar	221
Chain	341	Cake	303
Tent	340	Hamburger	303
Signage	368 to 371	Pastry	303
Information with Symbols		Pom	303
Information with Symbols and Braille		Polycarbonate	301
Skewer		Stainless Steel	302, 304
Bamboo	179	Toothpicks	193
Stainless Steel	307	Tray	
Skimmer		Compartment	346
Bamboo Handle, Galvanized	180	Drip Tray	340
Bamboo Handle, Stainless Steel	179	Fast Food	345
Noodle Skimmer	180	Fruit Tray, Polycarbonate	216
Small Skimmers, Shabu Shabu	180	Obon Serving	191
Slicer, Egg	263	Pastry	345
Snail		Pizza Tray, Coupe, Aluminum	209
Dish	355	Pizza Tray, Wide Rim, Aluminum	209
Fork	355	Round, Stainless Steel	240
Tong	355	Serving Fiberglass	231
Spade, Ice Cream	289	Serving Slip Resistant	230
Spatula	307	Tip	336
Spoon		Truck	
Bamboo Spoon	190	Sheet Pan, Aluminum	201
Bar, Deluxe	221	Turner	306
Basting	297		
Buffet	300	W Warmer	
Curved Basting	296	Butter	338
Grapefruit	355	Food	270
Luxor, Stainless Steel	238	Rice, Electric	273
Multi-Purpose	295	Soup, Electric	270, 271
Perforated	299, 300	Tortilla	347
Rice, Plastic	195	Whip	
Serving	299, 300	Dome	312
Vegetable	295	French	312
Wooden	178	Piano	312
Spreader	307	Tear Drop	312
Stand		Wok	
Cake	240	Chafing, Set	194
Pizza	337	Curved Rim	184
Tray	367	Japanese Jin-Ping	185
Wire	233	Non-Stick Wood Handle	185
Steak Weight	305	San Bai Wok	186
Steamer, Aluminum	187	Stainless Wok And Cover	184
Stove		Taiwan	185
Fast Stove	189	Wood	
Propane	275	Boat	192
Induction	271	Bridge	192
Strainer		Work Table	376, 377
Bar	221		
Floor	283		
Julep	221		
Mesh	312, 313		
Sink	285		

MELAMINE DINNERWARE

Melamine is a non-toxic material, which can be designed accordingly for a variety of Foodservice uses - Healthcare, Cruise Lines, Educational & Correctional Institutions, Buffets, Restaurants and Casinos.



This durable, break-resistant, non-toxic dinnerware can withstand temperatures from 32°F to 212°F (0°C to 100°C).

It is not recommended for microwave use, but is dishwasher safe. (Recommended for low temperature setting & top rack load only)

Our Melamine Dinnerware lines include a wide variety of shapes, sizes, colors, and designs - geared towards meeting the diverse needs and styles of our customers. All of our melamine products meet NSF (National Sanitary Foundation) standards and are safe to use by all commercial Food Service operations. In addition, since Thunder Group manufactures these products, we also have the capability for private label or proprietary products to fit your customer's needs.



Collection Index

Melamine

Seaside	10
Victoria	13
Classic Black	22
Classic Red	26
Classic White	30
Stone Blue	16
Stone Grey	19
Arcadia	34
San Marino	37
Color Green	40
Color Ivory	44
Color Orange	48
Color Pure Red	52
Color Purple	56
Color White	60
Color Yellow	64
Nustone Tan	68
Nustone White	72
Graham	76
Jazz	81
Black Pearl	86
Gold Pearl	90
Serving Boards	93
Passion Pearl	95
Passion Red	98
Passion White	101
Blue Dragon	104
Imperial	110
Longevity	115
Lotus	121
Peacock	127
Rose	133
Blue Bamboo	139
Gold Orchid	147
Tenmoku	152
Two Tone	157
Wei	159
Blue Jade	166
Ramekin	169
Serving Utencils	174
Gastronorm Pans	166

NEW

Seaside



Round Plate • Sauce Dish •
Wavy Tray • Soup Bowl •
Lotus Shaped Plate





Item	Description	U/M	Weight Gross lbs	Inner Pack	Master Pack	Cu. Ft.
5705SS	11 oz, 4¾" Diameter x 2⅜" Height, Rice Bowl	Dozen	19.40	1.0	5.0	0.89
5706SS	16 oz, 6" Diameter x 2¾" Height, Soup Bowl	Dozen	29.17	0.5	4.0	1.38
5707SS	30 oz, 7½" Diameter x 3¼" Height, Soup Bowl	Dozen	26.19	0.5	2.0	1.34
5770SS	24 oz, 6¾" Diameter x 2⅝" Height, Soup Bowl	Dozen	28.04	0.5	4.0	1.72
5780SS	32 oz, 7½" Diameter x 3⅝" Height, Soup Bowl	Dozen	34.33	0.5	3.0	2.09

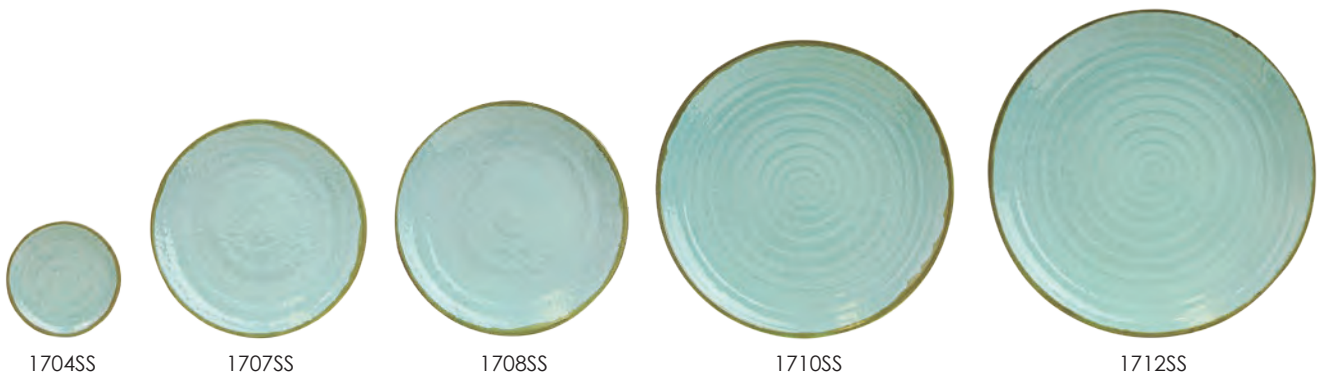

Item	Description	U/M	Weight Gross lbs	Inner Pack	Master Pack	Cu. Ft.
1704SS	4" Diameter x ½" Height, Round Plate	Dozen	18.12	1.0	8.0	0.46
1707SS	7½" Diameter x 1⅝" Height, Round Plate	Dozen	35.91	0.5	4.0	1.47
1708SS	8¼" Diameter x 1¼" Height, Round Plate	Dozen	23.94	0.5	2.0	0.93
1710SS	10½" Diameter x 1⅜" Height, Round Plate	Dozen	33.31	0.5	2.0	1.43
1712SS	11¾" Diameter x 1½" Height, Round Plate	Dozen	39.44	0.5	2.0	1.77



Item	Description	U/M	Weight Gross lbs	Inner Pack	Master Pack	Cu. Ft.
2404SS	3 oz, 4" x 3¾" x 1⅝", Wavy Rectangular Sauce Dish	DOZEN	34.24	1.0	12.0	0.90
2406SS	8 oz, 6¼" x 4¾" x 1⅝", Wavy Rectangular Plate	DOZEN	33.33	1.0	6.0	0.89
2408SS	12 oz, 8½" x 5¾" x 1⅝", Wavy Rectangular Plate	DOZEN	35.23	1.0	4.0	0.93

Seaside

MELAMINE



1806SS



1807SS



1808SS



1809SS



1810SS



1812SS



1814SS



1816SS

Item	Description	U/M	Weight Gross lbs	Inner Pack	Master Pack	Cu. Ft.
1806SS	6" Diameter x 1" Height, Lotus Shape Plate	Dozen	31.79	1.0	6.0	0.96
1807SS	7¼" Diameter x 1¼" Height, Lotus Shape Plate	Dozen	34.96	0.5	4.0	1.39
1808SS	8¼" Diameter x 1¾" Height, Lotus Shape Plate	Dozen	24.52	0.5	2.0	0.95
1809SS	9¾" Diameter x 1¾" Height, Lotus Shape Plate	Dozen	27.95	0.5	2.0	1.10
1810SS	10½" Diameter x 1½" Height, Lotus Shape Plate	Dozen	35.19	0.5	2.0	1.55
1812SS	12" Diameter x 1¾" Height, Lotus Shape Plate	Dozen	36.42	0.5	2.0	1.81
1814SS	14" Diameter x 1¾" Height, Lotus Shape Plate	Dozen	25.04	0.3	1.0	1.79
1816SS	16" Diameter x 1¾" Height, Lotus Shape Plate	Dozen	37.06	0.3	1.0	2.39

NEW
Victoria



Round Plate • Wavy Tray • Soup
Bowl • Lotus Shaped Plate



Victoria



Item	Description	U/M	Weight Gross lbs	Inner Pack	Master Pack	Cu. Ft.
5705VT	11 oz, 4¾" Diameter x 2¾" Height, Rice Bowl	Dozen	19.40	1.0	5.0	0.89
5706VT	16 oz, 6" Diameter x 2¾" Height, Soup Bowl	Dozen	29.17	0.5	4.0	1.38
5707VT	30 oz, 7½" Diameter x 3¼" Height, Soup Bowl	Dozen	26.19	0.5	2.0	1.34
5770VT	24 oz, 6¾" Diameter x 2½" Height, Soup Bowl	Dozen	28.04	0.5	4.0	1.72
5780VT	32 oz, 7½" Diameter x 3¾" Height, Soup Bowl	Dozen	34.33	0.5	3.0	2.09



Item	Description	U/M	Weight Gross lbs	Inner Pack	Master Pack	Cu. Ft.
1704VT	4" Diameter x ½" Height, Round Plate	Dozen	18.12	1.0	8.0	0.46
1707VT	7½" Diameter x 1⅛" Height, Round Plate	Dozen	35.91	0.5	4.0	1.47
1708VT	8¼" Diameter x 1¼" Height, Round Plate	Dozen	23.94	0.5	2.0	0.93
1710VT	10½" Diameter x 1⅜" Height, Round Plate	Dozen	33.31	0.5	2.0	1.43
1712VT	11¾" Diameter x 1½" Height, Round Plate	Dozen	39.44	0.5	2.0	1.77



Item	Description	U/M	Weight Gross lbs	Inner Pack	Master Pack	Cu. Ft.
2404VT	3 oz, 4" x 3¾" x 1⅛", Wavy Rectangular Sauce Dish	Dozen	34.24	1.0	12.0	0.90
2406VT	8 oz, 6¼" x 4¾" x 1⅛", Wavy Rectangular Plate	Dozen	33.33	1.0	6.0	0.89
2408VT	12 oz, 8½" x 5¾" x 1⅛", Wavy Rectangular Plate	Dozen	35.23	1.0	4.0	0.93





1806VT



1807VT



1808VT



1809VT



1810VT



1812VT



1814VT



1816VT

Item	Description	U/M	Weight Gross lbs	Inner Pack	Master Pack	Cu. Ft.
1806VT	6" Diameter x 1" Height, Lotus Shape Plate	Dozen	31.79	1.0	6.0	0.96
1807VT	7¼" Diameter x 1¼" Height, Lotus Shape Plate	Dozen	34.96	0.5	4.0	1.39
1808VT	8½" Diameter x 1⅝" Height, Lotus Shape Plate	Dozen	24.52	0.5	2.0	0.95
1809VT	9¾" Diameter x 1¾" Height, Lotus Shape Plate	Dozen	27.95	0.5	2.0	1.10
1810VT	10½" Diameter x 1½" Height, Lotus Shape Plate	Dozen	35.19	0.5	2.0	1.55
1812VT	12" Diameter x 1⅝" Height, Lotus Shape Plate	Dozen	36.42	0.5	2.0	1.81
1814VT	14" Diameter x 1¾" Height, Lotus Shape Plate	Dozen	25.04	0.3	1.0	1.79
1816VT	16" Diameter x 1⅞" Height, Lotus Shape Plate	Dozen	37.06	0.3	1.0	2.39

NEW

Stone Blue

MELAMINE



Wavy Soup Bowl • Rectangle
Tray • Square Salad Bowl •
Deep Square Bowl





29004SB



29006SB



29007SB

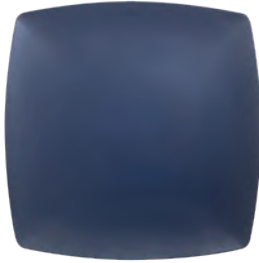

29009SB



29010SB



29012SB

Item	Description	U/M	Weight Gross lbs	Inner Pack	Master Pack	Cu. Ft.
29004SB	4½" x 4½", ½" Deep, Square Plate	Dozen	7.96	1.0	4.0	0.24
29006SB	6" x 6", ½" Deep, Square Plate	Dozen	16.42	1.0	4.0	0.55
29007SB	7¼" x 7¼", ½" Deep, Square Plate	Dozen	13.80	1.0	2.0	0.45
29009SB	9" x 9", 1" Deep, Square Plate	Dozen	33.10	1.0	2.0	0.99
29010SB	10" x 10", 1" Deep, Square Plate	Dozen	44.07	1.0	2.0	1.24
29012SB	12" x 12", 1" Deep, Square Plate	Dozen	35.98	1.0	1.0	0.90



47128SB



49095SB



49136SB



49168SB



49208SB

Item	Description	U/M	Weight Gross lbs	Inner Pack	Master Pack	Cu. Ft.
47128SB	12½" x 8", 1½" Deep, Rectangle Tray	Dozen	41.15	1.0	2.0	0.93
49095SB	9½" x 5¼", ¾" Deep, Rectangle Tray	Dozen	28.02	1.0	4.0	0.69
49136SB	13" x 6½", 1" Deep, Rectangle Tray	Dozen	38.32	1.0	3.0	1.01
49168SB	16½" x 8", 1½" Deep, Rectangle Tray	Dozen	44.00	1.0	2.0	1.19
49208SB	20" x 8", 1¾" Deep, Rectangle Tray	Dozen	35.49	1.0	1.0	0.65

Stone Blue



24006SB



24007SB



24010SB



24012SB

Item	Description	U/M	Weight Gross lbs	Inner Pack	Master Pack	Cu. Ft.
24006SB	6" x 6", 1" Deep, Flare Plate	Dozen	16.42	1.0	4.0	0.67
24007SB	7 $\frac{3}{8}$ " x 7 $\frac{3}{8}$ ", 1 $\frac{3}{8}$ " Deep, Flare Plate	Dozen	17.24	1.0	2.0	0.57
24010SB	10" x 10", 1 $\frac{3}{4}$ " Deep, Flare Plate	Dozen	38.87	1.0	2.0	1.23
24012SB	12 $\frac{3}{8}$ " x 12 $\frac{3}{8}$ ", 2" Deep, Flare Plate	Dozen	33.09	1.0	1.0	1.02



39093SB



62008SB



63010SB



19001SB



19002SB

Item	Description	U/M	Weight Gross lbs	Inner Pack	Master Pack	Cu. Ft.
39093SB	45 oz, 9" Diameter x 3" Deep, Wavy Soup Bowl	Dozen	55.89	1.0	4.0	2.33
62008SB	28 oz, 8 $\frac{1}{2}$ " x 8 $\frac{1}{2}$ ", 1 $\frac{1}{8}$ " Deep, Square Salad Bowl	Dozen	30.20	1.0	2.0	0.82
63010SB	22 oz, 10 $\frac{1}{2}$ " x 1 $\frac{1}{8}$ " Deep, Pasta Bowl	Dozen	37.08	1.0	2.0	1.18
19001SB	2 oz, 3 $\frac{3}{4}$ " x 2 $\frac{1}{2}$ ", Sauce Dish	Dozen	17.97	1.0	12.0	0.64
19002SB	4 oz, 6" x 3", Twin Sauce Dish	Dozen	29.61	1.0	12.0	1.27



69003SB



69004SB



69005SB



69007SB



69008SB



69009SB

Item	Description	U/M	Weight Gross lbs	Inner Pack	Master Pack	Cu. Ft.
69003SB	2 $\frac{1}{2}$ oz, 2 $\frac{5}{8}$ " x 2 $\frac{5}{8}$ ", 1 $\frac{3}{8}$ " Deep, Square Bowl	Dozen	13.21	1.0	8.0	0.94
69004SB	8 oz, 3 $\frac{7}{8}$ " x 3 $\frac{7}{8}$ ", 1 $\frac{3}{4}$ " Deep, Square Bowl	Dozen	24.22	1.0	8.0	0.64
69005SB	22 oz, 5 $\frac{1}{2}$ " x 5 $\frac{1}{2}$ ", 2 $\frac{1}{4}$ " Deep, Square Bowl	Dozen	35.22	1.0	6.0	1.10
69007SB	40 oz, 7 $\frac{1}{8}$ " x 7 $\frac{1}{8}$ ", 2 $\frac{3}{4}$ " Deep, Square Bowl	Dozen	53.85	1.0	4.0	1.56
69008SB	60 oz, 8" x 8", 3 $\frac{1}{4}$ " Deep, Square Bowl	Dozen	34.01	1.0	2.0	1.10
69009SB	90 oz, 9" x 9", 3 $\frac{3}{8}$ " Deep, Square Bowl	Dozen	48.25	1.0	2.0	1.02



NEW
Stone Grey



Square Plates • Pasta Bowl •
Rectangle Tray • Deep Square
Bowl • Deep Flare Plate



Stone Grey

MELAMINE

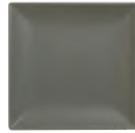

29004SG



29006SG



29007SG

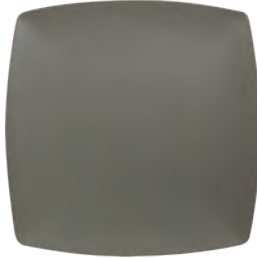

29009SG

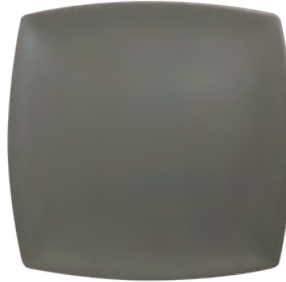

29010SG



29012SG

Item	Description	U/M	Weight Gross lbs	Inner Pack	Master Pack	Cu. Ft.
29004SG	4½" x 4½", ½" Deep, Square Plate	Dozen	7.96	1.0	4.0	0.24
29006SG	6" x 6", ½" Deep, Square Plate	Dozen	16.42	1.0	4.0	0.55
29007SG	7¼" x 7¼", ½" Deep, Square Plate	Dozen	13.80	1.0	2.0	0.45
29009SG	9" x 9", 1" Deep, Square Plate	Dozen	33.10	1.0	2.0	0.99
29010SG	10" x 10", 1" Deep, Square Plate	Dozen	44.07	1.0	2.0	1.24
29012SG	12" x 12", 1" Deep, Square Plate	Dozen	35.98	1.0	1.0	0.90



47128SG



49095SG



49136SG



49168SG



49208SG

Item	Description	U/M	Weight Gross lbs	Inner Pack	Master Pack	Cu. Ft.
47128SG	12½" x 8", 1½" Deep, Rectangle Tray	Dozen	41.15	1.0	2.0	0.93
49095SG	9½" x 5¼", ¾" Deep, Rectangle Tray	Dozen	28.02	1.0	4.0	0.69
49136SG	13" x 6½", 1" Deep, Rectangle Tray	Dozen	38.32	1.0	3.0	1.01
49168SG	16½" x 8", 1½" Deep, Rectangle Tray	Dozen	44.00	1.0	2.0	1.19
49208SG	20" x 8", 1¾" Deep, Rectangle Tray	Dozen	35.49	1.0	1.0	0.65





24006SG



24007SG



24010SG



24012SG

Item	Description	U/M	Weight Gross lbs	Inner Pack	Master Pack	Cu. Ft.
24006SG	6" x 6", 1" Deep, Flare Plate	Dozen	16.42	1.0	4.0	0.67
24007SG	7 ³ / ₈ " x 7 ³ / ₈ ", 1 ³ / ₈ " Deep, Flare Plate	Dozen	17.24	1.0	2.0	0.57
24010SG	10" x 10", 1 ³ / ₄ " Deep, Flare Plate	Dozen	38.87	1.0	2.0	1.23
24012SG	12 ³ / ₈ " x 12 ³ / ₈ ", 2" Deep, Flare Plate	Dozen	33.09	1.0	1.0	1.02



39093SG



62008SG



63010SG



19001SG



19002SG

Item	Description	U/M	Weight Gross lbs	Inner Pack	Master Pack	Cu. Ft.
39093SG	45 oz, 9" Diameter x 3" Deep, Wavy Soup Bowl	Dozen	55.89	1.0	4.0	2.33
62008SG	28 oz, 8 ¹ / ₂ " x 8 ¹ / ₂ ", 1 ⁵ / ₈ " Deep, Square Salad Bowl	Dozen	30.20	1.0	2.0	0.82
63010SG	22 oz, 10 ¹ / ₂ " x 1 ³ / ₈ " Deep, Pasta Bowl	Dozen	37.08	1.0	2.0	1.18
19001SG	2 oz, 3 ³ / ₄ " x 2 ¹ / ₂ ", Sauce Dish	Dozen	17.97	1.0	12.0	0.64
19002SG	4 oz, 6" x 3", Twin Sauce Dish	Dozen	29.61	1.0	12.0	1.27



69003SG



69004SG



69005SG



69007SG



69008SG



69009SG

Item	Description	U/M	Weight Gross lbs	Inner Pack	Master Pack	Cu. Ft.
69003SG	2 ¹ / ₂ oz, 2 ⁵ / ₈ " x 2 ⁵ / ₈ ", 1 ³ / ₈ " Deep, Square Bowl	Dozen	13.21	1.0	8.0	0.94
69004SG	8 oz, 3 ³ / ₈ " x 3 ³ / ₈ ", 1 ³ / ₄ " Deep, Square Bowl	Dozen	24.22	1.0	8.0	0.64
69005SG	22 oz, 5 ¹ / ₂ " x 5 ¹ / ₂ ", 2 ¹ / ₄ " Deep, Square Bowl	Dozen	35.22	1.0	6.0	1.10
69007SG	40 oz, 7 ¹ / ₈ " x 7 ¹ / ₈ ", 2 ³ / ₄ " Deep, Square Bowl	Dozen	53.85	1.0	4.0	1.56
69008SG	60 oz, 8" x 8", 3 ¹ / ₄ " Deep, Square Bowl	Dozen	34.01	1.0	2.0	1.10
69009SG	90 oz, 9" x 9", 3 ⁵ / ₈ " Deep, Square Bowl	Dozen	48.25	1.0	2.0	1.02

Classic Black

MELAMINE



Square Plates • Cascade Bowl
Square Salad Bowl • Square
Bowl • Twin Sauce Dish





Item	Description	U/M	Weight Gross lbs	Inner Pack	Master Pack	Cu. Ft.
29004BK	4½" x 4½" x ½", Square Plate	Dozen	7.96	1	4	0.24
29006BK	6" x 6" x ½", Square Plate	Dozen	16.42	1	4	0.55
29007BK	7¼" x 7¼" x ½", Square Plate	Dozen	13.80	1	2	0.45
29009BK	9" x 9" x 1", Square Plate	Dozen	33.10	1	2	0.99
29010BK	10" x 10" x 1", Square Plate	Dozen	44.07	1	2	1.24
29012BK	12" x 12" x 1", Square Plate	Dozen	35.98	1	1	0.90

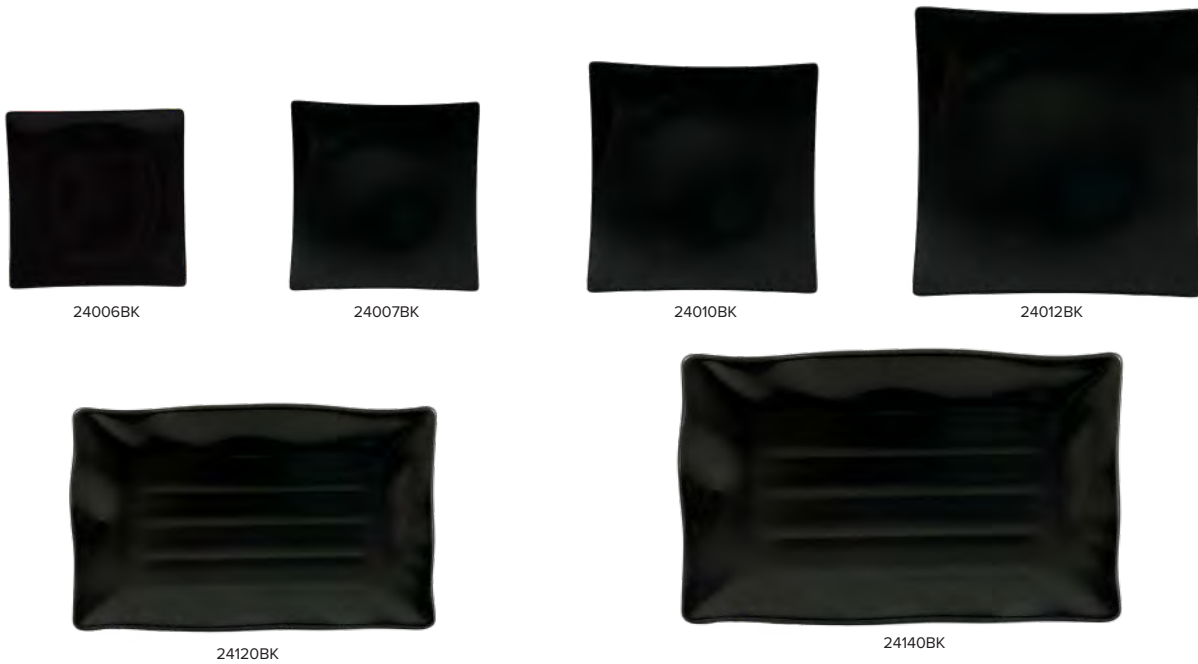

Item	Description	U/M	Weight Gross lbs	Inner Pack	Master Pack	Cu. Ft.
24006BK	6" x 6" x 1", Flare Plate	Dozen	16.42	1	4	0.67
24007BK	7¾" x 7¾" x 1¾", Flare Plate	Dozen	17.24	1	2	0.57
24010BK	10" x 10" x 1¾", Flare Plate	Dozen	38.87	1	2	1.23
24012BK	12¾" x 12¾" x 2", Flare Plate	Dozen	33.09	1	1	1.02
24120BK	11¼" x 7¼" x 1", Wavy Rectangular Plate	Dozen	25.77	1	3	1.41
24140BK	13½" x 9¾" x 1¾", Wavy Rectangular Plate	Dozen	39.20	1	3	2.20

Classic Black



39093BK



69003BK



69004BK



69005BK



69007BK



69008BK



69009BK

Item	Description	U/M	Weight Gross lbs	Inner Pack	Master Pack	Cu. Ft.
39093BK	45 oz, 9" Diameter x 3" Deep, Wavy Soup Bowl	Dozen	55.89	1	4	2.33
69003BK	2½ oz, 2⅝" x 2⅝" x 1⅜", Square Bowl	Dozen	13.21	1	8	0.94
69004BK	8 oz, 3⅞" x 3⅞" x 1¾", Square Bowl	Dozen	24.22	1	8	0.64
69005BK	22 oz, 5½" x 5½" x 2¼", Square Bowl	Dozen	35.22	1	6	1.10
69007BK	40 oz, 7⅞" x 7⅞" x 2¾", Square Bowl	Dozen	53.85	1	4	1.56
69008BK	60 oz, 8" x 8" x 3¼", Square Bowl	Dozen	34.01	1	2	1.10
69009BK	90 oz, 9" x 9" x 3⅝", Square Bowl	Dozen	48.25	1	2	1.02



CR804BK



CR805BK



CR806BK



CR807BK



39045BK



39050BK



39055BK

Item	Description	U/M	Weight Gross lbs	Inner Pack	Master Pack	Cu. Ft.
CR804BK	12 oz, 6½" Diameter x 1⅞" Low Side Height (3¼" High Side Height), Cascade Bowl	Dozen	42.95	1	6	1.78
CR805BK	16 oz, 8⅞" Diameter x 2¼" Low Side Height (4⅞" High Side Height), Cascade Bowl	Dozen	23.81	1	2	1.02
CR806BK	24 oz, 9¼" Diameter x 2¾" Low Side Height (5" High Side Height), Cascade Bowl	Dozen	31.88	1	2	1.52
CR807BK	35 oz, 10¼" Diameter x 2⅞" Low Side Height (5½" High Side Height), Cascade Bowl	Dozen	37.31	1	2	1.92
39045BK	11 oz, 4½" Diameter x 2¼" Height, Bowl	Dozen	19.75	1	4	1.04
39050BK	16 oz, 5⅞" Diameter x 2⅝" Height, Bowl	Dozen	20.11	1	4	1.08
39055BK	19 oz, 5⅝" Diameter x 2½" Height, Bowl	Dozen	30.31	1	4	1.50



Classic Black

2024



47128BK



49095BK



49136BK



49168BK



49208BK



19035BK



19045BK



19055BK

Item	Description	U/M	Weight Gross lbs	Inner Pack	Master Pack	Cu. Ft.
47128BK	12½" x 8" x 1⅛", Rectangle Tray	Dozen	41.15	1	2	0.93
49095BK	9½" x 5¼" x ¾", Rectangle Tray	Dozen	28.02	1	4	0.69
49136BK	13" x 6½" x 1", Rectangle Tray	Dozen	38.32	1	3	1.01
49168BK	16⅞" x 8" x 1⅛", Rectangle Tray	Dozen	44.00	1	2	1.19
49208BK	20" x 8" x 1⅜", Rectangle Tray	Dozen	35.49	1	1	0.65
19035BK	2 oz, 3½" Diameter x ¾" Deep, Round Saucer	Dozen	18.52	1	12	0.65
19045BK	4 oz, 4½" Diameter x 1" Deep, Round Saucer	Dozen	16.95	1	6	0.68
19055BK	8 oz, 5½" Diameter x 1¼" Deep, Round Saucer	Dozen	24.40	1	6	0.97



29110BK



29115BK



24110BK



19001BK



19002BK



7200BK



62008BK



63010BK

Item	Description	U/M	Weight Gross lbs	Inner Pack	Master Pack	Cu. Ft.
29110BK	10¼" x 4" x 1", Rectangular Appetizer Tray	Dozen	19.97	1	2	0.61
29115BK	15" x 5¼" x 1", Rectangular Appetizer Tray	Dozen	52.98	1	3	1.55
24110BK	11¼" x 5" x 1", Rectangular Plate	Dozen	33.84	1	3	1.01
19001BK	2 oz, 3¾" x 2½", Sauce Dish	Dozen	17.97	1	12	0.64
19002BK	4 oz, 6" x 3", Twin Sauce Dish	Dozen	29.61	1	12	1.27
7200BK	0.6 oz, 6⅜" x 1¾", Soup Spoon	Dozen	37.93	5	60	1.74
62008BK	28 oz, 8½" x 8½" x 1⅝", Square Salad Bowl	Dozen	30.20	1	2	0.82
63010BK	22 oz, 10½" x 10½" x 1⅜", Pasta Bowl	Dozen	37.08	1	2	1.18

****Soup Spoon is not NSF Certified.****

MELAMINE

Classic Red

MELAMINE



Square Plates • Soup Spoon •
Bowl • Pasta Bowl • Soup Bowl





Item	Description	U/M	Weight Gross lbs	Inner Pack	Master Pack	Cu. Ft.
29004PR	4½" x 4½" x ½", Square Plate	Dozen	7.96	1	4	0.24
29006PR	6" x 6" x ½", Square Plate	Dozen	16.42	1	4	0.55
29007PR	7¼" x 7¼" x ½", Square Plate	Dozen	13.80	1	2	0.45
29009PR	9" x 9" x 1", Square Plate	Dozen	33.10	1	2	0.99
29010PR	10" x 10" x 1", Square Plate	Dozen	44.07	1	2	1.24
29012PR	12" x 12" x 1", Square Plate	Dozen	35.98	1	1	0.90

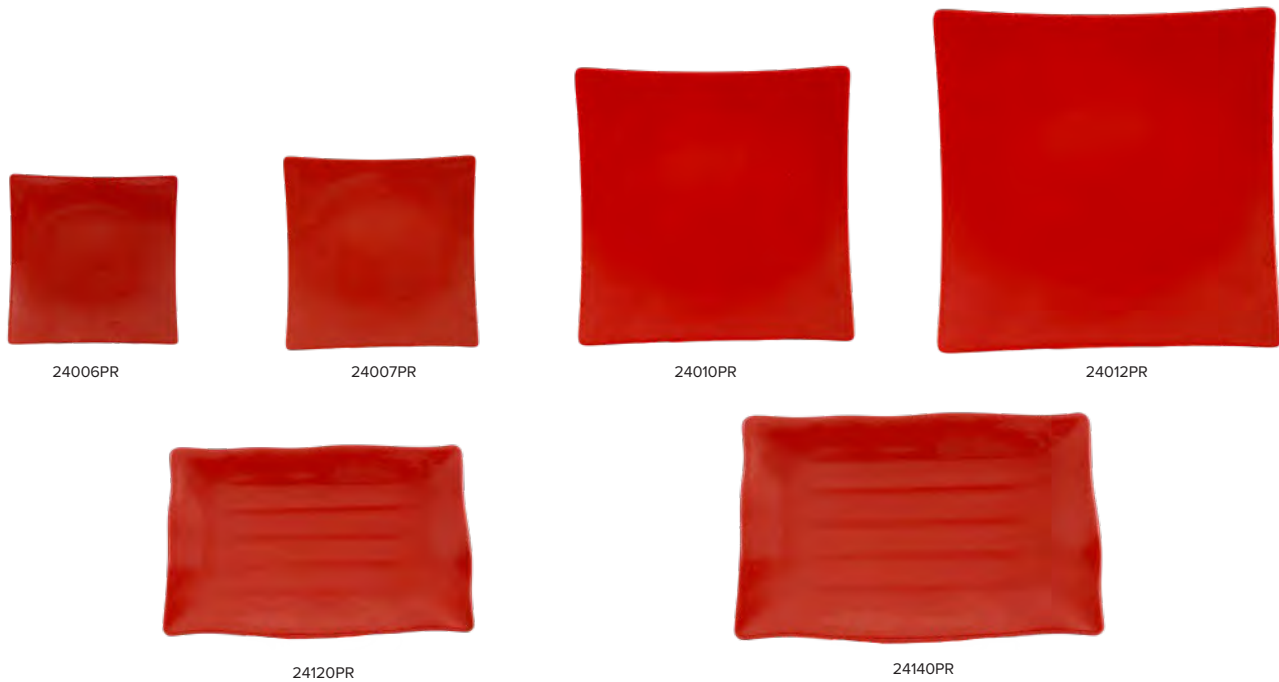

Item	Description	U/M	Weight Gross lbs	Inner Pack	Master Pack	Cu. Ft.
24006PR	6" x 6" x 1", Flare Plate	Dozen	16.42	1	4	0.67
24007PR	7¾" x 7¾" x 1⅜", Flare Plate	Dozen	17.24	1	2	0.57
24010PR	10" x 10" x 1¾", Flare Plate	Dozen	38.87	1	2	1.23
24012PR	12¾" x 12¾" x 2", Flare Plate	Dozen	33.09	1	1	1.02
24120PR	11¼" x 7¼" x 1", Wavy Rectangular Plate	Dozen	25.77	1	3	1.41
24140PR	13½" x 9⅝" x 1⅜", Wavy Rectangular Plate	Dozen	39.20	1	3	2.20

Classic Red

MELAMINE



47128PR



49095PR



49136PR



49168PR



49208PR

Item	Description	U/M	Weight Gross lbs	Inner Pack	Master Pack	Cu. Ft.
47128PR	12½" x 8" x 1⅛", Rectangle Tray	Dozen	41.15	1	2	0.93
49095PR	9½" x 5 ¼" x ¾", Rectangle Tray	Dozen	28.02	1	4	0.69
49136PR	13" x 6½" x 1", Rectangle Tray	Dozen	38.32	1	3	1.01
49168PR	16⅞" x 8" x 1⅛", Rectangle Tray	Dozen	44.00	1	2	1.19
49208PR	20" x 8" x 1⅜", Rectangle Tray	Dozen	35.49	1	1	0.65



29110PR



29115PR



24110PR

Item	Description	U/M	Weight Gross lbs	Inner Pack	Master Pack	Cu. Ft.
29110PR	10¼" x 4" x 1", Rectangular Appetizer Tray	Dozen	19.97	1	2	0.61
29115PR	15" x 5¼" x 1", Rectangular Appetizer Tray	Dozen	52.98	1	3	1.55
24110PR	11¼" x 5" x 1", Rectangular Plate	Dozen	33.84	1	3	1.01



69003PR



69004PR



69005PR



69007PR



69008PR



69009PR

Item	Description	U/M	Weight Gross lbs	Inner Pack	Master Pack	Cu. Ft.
69003PR	2½ oz, 2⅝" x 2⅝" x 1 ⅞", Square Bowl	Dozen	13.21	1	8	0.94
69004PR	8 oz, 3⅞" x 3⅞" x 1¾", Square Bowl	Dozen	24.22	1	8	0.64
69005PR	22 oz, 5½" x 5½" x 2¼", Square Bowl	Dozen	35.22	1	6	1.10
69007PR	40 oz, 7⅞" x 7⅞" x 2 ¾", Square Bowl	Dozen	53.85	1	4	1.56
69008PR	60 oz, 8" x 8" x 3¼", Square Bowl	Dozen	34.01	1	2	1.10
69009PR	90 oz, 9" x 9" x 3⅝", Square Bowl	Dozen	48.25	1	2	1.02



62008PR



63010PR



39093PR



39045PR



39050PR



39055PR



7200PR

Item	Description	U/M	Weight Gross lbs	Inner Pack	Master Pack	Cu. Ft.
62008PR	28 oz, 8½" x 8½" x 1⅝", Square Salad Bowl	Dozen	30.20	1	2	0.82
63010PR	22 oz, 10½" x 10½" x 1⅜", Pasta Bowl	Dozen	37.08	1	2	1.18
39093PR	45 oz, 9" Diameter x 3" Deep, Wavy Soup Bowl	Dozen	55.89	1	4	2.33
39045PR	11 oz, 4½" Diameter x 2¼" Height, Bowl	Dozen	19.75	1	4	1.04
39050PR	16 oz, 5⅞" Diameter x 2⅝" Height, Bowl	Dozen	20.11	1	4	1.08
39055PR	19 oz, 5⅝" Diameter x 2½" Height, Bowl	Dozen	30.31	1	4	1.50
7200PR	0.6 oz, 6⅜" x 1¾", Soup Spoon	Dozen	37.93	5	60	1.74

****Soup Spoon is not NSF Certified.****

Classic White

MELAMINE



Pasta Bowl • Soup Spoon •
Cascading Bowl • Square Bowls
• Square Plates





Item	Description	U/M	Weight Gross lbs	Inner Pack	Master Pack	Cu. Ft.
29004WT	4½" x 4½" x ½", Square Plate	Dozen	7.96	1	4	0.24
29006WT	6" x 6" x ½", Square Plate	Dozen	16.42	1	4	0.55
29007WT	7¼" x 7¼" x ½", Square Plate	Dozen	13.80	1	2	0.45
29009WT	9" x 9" x 1", Square Plate	Dozen	33.10	1	2	0.99
29010WT	10" x 10" x 1", Square Plate	Dozen	44.07	1	2	1.24
29012WT	12" x 12" x 1", Square Plate	Dozen	35.98	1	1	0.90

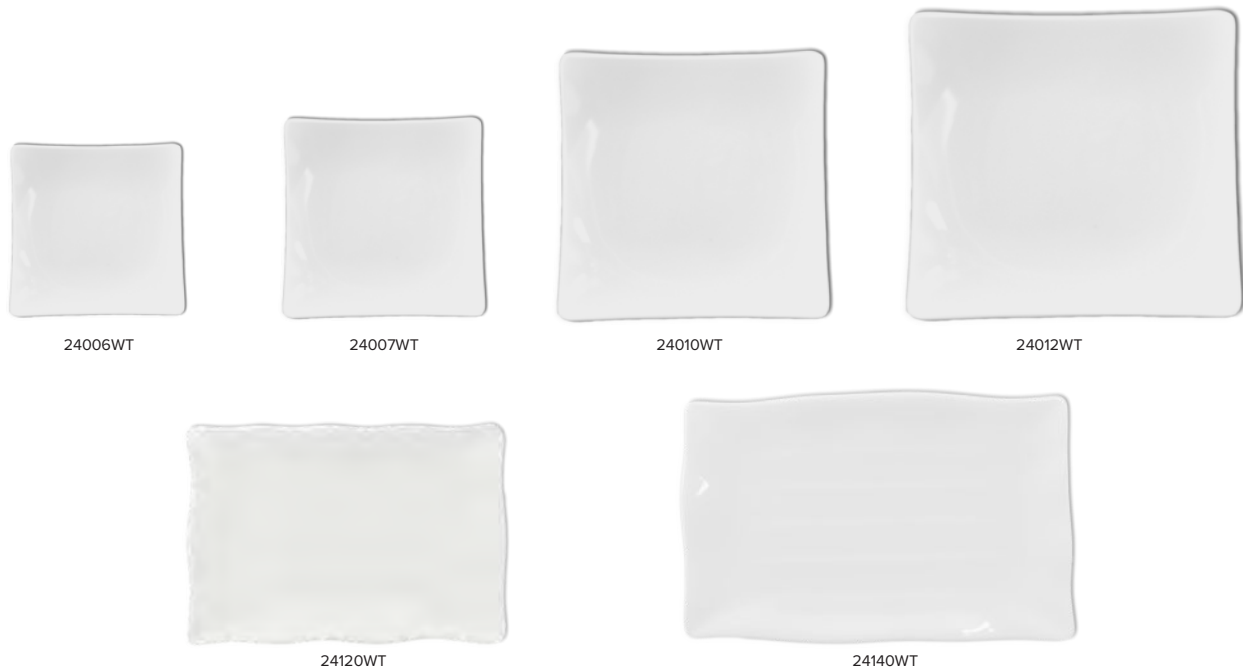

Item	Description	U/M	Weight Gross lbs	Inner Pack	Master Pack	Cu. Ft.
24006WT	6" x 6" x 1", Flare Plate	Dozen	16.42	1	4	0.67
24007WT	7¾" x 7¾" x 1⅜", Flare Plate	Dozen	17.24	1	2	0.57
24010WT	10" x 10" x 1⅜", Flare Plate	Dozen	38.87	1	2	1.23
24012WT	12¾" x 12¾" x 2", Flare Plate	Dozen	33.09	1	1	1.02
24120WT	11¼" x 7¼" x 1", Wavy Rectangular Plate	Dozen	25.77	1	3	1.41
24140WT	13½" x 9⅝" x 1⅜", Wavy Rectangular Plate	Dozen	39.20	1	3	2.20

Classic White



39093WT



69003WT



69004WT



69005WT



69007WT



69008WT



69009WT

Item	Description	U/M	Weight Gross lbs	Inner Pack	Master Pack	Cu. Ft.
39093WT	45 oz, 9" Diameter x 3" Deep, Wavy Soup Bowl	Dozen	55.89	1	4	2.33
69003WT	2½ oz, 2⅝" x 2⅝" x 1⅜", Square Bowl	Dozen	13.21	1	8	0.94
69004WT	8 oz, 3⅞" x 3⅞" x 1¾", Square Bowl	Dozen	24.22	1	8	0.64
69005WT	22 oz, 5½" x 5½" x 2¼", Square Bowl	Dozen	35.22	1	6	1.10
69007WT	40 oz, 7⅞" x 7⅞" x 2¾", Square Bowl	Dozen	53.85	1	4	1.56
69008WT	60 oz, 8" x 8" x 3¼", Square Bowl	Dozen	33.92	1	2	1.03
69009WT	90 oz, 9" x 9" x 3⅝", Square Bowl	Dozen	48.25	1	2	1.02



CR804W



CR805W



CR806W



CR807W



39045WT



39050WT



39055WT

Item	Description	U/M	Weight Gross lbs	Inner Pack	Master Pack	Cu. Ft.
CR804W	12 oz, 6½" Diameter x 1⅞" Low Side Height (3¼" High Side Height), Cascade Bowl	Dozen	42.95	1	6	1.78
CR805W	16 oz, 8⅞" Diameter x 2¼" Low Side Height (4⅞" High Side Height), Cascade Bowl	Dozen	23.81	1	2	1.02
CR806W	24 oz, 9¼" Diameter x 2¾" Low Side Height (5" High Side Height), Cascade Bowl	Dozen	31.88	1	2	1.52
CR807W	35 oz, 10¼" Diameter x 2⅞" Low Side Height (5½" High Side Height), Cascade Bowl	Dozen	37.31	1	2	1.92
39045WT	11 oz, 4½" Diameter x 2¼" Height, Bowl	Dozen	19.75	1	4	1.04
39050WT	16 oz, 5 ⅛" Diameter x 2⅝" Height, Bowl	Dozen	20.11	1	4	1.08
39055WT	19 oz, 5⅝" Diameter x 2½" Height, Bowl	Dozen	30.31	1	4	1.50





47128WT



49095WT



49136WT



49168WT



49208WT



19035WT



19045WT



19055WT

Item	Description	U/M	Weight Gross lbs	Inner Pack	Master Pack	Cu. Ft.
47128WT	12½" x 8" x 1½", Rectangle Tray	Dozen	41.15	1	2	0.93
49095WT	9½" x 5¼" x ¾", Rectangle Tray	Dozen	28.02	1	4	0.69
49136WT	13" x 6½" x 1", Rectangle Tray	Dozen	38.32	1	3	1.01
49168WT	16½" x 8" x 1½", Rectangle Tray	Dozen	44.00	1	2	1.19
49208WT	20" x 8" x 1¾", Rectangle Tray	Dozen	35.49	1	1	0.65
19035WT	2 oz, 3½" Diameter x ¾" Deep, Round Saucer	Dozen	18.52	1	12	0.65
19045WT	4 oz, 4½" Diameter x 1" Deep, Round Saucer	Dozen	16.95	1	6	0.68
19055WT	8 oz, 5½" Diameter x 1¼" Deep, Round Saucer	Dozen	24.40	1	6	0.97



29110WT



29115WT



24110WT



19001WT



19002WT



7200WT



62008WT



63010WT

Item	Description	U/M	Weight Gross lbs	Inner Pack	Master Pack	Cu. Ft.
29110WT	10¼" x 4" x 1", Rectangular Appetizer Tray	Dozen	19.97	1	2	0.61
29115WT	15" x 5¼" x 1", Rectangular Appetizer Tray	Dozen	52.98	1	3	1.55
24110WT	11 ¼" x 5" x 1", Rectangular Plate	Dozen	33.84	1	3	1.01
19001WT	2 oz, 3¾" x 2½", Sauce Dish	Dozen	17.97	1	12	0.64
19002WT	4 oz, 6" x 3", Twin Sauce Dish	Dozen	29.61	1	12	1.27
7200WT	0.6 oz, 6¾" x 1¾", Soup Spoon	Dozen	37.93	5	60	1.74
62008WT	28 oz, 8½" x 8½" x 1½", Square Salad Bowl	Dozen	30.20	1	2	0.82
63010WT	22 oz, 10½" x 10½" x 1¾", Pasta Bowl	Dozen	37.08	1	2	1.18

****Soup Spoon is not NSF Certified.****

Arcadia

MELAMINE



Platter • Dinner Plate • Bouillon
Cup • Soup Bowl • Fruit Bowl





AD209AA



AD211AA



AD212AA



AD214AA

Item	Description	U/M	Weight Gross lbs	Inner Pack	Master Pack	Cu. Ft.
AD209AA	9½" x 7¼" x ¾", Platter	Dozen	40.92	1	6	1.26
AD211AA	11½" x 8" x ¾", Platter	Dozen	36.71	1	4	1.14
AD212AA	12" x 9" x 1", Platter	Dozen	32.52	1	3	1.15
AD214AA	14" x 10" x 7⁄8", Platter	Dozen	24.25	0.50	2	1.04



AD216AA



AD221AA



AD222AA

Item	Description	U/M	Weight Gross lbs	Inner Pack	Master Pack	Cu. Ft.
AD216AA	16 ¼" x 12" x 1 ⅜", Platter	Dozen	33.44	0.50	2	1.71
AD221AA	14 oz, 11 ½" x 8" x 1", Platter	Dozen	35.54	1	4	1.14
AD222AA	24 oz, 12" x 9" x 1 ⅜", Platter	Dozen	36.55	1	3	1.27

Arcadia



AD106AA



AD107AA



AD109AA



AD110AA

Item	Description	U/M	Weight Gross lbs	Inner Pack	Master Pack	Cu. Ft.
AD106AA	6¼" Diameter x ¾" Height, Bread Plate	Dozen	22.53	1	6	0.78
AD107AA	7½" Diameter x ¾" Height, Dinner Plate	Dozen	33.73	1	8	1.17
AD109AA	9" Diameter x ¾" Height, Dinner Plate	Dozen	37.81	1	6	1.35
AD110AA	10" Diameter x ⅞" Height, Dinner Plate	Dozen	37.43	1	4	1.25



AD305AA



AD306AA



AD307AA



AD507AA

Item	Description	U/M	Weight Gross lbs	Inner Pack	Master Pack	Cu. Ft.
AD305AA	4 oz, 5 ¼" Diameter x 1" Height, Fruit Bowl	Dozen	42.55	1	16	1.31
AD306AA	10 oz, 6¼" Diameter x 1½" Height, Salad Bowl	Dozen	33.14	1	8	1.11
AD307AA	17 oz, 7¼" Diameter x 1⅝" Height, Salad Bowl	Dozen	40.81	1	8	1.63
AD507AA	32 oz, 7½" Diameter x 2½" Height, Rim Soup Bowl	Dozen	45.11	1	8	2.35



AD918AA



AD302AA



AD908AA

Item	Description	U/M	Weight Gross lbs	Inner Pack	Master Pack	Cu. Ft.
AD918AA	9 oz, 3¼" Diameter x 3¾" Height, Round Base Cup, Two Tone	Dozen	23.04	1	5	1.55
AD302AA	7 oz, 4" Diameter x 2⅞" Height, Bouillon Cup	Dozen	26.08	1	10	1.00
AD908AA	9 oz, 3" Diameter x 3¾" Height, Cup, Two Tone	Dozen	23.56	1	5	1.63



San Marino



Platter • Dinner Plate • Bowl •
Fruit Bowl • Bread Plate • Cup



San Marino



AD209WS



AD211WS



AD212WS



AD214WS



AD216WS

Item	Description	U/M	Weight Gross lbs	Inner Pack	Master Pack	Cu. Ft.
AD209WS	9½" x 7¼" x ¾", Platter	Dozen	40.92	1	6	1.26
AD211WS	11½" x 8" x ¾", Platter	Dozen	36.71	1	4	1.14
AD212WS	12" x 9" x 1", Platter	Dozen	32.52	1	3	1.15
AD214WS	14" x 10" x ¾", Platter	Dozen	24.25	0.50	2	1.04
AD216WS	16¼" x 12" x 1¾", Platter	Dozen	33.44	0.50	2	1.71



AD221WS



AD222WS

Item	Description	U/M	Weight Gross lbs	Inner Pack	Master Pack	Cu. Ft.
AD221WS	14 oz, 11½" x 8" x 1", Platter	Dozen	35.54	1	4	1.14
AD222WS	24 oz, 12" x 9" x 1¾", Platter	Dozen	36.55	1	3	1.27



AD106WS



AD107WS



AD109WS



AD110WS

Item	Description	U/M	Weight Gross lbs	Inner Pack	Master Pack	Cu. Ft.
AD106WS	6¼" Diameter x ¾" Height, Dinner Plate	Dozen	22.53	1	6	0.78
AD107WS	7½" Diameter x ¾" Height, Dinner Plate	Dozen	33.73	1	8	1.17
AD109WS	9" Diameter x ¾" Height, Dinner Plate	Dozen	37.81	1	6	1.35
AD110WS	10" Diameter x ¾" Height, Dinner Plate	Dozen	37.43	1	4	1.25





AD507WS



AD314WS



AD304WS



AD305WS



AD306WS



AD307WS

Item	Description	U/M	Weight Gross lbs	Inner Pack	Master Pack	Cu. Ft.
AD507WS	32 oz, 7½" Diameter x 2½" Deep, Rim Soup Bowl	Dozen	45.11	1	8	2.35
AD314WS	11 oz, 4⅞" Diameter x 1¾" Height, Nappie	Dozen	24.20	1	8	1.13
AD304WS	8 oz, 4 ¼" Diameter x 2¼" Height, Bouillon Cup	Dozen	27.65	1	8	1.10
AD305WS	4 oz, 5 ¼" Diameter x 1" Height, Fruit Bowl	Dozen	42.55	1	16	1.31
AD306WS	10 oz, 6¼" Diameter x 1½" Height, Salad Bowl	Dozen	33.14	1	8	1.11
AD307WS	17 oz, 7¼" Diameter x 1⅝" Height, Salad Bowl	Dozen	40.81	1	8	1.63



AD9016WS



AD302WS



AD313WS



AD908WS



AD918WS

Item	Description	U/M	Weight Gross lbs	Inner Pack	Master Pack	Cu. Ft.
AD9016WS	10 oz, 4" Diameter x 3½" Height, Soup Mug	Dozen	29.50	1	5	1.74
AD302WS	7 oz, 4" Diameter x 2⅞" Height, Bouillon Cup	Dozen	26.08	1	10	1.00
AD313WS	5 oz, 3¾" Diameter x 2¼" Height, Dessert Dish	Dozen	11.90	1	8	0.73
AD908WS	9 oz, 3" Diameter x 3¾" Height, Cup	Dozen	23.56	1	5	1.63
AD918WS	9 oz, 3 ¼" Diameter x 3¾" Height, Round Base Cup	Dozen	23.04	1	5	1.55

Color Green

MELAMINE



Pasta Bowl • Narrow Rim Plate
• Soup Spoon • Cup • Saucer •
Soup Bowl



Color Green

2024



CR005GR



CR006GR



CR007GR



CR009GR



CR010GR



CR012GR



CR710GR

Item	Description	U/M	Weight Gross lbs	Inner Pack	Master Pack	Cu. Ft.
CR005GR	5½" Diameter x ¾" Height, Wide Rim Plate	Dozen	28.13	1	8	0.96
CR006GR	6½" Diameter x ¾" Height, Wide Rim Plate	Dozen	37.83	1	8	1.24
CR007GR	7½" Diameter x ¾" Height, Wide Rim Plate	Dozen	37.41	1	6	1.31
CR009GR	9 ¼" Diameter x 7⁄8" Height, Wide Rim Plate	Dozen	36.55	1	4	1.17
CR010GR	10 ½" Diameter x 7⁄8" Height, Wide Rim Plate	Dozen	46.72	1	4	1.56
CR012GR	11¾" Diameter x 1" Height, Wide Rim Plate	Dozen	48.90	1	4	1.90
CR710GR	10¼" Diameter x 1" Height, 3-Section Compartment Plate	Dozen	21.34	1	2	0.71



CR209GR



CR212GR



CR213GR

Item	Description	U/M	Weight Gross lbs	Inner Pack	Master Pack	Cu. Ft.
CR209GR	9½" x 7¼" x ¾", Platter	Dozen	27.56	1	4	0.87
CR212GR	12" x 9" x ¾", Platter	Dozen	44.48	1	4	1.53
CR213GR	13½" x 10½" x 1", Platter	Dozen	42.35	0.50	3	1.57

MELAMINE

Color Green

MELAMINE



CR106GR



CR107GR



CR109GR



CR110GR

Item	Description	U/M	Weight Gross lbs	Inner Pack	Master Pack	Cu. Ft.
CR106GR	6½" Diameter x ¾" Height, Narrow Rim Plate	Dozen	36.42	1	8	1.31
CR107GR	7¼" Diameter x ⅝" Height, Narrow Rim Plate	Dozen	32.54	1	6	1.07
CR109GR	9" Diameter x ⅞" Height, Narrow Rim Plate	Dozen	35.47	1	4	1.33
CR110GR	10½" Diameter x ¾" Height, Narrow Rim Plate	Dozen	41.78	1	4	1.45



CR5077GR



CR5716GR



CR5809GR



CR5810GR



CR5811GR



CR5608GR

Item	Description	U/M	Weight Gross lbs	Inner Pack	Master Pack	Cu. Ft.
CR5077GR	8 oz, 7¾" Diameter x 1½" Height, Wide Rim Salad Bowl	Dozen	48.57	1	8	1.93
CR5716GR	18 oz, 7½" Diameter x 1¾" Height, Soup Bowl	Dozen	40.45	1	6	1.56
CR5809GR	13 oz, 9¼" Diameter x 1⅜" Height, Salad Bowl	Dozen	39.64	1	4	1.42
CR5810GR	12 oz, 10¼" Diameter x 1½" Height, Pasta Bowl	Dozen	39.95	1	3	1.34
CR5811GR	16 oz, 11¼" Diameter x 1⅝" Height, Pasta Bowl	Dozen	42.13	0.50	3	2.12
CR5608GR	8 oz, 6" Diameter x 1½" Height, Salad Bowl	Dozen	41.01	1	8	1.26



CR5807GR



CR5804GR



CR5712GR



CR9016GR



CR5510GR



CR305GR



7000G

Item	Description	U/M	Weight Gross lbs	Inner Pack	Master Pack	Cu. Ft.
CR5807GR	32 oz, 7½" Diameter x 2⅝" Height, Salad Bowl	Dozen	31.75	1	4	1.35
CR5804GR	10 oz, 4⅝" Diameter x 2¼" Height, Soup Bowl	Dozen	31.75	1	6	1.43
CR5712GR	15 oz, 7¼" Diameter x 1⅞" Height, Soup Bowl	Dozen	45.55	1	6	1.57
CR9016GR	10 oz, 4" Diameter x 2⅜" Height, Soup Mug	Dozen	29.50	1	5	1.76
CR5510GR	10 oz, 5 ½" Diameter x 2½" Height, Soup Bowl	Dozen	40.76	1	8	1.67
CR305GR	10 oz, 4⅝" Diameter x 2" Height, Soup Bowl with 2½" Handle	Dozen	18.02	1	4	1.44
7000G	1 oz, 6⅜" x 1⅞", Spoon	Dozen	31.86	5	40	2.00



CR9035GR



CR9010GR



CR9018GR



CR313GR



CR5044GR



CR303GR



CR9303GR



CR9108GR



ML536GR1



ML538GR1

Item	Description	U/M	Weight Gross lbs	Inner Pack	Master Pack	Cu. Ft.
CR9035GR	10 oz, 3⅜" Diameter x 3⅞" Height, Mug	Dozen	32.23	1	5	1.74
CR9010GR	8 oz, 2⅞" Diameter x 3⅞" Height, Mug	Dozen	28.46	1	4	1.36
CR9018GR	7 oz, 3⅞" Diameter x 3⅞" Height, Mug/Cup	Dozen	48.90	1	8	2.39
CR313GR	8 oz, 4 ¼" Diameter x 2⅞" Height, Bouillon Cup	Dozen	27.71	1	8	1.10
CR5044GR	4 oz, 4 ¾" Diameter x 1⅜" Height, Salad Bowl	Dozen	23.10	1	8	0.79
CR303GR	7 oz, 4" Diameter x 2⅞" Height, Bouillon Cup	Dozen	26.68	1	8	1.19
CR9303GR	5½" Diameter x ⅝" Height, Saucer For CR303/CR9018	Dozen	37.46	1	10	1.43
CR9108GR	5½" Diameter x ¾" Height, Saucer For CR313/CR5044	Dozen	37.70	1	10	1.34
ML536GR1	2½ oz, 2⅞" Diameter x 1¾" Height, Smooth Ramekin	Dozen	48.05	1	48	2.05
ML538GR1	4 oz, 3⅜" Diameter x 1¾" Height, Smooth Ramekin	Dozen	50.71	1	24	2.49

****Soup Spoon is not NSF Certified.****

Color Ivory

MELAMINE



Compartment Plate • Wide Rim
Plate • Soup Bowl • Bouillon Cup
• Mug • Soup Spoon





CR005V



CR006V



CR007V



CR009V



CR010V



CR012V



CR710V

Item	Description	U/M	Weight Gross lbs	Inner Pack	Master Pack	Cu. Ft.
CR005V	5½" Diameter x ¾" Height, Wide Rim Plate	Dozen	28.13	1	8	0.96
CR006V	6½" Diameter x ¾" Height, Wide Rim Plate	Dozen	37.83	1	8	1.24
CR007V	7⅝" Diameter x ¾" Height, Wide Rim Plate	Dozen	37.41	1	6	1.31
CR009V	9¼" Diameter x ⅞" Height, Wide Rim Plate	Dozen	36.55	1	4	1.17
CR010V	10½" Diameter x ⅞" Height, Wide Rim Plate	Dozen	46.72	1	4	1.56
CR012V	11¾" Diameter x 1" Height, Wide Rim Plate	Dozen	48.90	1	4	1.90
CR710V	10¼" Diameter x 1" Height, 3-Section Compartment Plate	Dozen	21.34	1	2	0.71



CR209V



CR212V



CR213V

Item	Description	U/M	Weight Gross lbs	Inner Pack	Master Pack	Cu. Ft.
CR209V	9½" x 7¼" x ¾", Platter	Dozen	27.56	1	4	0.87
CR212V	12" x 9" x ¾", Platter	Dozen	44.48	1	4	1.53
CR213V	13½" x 10½" x 1", Platter	Dozen	42.35	0.50	3	1.57

Color Ivory



CR106V



CR107V



CR109V



CR110V

Item	Description	U/M	Weight Gross lbs	Inner Pack	Master Pack	Cu. Ft.
CR106V	6½" Diameter x ¾" Height, Narrow Rim Plate	Dozen	36.42	1	8	1.31
CR107V	7¼" Diameter x ⅝" Height, Narrow Rim Plate	Dozen	32.54	1	6	1.07
CR109V	9" Diameter x ⅞" Height, Narrow Rim Plate	Dozen	35.47	1	4	1.33
CR110V	10½" Diameter x ¾" Height, Narrow Rim Plate	Dozen	41.78	1	4	1.45



CR5077V



CR5716V



CR5809V



CR5810V



CR5811V



CR5608V

Item	Description	U/M	Weight Gross lbs	Inner Pack	Master Pack	Cu. Ft.
CR5077V	8 oz, 7¾" Diameter x 1½" Height, Wide Rim Salad Bowl	Dozen	48.57	1	8	1.93
CR5716V	18 oz, 7½" Diameter x 1¾" Height, Soup Bowl	Dozen	40.45	1	6	1.56
CR5809V	13 oz, 9¼" Diameter x 1¾" Height, Salad Bowl	Dozen	39.64	1	4	1.42
CR5810V	12 oz, 10¼" Diameter x 1½" Height, Pasta Bowl	Dozen	39.95	1	3	1.34
CR5811V	16 oz, 11¼" Diameter x 1⅝" Height, Pasta Bowl	Dozen	42.13	0.50	3	2.12
CR5608V	8 oz, 6" Diameter x 1½" Height, Salad Bowl	Dozen	41.01	1	8	1.26



CR5807V



CR5804V



CR5712V



CR9016V



CR5510V



CR305V



7000V

Item	Description	U/M	Weight Gross lbs	Inner Pack	Master Pack	Cu. Ft.
CR5807V	32 oz, 7½" Diameter x 2⅝" Height, Salad Bowl	Dozen	31.75	1	4	1.35
CR5804V	10 oz, 4⅝" Diameter x 2¼" Height, Soup Bowl	Dozen	31.75	1	6	1.43
CR5712V	15 oz, 7¼" Diameter x 1⅞" Height, Soup Bowl	Dozen	45.55	1	6	1.57
CR9016V	10 oz, 4" Diameter x 2⅜" Height, Soup Mug	Dozen	29.50	1	5	1.76
CR5510V	10 oz, 5 ½" Diameter x 2½" Height, Soup Bowl	Dozen	40.76	1	8	1.67
CR305V	10 oz, 4⅝" Diameter x 2" Height, Soup Bowl with 2⅞" Handle	Dozen	18.02	1	4	1.44
7000V	1 oz, 6 ⅜" x 1⅞", Spoon	Dozen	31.86	5	40	2.00



CR9035V



CR9010V



ML9011I



ML9011



CR9018V



CR313V



CR5044V



CR303V



CR9303V



CR9108V

Item	Description	U/M	Weight Gross lbs	Inner Pack	Master Pack	Cu. Ft.
CR9035V	10 oz, 3⅝" Diameter x 3⅞" Height, Mug	Dozen	32.23	1	5	1.74
CR9010V	8 oz, 2⅞" Diameter x 3⅞" Height, Mug	Dozen	28.46	1	4	1.36
ML9011I	7 oz, 3¼" Diameter x 2¾" Height, Stacking Cup	Dozen	16.25	1	5	1.42
ML9011	8 oz, 3" Diameter x 3¾" Height, Bulbous Mug	Dozen	29.59	0.50	5	1.77
CR9018V	7 oz, 3⅝" Diameter x 3⅞" Height, Mug/Cup	Dozen	48.90	1	8	2.39
CR313V	8 oz, 4 ¼" Diameter x 2⅞" Height, Bouillon Cup	Dozen	27.71	1	8	1.10
CR5044V	4 oz, 4 ¾" Diameter x 1⅞" Height, Salad Bowl	Dozen	23.10	1	8	0.79
CR303V	7 oz, 4" Diameter x 2⅞" x Height, Bouillon Cup	Dozen	26.68	1	8	1.19
CR9303V	5½" Diameter x ⅝" Height, Saucer For CR303/CR9018	Dozen	37.46	1	10	1.43
CR9108V	5½" Diameter x ¾" Height, Saucer For CR313/CR5044/ML901/ML9011	Dozen	37.70	1	10	1.34

****Soup Spoon is not NSF Certified.****

Color Orange

MELAMINE



Platter • Compartment Plate
• Soup Bowl • Soup Spoon •
Bouillon Cups • Mug • Saucer



Color Orange

2024



CR005RD



CR006RD



CR007RD



CR009RD



CR010RD



CR012RD



CR710RD

Item	Description	U/M	Weight Gross lbs	Inner Pack	Master Pack	Cu. Ft.
CR005RD	5½" Diameter x ¾" Height, Wide Rim Plate	Dozen	28.13	1	8	0.96
CR006RD	6½" Diameter x ¾" Height, Wide Rim Plate	Dozen	37.83	1	8	1.24
CR007RD	7⅝" Diameter x ¾" Height, Wide Rim Plate	Dozen	37.41	1	6	1.31
CR009RD	9¼" Diameter x ⅞" Height, Wide Rim Plate	Dozen	36.55	1	4	1.17
CR010RD	10½" Diameter x ⅞" Height, Wide Rim Plate	Dozen	46.72	1	4	1.56
CR012RD	11¾" Diameter x 1" Height, Wide Rim Plate	Dozen	48.90	1	4	1.90
CR710RD	10¼" Diameter x 1" Height, 3-Section Compartment Plate	Dozen	21.34	1	2	0.71



CR209RD



CR212RD



CR213RD

Item	Description	U/M	Weight Gross lbs	Inner Pack	Master Pack	Cu. Ft.
CR209RD	9½" x 7¼" x ¾", Platter	Dozen	27.56	1	4	0.87
CR212RD	12" x 9" x ¾", Platter	Dozen	44.48	1	4	1.53
CR213RD	13½" x 10½" x 1", Platter	Dozen	42.35	0.50	3	1.57

MELAMINE

Color Orange



CR106RD



CR107RD



CR109RD



CR110RD

Item	Description	U/M	Weight Gross lbs	Inner Pack	Master Pack	Cu. Ft.
CR106RD	6½" Diameter x ¾" Height, Narrow Rim Plate	Dozen	36.42	1	8	1.31
CR107RD	7¼" Diameter x ⅝" Height, Narrow Rim Plate	Dozen	32.54	1	6	1.07
CR109RD	9" Diameter x ⅞" Height, Narrow Rim Plate	Dozen	35.47	1	4	1.33
CR110RD	10½" Diameter x ¾" Height, Narrow Rim Plate	Dozen	41.78	1	4	1.45



CR5077RD



CR5716RD



CR5809RD



CR5810R



CR5811RD



CR5608RD

Item	Description	U/M	Weight Gross lbs	Inner Pack	Master Pack	Cu. Ft.
CR5077RD	8 oz, 7¾" Diameter x 1½" Height, Wide Rim Salad Bowl	Dozen	48.57	1	8	1.93
CR5716RD	18 oz, 7½" Diameter x 1¾" Height, Soup Bowl	Dozen	40.45	1	6	1.56
CR5809RD	13 oz, 9¼" Diameter x 1⅜" Height, Salad Bowl	Dozen	39.64	1	4	1.42
CR5810R	12 oz, 10¼" Diameter x 1½" Height, Pasta Bowl	Dozen	39.95	1	3	1.34
CR5811RD	16 oz, 11 ¼" Diameter x 1⅝" Height, Pasta Bowl	Dozen	42.13	0.50	3	2.12
CR5608RD	8 oz, 6" Diameter x 1½" Height, Salad Bowl	Dozen	41.01	1	8	1.26



Color Orange

2024



CR5807RD



CR5804RD



CR5712RD



CR9016RD



CR5510RD



CR305RD



7000R

Item	Description	U/M	Weight Gross lbs	Inner Pack	Master Pack	Cu. Ft.
CR5807RD	32 oz, 7½" Diameter x 2⅝" Height, Salad Bowl	Dozen	31.75	1	4	1.35
CR5804RD	10 oz, 4⅝" Diameter x 2¼" Height, Soup Bowl	Dozen	31.75	1	6	1.43
CR5712RD	15 oz, 7¼" Diameter x 1⅞" Height, Soup Bowl	Dozen	45.55	1	6	1.57
CR9016RD	10 oz, 4" Diameter x 2⅜" Height, Soup Mug	Dozen	29.50	1	5	1.76
CR5510RD	10 oz, 5½" Diameter x 2⅝" Height, Soup Bowl	Dozen	40.76	1	8	1.67
CR305RD	10 oz, 4⅝" Diameter x 2" Height, Soup Bowl with 2½" Handle	Dozen	18.02	1	4	1.44
7000R	1 oz, 6⅜" x 1⅞", Spoon	Dozen	31.86	5	40	2.00

****Soup Spoon is not NSF Certified.****



CR9035RD



CR9010RD



CR9018RD



CR313RD



CR5044RD



CR303RD



CR9303RD



CR9108RD



ML536RD1



ML538RD1

Item	Description	U/M	Weight Gross lbs	Inner Pack	Master Pack	Cu. Ft.
CR9035RD	10 oz, 3⅝" Diameter x 3⅝" Height, Mug	Dozen	32.23	1	5	1.74
CR9010RD	8 oz, 2⅞" Diameter x 3⅞" Height, Mug	Dozen	28.46	1	4	1.36
CR9018RD	7 oz, 3⅝" Diameter x 3⅞" Height, Mug/Cup	Dozen	48.90	1	8	2.39
CR313RD	8 oz, 4 ¼" Diameter x 2⅞" Height, Bouillon Cup	Dozen	27.71	1	8	1.10
CR5044RD	4 oz, 4 ¾" Diameter x 1⅝" Height, Salad Bowl	Dozen	23.10	1	8	0.79
CR303RD	7 oz, 4" Diameter x 2⅞" Height, Bouillon Cup	Dozen	26.68	1	8	1.19
CR9303RD	5½" Diameter x ⅝" Height, Saucer For CR303/CR9018	Dozen	37.46	1	10	1.43
CR9108RD	5½" Diameter x ¾" Height, Saucer For CR313/CR5044	Dozen	37.70	1	10	1.34
ML536RD1	2½ oz, 2⅞" Diameter x 1⅝" Height, Smooth Ramekin	Dozen	48.05	1	48	2.05
ML538RD1	4 oz, 3⅝" Diameter x 1¾" Height, Smooth Ramekin	Dozen	50.71	1	24	2.49

MELAMINE

Color Pure Red

MELAMINE



Wide Rim Plate • Compartment
Plate • Cascade Bowl • Bouillon
Cup • Platter • Ramekin



Color Pure Red

2024



CR005PR



CR006PR



CR007PR



CR009PR



CR010PR



CR012PR



CR710PR

Item	Description	U/M	Weight Gross lbs	Inner Pack	Master Pack	Cu. Ft.
CR005PR	5½" Diameter x ¾" Height, Wide Rim Plate	Dozen	28.13	1	8	0.96
CR006PR	6½" Diameter x ¾" Height, Wide Rim Plate	Dozen	37.83	1	8	1.24
CR007PR	7⅝" Diameter x ¾" Height, Wide Rim Plate	Dozen	37.41	1	6	1.31
CR009PR	¼" Diameter x ⅞" Height, Wide Rim Plate	Dozen	36.55	1	4	1.17
CR010PR	10 ½" Diameter x ⅞" Height, Wide Rim Plate	Dozen	46.72	1	4	1.56
CR012PR	11¾" Diameter x 1" Height, Wide Rim Plate	Dozen	48.90	1	4	1.90
CR710PR	10¼" Diameter x 1" Height, 3-Section Compartment Plate	Dozen	21.34	1	2	0.71



CR209PR



CR212PR



CR213PR

Item	Description	U/M	Weight Gross lbs	Inner Pack	Master Pack	Cu. Ft.
CR209PR	9 ½" x 7 ¼" x ¾", Platter	Dozen	27.56	1	4	0.87
CR212PR	12" x 9" x ¾", Platter	Dozen	44.48	1	4	1.53
CR213PR	13½" x 10½" x 1", Platter	Dozen	42.35	0.50	3	1.57

MELAMINE

Color Pure Red



CR106PR



CR107PR



CR109PR



CR110PR

Item	Description	U/M	Weight Gross lbs	Inner Pack	Master Pack	Cu. Ft.
CR106PR	6½" Diameter x ¾" Height, Narrow Rim Plate	Dozen	36.42	1	8	1.31
CR107PR	7¼" Diameter x ⅝" Height, Narrow Rim Plate	Dozen	32.54	1	6	1.07
CR109PR	9" Diameter x ⅞" Height, Narrow Rim Plate	Dozen	35.47	1	4	1.33
CR110PR	10½" Diameter x ¾" Height, Narrow Rim Plate	Dozen	41.78	1	4	1.45



CR5077PR



CR5716PR



CR5809PR



CR5810V



CR5811V



CR5608PR



CR804PR



CR805PR



CR806PR



CR807PR

Item	Description	U/M	Weight Gross lbs	Inner Pack	Master Pack	Cu. Ft.
CR5077PR	8 oz, 7¾" Diameter x 1½" Height, Wide Rim Salad Bowl	Dozen	48.57	1	8	1.93
CR5716PR	18 oz, 7½" Diameter x 1¾" Height, Soup Bowl	Dozen	40.45	1	6	1.56
CR5809PR	13 oz, 9¼" Diameter x 1⅜" Height, Salad Bowl	Dozen	39.64	1	4	1.42
CR5810PR	12 oz, 10¼" Diameter x 1½" Height, Pasta Bowl	Dozen	39.95	1	3	1.34
CR5811PR	16 oz, 11¼" Diameter x 1⅝" Height, Pasta Bowl	Dozen	42.13	0.50	3	2.12
CR5608PR	8 oz, 6" Diameter x 1½" Height, Salad Bowl	Dozen	41.01	1	8	1.26
CR804PR	12 oz, 6½" Diameter x 1⅞" Low Side Height (3¼" High Side Height), Cascade Bowl	Dozen	42.95	1	6	1.78
CR805PR	16 oz, 8⅞" Diameter x 2¼" Low Side Height (4⅞" High Side Height), Cascade Bowl	Dozen	23.81	1	2	1.02
CR806PR	24 oz, 9¼" Diameter x 2¾" Low Side Height (5" High Side Height), Cascade Bowl	Dozen	31.88	1	2	1.52
CR807PR	35 oz, 10¼" Diameter x 2⅞" Low Side Height (5½" High Side Height), Cascade Bowl	Dozen	37.31	1	2	1.92



Color Pure Red

2024



CR5807PR



CR5804PR



CR5712PR



CR9016PR



CR5510PR



CR305PR

Item	Description	U/M	Weight Gross lbs	Inner Pack	Master Pack	Cu. Ft.
CR5807PR	32 oz, 7½" Diameter x 2⅝" Height, Salad Bowl	Dozen	31.75	1	4	1.35
CR5804PR	10 oz, 4⅝" Diameter x 2¼" Height, Soup Bowl	Dozen	31.75	1	6	1.43
CR5712PR	15 oz, 7¼" Diameter x 1⅞" Height, Soup Bowl	Dozen	45.55	1	6	1.57
CR9016PR	10 oz, 4" Diameter x 2⅜" Height, Soup Mug	Dozen	29.50	1	5	1.76
CR5510PR	10 oz, 5½" Diameter x 2½" Height, Soup Bowl	Dozen	40.76	1	8	1.67
CR305PR	10 oz, 4⅝" Diameter x 2" Height, Soup Bowl with 2½" Handle	Dozen	18.02	1	4	1.44



CR9303PR



CR9108PR



CR303PR



CR313PR



CR5044PR



CR9018PR



CR9010PR



CR9035PR



ML9011PR



N-901PR



ML536PR1



ML538PR1

Item	Description	U/M	Weight Gross lbs	Inner Pack	Master Pack	Cu. Ft.
CR9303PR	5½" Diameter x ⅝" Height, Saucer For CR303/CR9018	Dozen	37.46	1	10	1.43
CR9108PR	5½" Diameter x ¾" Height, Saucer For CR313/CR5044/N-901/ML9011	Dozen	37.70	1	10	1.34
CR303PR	7 oz, 4" Diameter x 2⅞" Height, Bouillon Cup	Dozen	26.68	1	8	1.19
CR313PR	8 oz, 4 ¼" Diameter x 2⅞" Height, Bouillon Cup	Dozen	27.71	1	8	1.10
CR5044PR	4 oz, 4 ¾" Diameter x 1⅜" Height, Salad Bowl	Dozen	23.10	1	8	0.79
CR9018PR	7 oz, 3⅞" Diameter x 3⅞" Height, Mug/Cup	Dozen	48.90	1	8	2.39
CR9010PR	8 oz, 2⅞" Diameter x 3⅞" Height, Mug	Dozen	28.46	1	4	1.36
CR9035PR	10 oz, 3⅞" Diameter x 3⅞" Height, Mug	Dozen	32.23	1	5	1.74
ML9011PR	7oz, 3¼" Diameter x 2¾" Height, Stacking Cup	Dozen	16.25	1	5	1.42
N-901PR	8 oz, 3" Diameter x 3¾" Height, Bulbous Mug	Dozen	29.59	0.50	5	1.77
ML536PR1	2½ oz, 2⅞" Diameter x 1⅜" Height, Smooth Ramekin	Dozen	48.05	1	48	2.05
ML538PR1	4 oz, 3⅞" Diameter x 1¾" Height, Smooth Ramekin	Dozen	50.71	1	24	2.49

MELAMINE

55

Color Purple

MELAMINE



Platter • Compartment Plate •
Soup Bowl • Soup Spoon • Wide
Rim Plate • Mug • Saucer



Color Purple

2024



CR005BU



CR006BU



CR007BU



CR009BU



CR010BU



CR012BU



CR710BU

Item	Description	U/M	Weight Gross lbs	Inner Pack	Master Pack	Cu. Ft.
CR005BU	5½" Diameter x ¾" Height, Wide Rim Plate	Dozen	28.13	1	8	0.96
CR006BU	6½" Diameter x ¾" Height, Wide Rim Plate	Dozen	37.83	1	8	1.24
CR007BU	7½" Diameter x ¾" Height, Wide Rim Plate	Dozen	37.41	1	6	1.31
CR009BU	9¼" Diameter x 7⁄8" Height, Wide Rim Plate	Dozen	36.55	1	4	1.17
CR010BU	10½" Diameter x 7⁄8" Height, Wide Rim Plate	Dozen	46.72	1	4	1.56
CR012BU	11¾" Diameter x 1" Height, Wide Rim Plate	Dozen	48.90	1	4	1.90
CR710BU	10¼" Diameter x 1" Height, 3-Section Compartment Plate	Dozen	21.34	1	2	0.71



CR209BU



CR213BU



CR212BU

Item	Description	U/M	Weight Gross lbs	Inner Pack	Master Pack	Cu. Ft.
CR209BU	9½" x 7¼" x ¾", Platter	Dozen	27.56	1	4	0.87
CR212BU	12" x 9" x ¾", Platter	Dozen	44.48	1	4	1.53
CR213BU	13½" x 10½" x 1", Platter	Dozen	42.35	0.50	3	1.57

MELAMINE

Color Purple



CR106BU



CR107BU



CR109BU



CR110BU

Item	Description	U/M	Weight Gross lbs	Inner Pack	Master Pack	Cu. Ft.
CR106BU	6 1/2" Diameter x 3/4" Height, Narrow Rim Plate	Dozen	36.42	1	8	1.31
CR107BU	7 1/4" Diameter x 5/8" Height, Narrow Rim Plate	Dozen	32.54	1	6	1.07
CR109BU	9" Diameter x 7/8" Height, Narrow Rim Plate	Dozen	35.47	1	4	1.33
CR110BU	10 1/2" Diameter x 3/4" Height, Narrow Rim Plate	Dozen	41.78	1	4	1.45



CR5077BU



CR5716BU



CR5809BU



CR5810BU



CR5811BU



CR5608BU

Item	Description	U/M	Weight Gross lbs	Inner Pack	Master Pack	Cu. Ft.
CR5077BU	8 oz, 3/4" Diameter x 1 1/2" Height, Wide Rim Salad Bowl	Dozen	48.57	1	8	1.93
CR5716BU	18 oz, 7 1/2" Diameter x 1 3/4" Height, Soup Bowl	Dozen	40.45	1	6	1.56
CR5809BU	13 oz, 9 1/4" Diameter x 1 3/8" Height, Salad Bowl	Dozen	39.64	1	4	1.42
CR5810BU	12 oz, 10 1/4" Diameter x 1 1/2" Height, Pasta Bowl	Dozen	39.95	1	3	1.34
CR5811BU	16 oz, 11 1/4" Diameter x 1 5/8" Height, Pasta Bowl	Dozen	42.13	0.50	3	2.12
CR5608BU	8 oz, 6" Diameter x 1 1/2" Height, Salad Bowl	Dozen	41.01	1	8	1.26

Color Purple

2024



CR5807BU



CR5804BU



CR5712BU



CR9016BU



CR5510BU



CR305BU



7000B

Item	Description	U/M	Weight Gross lbs	Inner Pack	Master Pack	Cu. Ft.
CR5807BU	32 oz, 7½" Diameter x 2⅝" Height, Salad Bowl	Dozen	31.75	1	4	1.35
CR5804BU	10 oz, 4⅝" Diameter x 2¼" Height, Soup Bowl	Dozen	31.75	1	6	1.43
CR5712BU	15 oz, 7¼" Diameter x 1⅞" Height, Soup Bowl	Dozen	45.55	1	6	1.57
CR9016BU	10 oz, 4" Diameter x 2⅝" Height, Soup Mug	Dozen	29.50	1	5	1.76
CR5510BU	10 oz, 5 ½" Diameter x 2⅞" Height, Soup Bowl	Dozen	40.76	1	8	1.67
CR305BU	10 oz, 4⅝" Diameter x 2" Height, Soup Bowl with 2⅞" Handle	Dozen	18.02	1	4	1.44
7000B	1 oz, 6⅜" x 1⅞", Spoon	Dozen	31.86	5	40	2.00

****Soup Spoon is not NSF Certified.****



CR9035BU



CR9010BU



CR9018BU



CR313BU



CR5044BU



CR303BU



CR9303BU



CR9108BU



ML536BU1



ML538BU1

Item	Description	U/M	Weight Gross lbs	Inner Pack	Master Pack	Cu. Ft.
CR9035BU	10 oz, 3⅝" Diameter x 3⅞" Height, Mug	Dozen	32.23	1	5	1.74
CR9010BU	8 oz, 2⅞" Diameter x 3⅞" Height, Mug	Dozen	28.46	1	4	1.36
CR9018BU	7 oz, 3⅞" Diameter x 3⅞" Height, Mug/Cup	Dozen	48.90	1	8	2.39
CR313BU	8 oz, 4¼" Diameter x 2⅞" Height, Bouillon Cup	Dozen	27.71	1	8	1.10
CR5044BU	4 oz, 4¾" Diameter x 1⅜" Height, Salad Bowl	Dozen	23.10	1	8	0.79
CR303BU	7 oz, 4" Diameter x 2⅞" Height, Bouillon Cup	Dozen	26.68	1	8	1.19
CR9303BU	5½" Diameter x ⅝" Height, Saucer For CR303/CR9018	Dozen	37.46	1	10	1.43
CR9108BU	5½" Diameter x ¾" Height, Saucer For CR313/CR5044	Dozen	37.70	1	10	1.34
ML536BU1	2½ oz, 2⅞" Diameter x 1¼" Height, Smooth Ramekin	Dozen	48.05	1	48	2.05
ML538BU1	4 oz, 3⅜" Diameter x 1¼" Height, Smooth Ramekin	Dozen	50.71	1	24	2.49

MELAMINE

Color White

MELAMINE



Mug • Saucer • Narrow Rim Plate
Platter • Compartment Plate •
Soup Bowl • Soup Spoon





CR005W



CR006W



CR007W



CR009W



CR010W



CR012W



CR710W

Item	Description	U/M	Weight Gross lbs	Inner Pack	Master Pack	Cu. Ft.
CR005W	5½" Diameter x ¾" Height, Wide Rim Plate	Dozen	28.13	1	8	0.96
CR006W	6½" Diameter x ¾" Height, Wide Rim Plate	Dozen	37.83	1	8	1.24
CR007W	7⅝" Diameter x ¾" Height, Wide Rim Plate	Dozen	37.41	1	6	1.31
CR009W	9¼" Diameter x ⅞" Height, Wide Rim Plate	Dozen	36.55	1	4	1.17
CR010W	10 ½" Diameter x ⅞" Height, Wide Rim Plate	Dozen	46.72	1	4	1.56
CR012W	11 ¾" Diameter x 1" Height, Wide Rim Plate	Dozen	48.90	1	4	1.90
CR710W	10¼" Diameter x 1" Height, 3-Section Compartment Plate	Dozen	21.34	1	2	0.71



CR209W



CR212W



CR213W

Item	Description	U/M	Weight Gross lbs	Inner Pack	Master Pack	Cu. Ft.
CR209W	9½" x 7¼" x ¾", Platter	Dozen	27.56	1	4	0.87
CR212W	12" x 9" x ¾", Platter	Dozen	44.48	1	4	1.53
CR213W	13½" x 10½" x 1", Platter	Dozen	42.35	0.50	3	1.57

Color White



CR106W



CR107W



CR109W



CR110W

Item	Description	U/M	Weight Gross lbs	Inner Pack	Master Pack	Cu. Ft.
CR106W	6½" Diameter x ¾" Height, Narrow Rim Plate	Dozen	36.42	1	8	1.31
CR107W	7¼" Diameter x ⅝" Height, Narrow Rim Plate	Dozen	32.54	1	6	1.07
CR109W	9" Diameter x ⅞" Height, Narrow Rim Plate	Dozen	35.47	1	4	1.33
CR110W	10½" Diameter x ¾" Height, Narrow Rim Plate	Dozen	41.78	1	4	1.45



CR5077W



CR5716W



CR5809W



CR5810W



CR5811W



CR5608W

Item	Description	U/M	Weight Gross lbs	Inner Pack	Master Pack	Cu. Ft.
CR5077W	8 oz, 7¾" Diameter x 1½" Height, Wide Rim Salad Bowl	Dozen	48.57	1	8	1.93
CR5716W	18 oz, 7½" Diameter x 1¾" Height, Soup Bowl	Dozen	40.45	1	6	1.56
CR5809W	13 oz, 9¼" Diameter x 1⅜" Height, Salad Bowl	Dozen	39.64	1	4	1.42
CR5810W	12 oz, 10¼" Diameter x 1½" Height, Pasta Bowl	Dozen	39.95	1	3	1.34
CR5811W	16 oz, 11¼" Diameter x 1⅝" Height, Pasta Bowl	Dozen	42.13	0.50	3	2.12
CR5608W	8 oz, 6" Diameter x 1½" Height, Salad Bowl	Dozen	41.01	1	8	1.26



CR5807W



CR5804W



CR5712W



CR9016W



CR5510W



CR305W



7000W

Item	Description	U/M	Weight Gross lbs	Inner Pack	Master Pack	Cu. Ft.
CR5807W	32 oz, 7½" Diameter x 2⅝" Height, Salad Bowl	Dozen	31.75	1	4	1.35
CR5804W	10 oz, 4⅝" Diameter x 2¼" Height, Soup Bowl	Dozen	31.75	1	6	1.43
CR5712W	15 oz, 7¼" Diameter x 1⅞" Height, Soup Bowl	Dozen	45.55	1	6	1.57
CR9016W	10 oz, 4" Diameter x 2⅜" Height, Soup Mug	Dozen	29.50	1	5	1.76
CR5510W	10 oz, 5 ½" Diameter x 2⅝" Height, Soup Bowl	Dozen	40.76	1	8	1.67
CR305W	10 oz, 4⅝" Diameter x 2" Height, Soup Bowl with 2⅞" Handle	Dozen	18.02	1	4	1.44
7000W	1 oz, 6⅜" x 1⅞", Spoon	Dozen	31.86	5	40	2.00

****Soup Spoon is not NSF Certified.****



CR9035W



CR9010W



ML9011W



CR901W



CR9018W



CR313W



CR5044W



CR303W



CR9303W



CR9108W

Item	Description	U/M	Weight Gross lbs	Inner Pack	Master Pack	Cu. Ft.
CR9035W	10 oz, 3⅜" Diameter x 3⅞" Height, Mug	Dozen	32.23	1	5	1.74
CR9010W	8 oz, 2⅞" Diameter x 3⅞" Height, Mug	Dozen	28.46	1	4	1.36
ML9011W	7 oz, 3¼" Diameter x 2¾" Height, Stacking Cup	Dozen	16.25	1	5	1.42
ML901W	8 oz, 3" Diameter x 3¾" Height, Bulbous Mug	Dozen	29.59	0.50	5	1.77
CR9018W	7 oz, 3⅞" Diameter x 3⅞" Height, Mug/Cup	Dozen	48.90	1	8	2.39
CR313W	8 oz, 4¼" Diameter x 2¼" Height, Bouillon Cup	Dozen	27.71	1	8	1.10
CR5044W	4 oz, 4¾" Diameter x 1⅜" Height, Salad Bowl	Dozen	23.10	1	8	0.79
CR303W	7 oz, 4" Diameter x 2⅝" Height, Bouillon Cup	Dozen	26.68	1	8	1.19
CR9303W	5½" Diameter x ⅝" Height, Saucer For CR303/CR9018	Dozen	37.46	1	10	1.43
CR9108W	5½" Diameter x ¾" Height, Saucer For CR313/CR5044/ML901/ML9011	Dozen	37.70	1	10	1.34

Color Yellow

MELAMINE



Salad Bowl • Platter • Wide Rim
Plates • Cascade Bowl • Mug





Item	Description	U/M	Weight Gross lbs	Inner Pack	Master Pack	Cu. Ft.
CR005YW	5½" Diameter x ¾" Height, Wide Rim Plate	Dozen	28.13	1	8	0.96
CR006YW	6 ½" Diameter x ¾" Height, Wide Rim Plate	Dozen	37.83	1	8	1.24
CR007YW	7¾" Diameter x ¾" Height, Wide Rim Plate	Dozen	37.41	1	6	1.31
CR009YW	9¼" Diameter x ¾" Height, Wide Rim Plate	Dozen	36.55	1	4	1.17
CR010YW	10½" Diameter x ¾" Height, Wide Rim Plate	Dozen	46.72	1	4	1.56
CR012YW	11¾" Diameter x 1" Height, Wide Rim Plate	Dozen	48.90	1	4	1.90
CR710YW	10¼" Diameter x 1" Height, 3-Section Compartment Plate	Dozen	21.34	1	2	0.71



Item	Description	U/M	Weight Gross lbs	Inner Pack	Master Pack	Cu. Ft.
CR209YW	9 ½" x 7 ¼" x ¾", Platter	Dozen	27.56	1	4	0.87
CR212YW	12" x 9" x ¾", Platter	Dozen	44.48	1	4	1.53
CR213YW	13½" x 10½" x 1", Platter	Dozen	42.35	0.50	3	1.57

Color Yellow



CR106YW



CR110YW



CR109YW



CR9010YW

Item	Description	U/M	Weight Gross lbs	Inner Pack	Master Pack	Cu. Ft.
CR106YW	6½" Diameter x ¾" Height, Narrow Rim Plate	Dozen	36.42	1	8	1.31
CR107YW	7¼" Diameter x ⅝" Height, Narrow Rim Plate	Dozen	32.54	1	6	1.07
CR109YW	9" Diameter x ⅞" Height, Narrow Rim Plate	Dozen	35.47	1	4	1.33
CR110YW	1 ½" Diameter x ¾" Height, Narrow Rim Plate	Dozen	41.78	1	4	1.45



CR5077YW



CR5716YW



CR5809YW



CR5810YW



CR5811YW



CR5608YW



CR804YW



CR805YW



CR806YW



CR807YW

Item	Description	U/M	Weight Gross lbs	Inner Pack	Master Pack	Cu. Ft.
CR5077YW	8 oz, 7¾" Diameter x 1½" Height, Wide Rim Salad Bowl	Dozen	48.57	1	8	1.93
CR5716YW	18 oz, 7½" Diameter x 1¾" Height, Soup Bowl	Dozen	40.45	1	6	1.56
CR5809YW	13 oz, 9¼" Diameter x 1¾" Height, Salad Bowl	Dozen	39.64	1	4	1.42
CR5810YW	12 oz, 10¼" Diameter x 1½" Height, Pasta Bowl	Dozen	39.95	1	3	1.34
CR5811YW	16 oz, 11¼" Diameter x 1⅝" Height, Pasta Bowl	Dozen	42.13	0.50	3	2.12
CR5608YW	8 oz, 6" Diameter x 1½" Height, Salad Bowl	Dozen	41.01	1	8	1.26
CR804YW	12 oz, 6½" Diameter x 1⅞" Low Side Height (¾" High Side Height), Cascade Bowl	Dozen	42.95	1	6	1.78
CR805YW	16 oz, 8⅞" Diameter x 2¼" Low Side Height (4⅞" High Side Height), Cascade Bowl	Dozen	23.81	1	2	1.02
CR806YW	24 oz, 9¼" Diameter x 2¾" Low Side Height (5" High Side Height), Cascade Bowl	Dozen	31.88	1	2	1.52
CR807YW	35 oz, 10¼" Diameter x 2⅞" Low Side Height (5½" High Side Height), Cascade Bowl	Dozen	37.31	1	2	1.92



Color Yellow

2024



CR5807YW



CR5804YW



CR5712YW



CR5510YW



CR305YW



7000W



CR9016YW

Item	Description	U/M	Weight Gross lbs	Inner Pack	Master Pack	Cu. Ft.
CR5807YW	32 oz, 7½" Diameter x 2⅝" Height, Salad Bowl	Dozen	31.75	1	4	1.35
CR5804YW	10 oz, 4⅝" Diameter x 2¼" Height, Soup Bowl	Dozen	31.75	1	6	1.43
CR5712YW	15 oz, 7¼" Diameter x 1⅞" Height, Soup Bowl	Dozen	45.55	1	6	1.57
CR5510YW	10 oz, 5 ½" Diameter x 2⅞" Height, Soup Bowl	Dozen	40.76	1	8	1.67
CR305YW	10 oz, 4⅝" Diameter x 2" Height, Soup Bowl with 2⅞" Handle	Dozen	18.02	1	4	1.44
7000Y	1 oz, 6⅜" x 1⅞", Spoon	Dozen	31.86	5	40	2.00
CR9016YW	10 oz, 4" Diameter x 2⅜" Height, Soup Mug	Dozen	29.50	1	5	1.76

****Soup Spoon is not NSF Certified.****



CR9035YW



CR9010YW



CR9018YW



CR313YW



CR5044YW



CR303YW



CR9303YW



CR9108YW



ML536YW1



ML538YW1

Item	Description	U/M	Weight Gross lbs	Inner Pack	Master Pack	Cu. Ft.
CR9035YW	10 oz, 3⅝" Diameter x 3⅞" Height, Mug	Dozen	32.23	1	5	1.74
CR9010YW	8 oz, 2⅞" Diameter x 3⅞" Height, Mug	Dozen	28.46	1	4	1.36
CR9018YW	7 oz, 3⅝" Diameter x 3⅞" Height, Mug/Cup	Dozen	48.90	1	8	2.39
CR313YW	8 oz, 4 ¼" Diameter x 2⅞" Height, Bouillon Cup	Dozen	27.71	1	8	1.10
CR5044YW	4 oz, 4 ¾" Diameter x 1⅞" Height, Salad Bowl	Dozen	23.10	1	8	0.79
CR303YW	7 oz, 4" Diameter x 2⅞" Height, Bouillon Cup	Dozen	26.68	1	8	1.19
CR9303YW	5½" Diameter x ⅝" Height, Saucer For CR303/CR9018	Dozen	37.46	1	10	1.43
CR9108YW	5½" Diameter x ¾" Height, Saucer For CR313/CR5044	Dozen	37.70	1	10	1.34
ML536YW1	2½ oz, 2 ⅞" Diameter x 1⅞" Height, Smooth Ramekin	Dozen	48.05	1	48	2.05
ML538YW1	4 oz, 3⅞" Diameter x 1¾" Height, Smooth Ramekin	Dozen	50.71	1	24	2.49

MELAMINE

Nustone Tan

MELAMINE



Stacking Cup • Saucer
Platter • Compartment Plate •
Soup Bowl • Cereal Bowl





NS105T



NS106T



NS107T



NS108T



NS109T



NS110T

Item	Description	U/M	Weight Gross lbs	Inner Pack	Master Pack	Cu. Ft.
NS105T	5½" Diameter x ⅝" Height, Round Plate	Dozen	36.24	1	20	2.05
NS106T	6½" Diameter x ⅝" Height, Round Plate	Dozen	52.78	1	20	2.38
NS107T	7¼" Diameter x ¾" Height, Dessert Plate	Dozen	38.94	1	10	1.71
NS108T	8" Diameter x ¾" Height, Dinner Plate	Dozen	34.26	1	8	1.49
NS109T	9" Diameter x ¾" Height, Dinner Plate	Dozen	43.89	1	8	1.98
NS110T	10¼" Diameter x 1" Height, Dinner Plate	Dozen	47.74	1	6	2.25



Item	Description	U/M	Weight Gross lbs	Inner Pack	Master Pack	Cu. Ft.
NS701T	8¾" Diameter x 1¼" Height, 3-Section Deep Compartment Plate	Dozen	46.30	0.50	6	3.76
NS702T	10" Diameter x ¾" Height, 3-Section Compartment Plate	Dozen	35.27	1	6	1.68
NS703T	10¼" Diameter x ¾" Height, 3-Section Compartment Plate	Dozen	22.93	0.50	3	1.53
NS608T	8¼" Diameter x 1¼" Height, Tortilla Server with Lid	Dozen	70.50	2	6	4.49
NS608-1T	8¼" Diameter x 1¼" Height, 3-Section Deep Divided Server, Tan (Lid Sold Separately)	Dozen	47.30	0.50	6	1.59
NS608CT	8¼" Diameter, Lid Only, Fits NS608-1T, Tan	Dozen	32.12	0.50	6	1.97
NS608-1R	8¼" Diameter x 1¼" Height, 3-Section Deep Divided Server, Red (Lid Sold Separately)	Dozen	47.30	0.50	6	1.59
NS608CR	8¼" Diameter, Lid Only, Fits NS608-1R, Red	Dozen	32.12	0.50	6	1.97
NS608R	8 ¼" Diameter x 1¼" Height, Tortilla Server with Lid, Red	Dozen	70.50	0.50	6	4.49

Nustone Tan

MELAMINE



NS510T



NS512T



NS513T



NS515T



NS516T

Item	Description	U/M	Weight Gross lbs	Inner Pack	Master Pack	Cu. Ft.
NS510T	9½" x 6¾" x 7⁄8", Narrow Rim Platter	Dozen	19.05	1	4	0.87
NS512T	11½" x 8" x 1", Narrow Rim Platter	Dozen	22.77	0.50	3	1.13
NS513T	13" x 8½" x 1", Narrow Rim Platter	Dozen	27.56	0.50	3	1.41
NS515T	13¼" x 9⁵⁄₈" x 1½", Narrow Rim Platter	Dozen	22.31	0.50	2	1.27
NS516T	15½" x 10⁷⁄₈" x 1½", Narrow Rim Platter	Dozen	31.53	0.50	2	1.59



NS209T



NS211T



NS212T



NS215T

Item	Description	U/M	Weight Gross lbs	Inner Pack	Master Pack	Cu. Ft.
NS209T	9½" x 6¾" x 5⁄₈", Rectangular Platter	Dozen	48.50	1	10	1.74
NS211T	11½" x 1½" x ¾", Rectangular Platter	Dozen	45.19	1	6	1.74
NS212T	12½" x 9" x 7⁄₈", Rectangular Platter	Dozen	53.57	1	6	2.21
NS215T	15" x 10 5⁄₈" x 7⁄₈", Rectangular Platter	Dozen	47.62	0.50	3	2.04

Nustone Tan

2024



Item	Description	U/M	Weight Gross lbs	Inner Pack	Master Pack	Cu. Ft.
NS5060T	22 oz, 6 ⁷ / ₈ " Diameter x 2 ¹ / ₄ " Height, Rimless Bowl	Dozen	37.92	1	8	2.07
NS5065T	32 oz, 7 ¹ / ₂ " Diameter x 2 ¹ / ₂ " Height, Rimless Bowl	Dozen	43.98	1	8	2.59
NS5070T	41 oz, 8" Diameter x 2 ⁵ / ₈ " Height, Rimless Bowl	Dozen	41.45	1	6	2.10
NS5075T	52 oz, 8 ³ / ₄ " Diameter x 2 ⁷ / ₈ " Height, Rimless Bowl	Dozen	47.18	1	6	2.43
NS5085T	70 oz, 9 ³ / ₄ " Diameter x 3 ¹ / ₄ " Height, Rimless Bowl	Dozen	48.06	0.50	4	3.24
NS5095T	96 oz, 11" Diameter x 3 ¹ / ₄ " Height, Rimless Bowl	Dozen	51.15	0.50	3	3.66



Item	Description	U/M	Weight Gross lbs	Inner Pack	Master Pack	Cu. Ft.
NS502T	2 ¹ / ₂ oz, 2 ⁷ / ₈ " Diameter x 1 ¹ / ₂ " Height, Sauce Cup/Ramkin	Dozen	25.26	1	20	1.11
NS503T	4 oz, 3 ¹ / ₄ " Diameter x 1 ¹ / ₂ " Height, Sauce Cup/Ramekin	Dozen	34.06	1	20	1.58
ML9011T	7 oz, 3 ¹ / ₄ " Diameter x 2 ³ / ₄ " Height, Stacking Cup	Dozen	16.25	1	5	1.42
ML901I	8 oz, 3" Diameter x 3 ³ / ₄ " Height, Bulbous Mug, Ivory	Dozen	29.59	0.50	5	1.77
ML901S	8 oz, 3" Diameter x 3 ³ / ₄ " Height, Bulbous Mug, Sand	Dozen	29.59	0.50	5	1.77
ML901T	8 oz, 3" Diameter x 3 ³ / ₄ " Height, Bulbous Mug, Tan	Dozen	29.59	0.50	5	1.77
NS302T	8 oz, 3 ⁷ / ₈ " Diameter x 2 ¹ / ₈ " Height, Bouillon Cup	Dozen	34.83	1	16	1.31
NS303T	4 oz, 4 ³ / ₄ " Diameter x 1 ¹ / ₄ " Height, Fruit Bowl	Dozen	30.42	1	16	1.33
NS304T	5 oz, 4 ³ / ₄ " Diameter x 1 ⁵ / ₈ " Height, Fruit Bowl	Dozen	32.56	1	16	1.57
NS305T	10 oz, 5 ¹ / ₂ " Diameter x 1 ⁷ / ₈ " Height, Grapefruit Bowl	Dozen	24.67	1	8	1.34
NS306T	13 oz, 5 ³ / ₄ " Diameter x 2 ¹ / ₈ " Height, Grapefruit Bowl	Dozen	25.29	1	8	1.45
NS307T	12 oz, 6 ³ / ₈ " Diameter x 1 ⁵ / ₈ " Height, Soup/Cereal Bowl	Dozen	53.35	1	10	1.25
NS314T	11 oz, 4 ⁷ / ₈ " Diameter x 1 ³ / ₄ " Height, Nappie	Dozen	25.37	1	8	1.13
NS315T	15 oz, 5 ¹ / ₄ " Diameter x 2 ¹ / ₈ " Height, Nappie	Dozen	27.56	1	8	1.43

MELAMINE

Nustone White

MELAMINE



Rectangular Platter •
Compartment Plate • Nappie •
Dinner Plate • Fruit Bowl



Nustone White

2024



Item	Description	U/M	Weight Gross lbs	Inner Pack	Master Pack	Cu. Ft.
NS105W	5 1/2" Diameter x 5/8" Height, Round Plate	Dozen	36.24	1	20	2.05
NS106W	6 1/2" Diameter x 5/8" Height, Round Plate	Dozen	52.78	1	20	2.38
NS107W	7 1/4" Diameter x 3/4" Height, Dessert Plate	Dozen	38.94	1	10	1.71
NS108W	8" Diameter x 3/4" Height, Dinner Plate	Dozen	34.26	1	8	1.49
NS109W	9" Diameter x 3/4" Height, Dinner Plate	Dozen	43.89	1	8	1.98
NS110W	10 1/4" Diameter x 1" Height, Dinner Plate	Dozen	47.74	1	6	2.25



Item	Description	U/M	Weight Gross lbs	Inner Pack	Master Pack	Cu. Ft.
NS701W	8 3/4" Diameter x 1 1/4" Height, 3-Section Compartment Plate	Dozen	46.30	0.50	6	3.76
NS702W	10" Diameter x 3/4" Height, 3-Section Compartment Plate	Dozen	35.27	1	6	1.68
NS703W	10 1/4" Diameter x 3/4" Height, 3-Section Compartment Plate	Dozen	22.93	0.50	3	1.53
NS608W	8 1/4" Diameter x 1 1/4" Height, Tortilla Server with Lid	Dozen	70.50	2	6	4.49
NS608-1W	8 1/4" Diameter x 1 1/4" Height, Deep Divided Server (Lid Sold Separately)	Dozen	47.30	0.50	6	1.59
NS608CW	8 1/4" Diameter, Fits N608-1W(Lid Only)	Dozen	32.12	0.50	6	1.97

MELAMINE

Nustone White

MELAMINE



NS510W



NS512W



NS513W



NS515W



NS516W

Item	Description	U/M	Weight Gross lbs	Inner Pack	Master Pack	Cu. Ft.
NS510W	9½" x 6¾" x 7⁄8", Narrow Rim Platter	Dozen	19.05	1	4	0.87
NS512W	11½" x 8" x 1", Narrow Rim Platter	Dozen	22.77	0.50	3	1.13
NS513W	13" x 8½" x 1", Narrow Rim Platter	Dozen	27.56	0.50	3	1.41
NS515W	13 ¼" x 9⁵⁄₈" x 1 1⁄₈", Narrow Rim Platter	Dozen	22.31	0.50	2	1.27
NS516W	15½" x 10⁷⁄₈" x 1 1⁄₈", Narrow Rim Platter	Dozen	31.53	0.50	2	1.59



NS209W



NS211W



NS212W



NS215W

Item	Description	U/M	Weight Gross lbs	Inner Pack	Master Pack	Cu. Ft.
NS209W	9½" x 6¾" x 5⁄₈", Rectangular Platter	Dozen	48.50	1	10	1.74
NS211W	11½" x 7½" x ¾", Rectangular Platter	Dozen	45.19	1	6	1.74
NS212W	12½" x 9" x 7⁄₈", Rectangular Platter	Dozen	53.57	1	6	2.21
NS215W	15" x 10⁵⁄₈" x 7⁄₈", Rectangular Platter	Dozen	47.62	0.50	3	2.04





Item	Description	U/M	Weight Gross lbs	Inner Pack	Master Pack	Cu. Ft.
NS5060W	22 oz, 6 ⁷ / ₈ " Diameter x 2 ¹ / ₄ " Height, Rimless Bowl	Dozen	37.92	1	8	2.07
NS5065W	32 oz, 7 ¹ / ₂ " Diameter x 2 ¹ / ₂ " Height, Rimless Bowl	Dozen	43.98	1	8	2.59
NS5070W	41 oz, 8" Diameter x 2 ⁵ / ₈ " Height, Rimless Bowl	Dozen	41.45	1	6	2.10
NS5075W	52 oz, 8 ³ / ₄ " Diameter x 2 ⁷ / ₈ " Height, Rimless Bowl	Dozen	47.18	1	6	2.43
NS5085W	70 oz, 9 ³ / ₄ " Diameter x 3 ¹ / ₄ " Height, Rimless Bowl	Dozen	48.06	0.50	4	3.24
NS5095W	96 oz, 11" Diameter x 3 ³ / ₄ " Height, Rimless Bowl	Dozen	51.15	0.50	3	3.66



Item	Description	U/M	Weight Gross lbs	Inner Pack	Master Pack	Cu. Ft.
NS502W	2 ¹ / ₂ oz, 2 ⁷ / ₈ " Diameter x 1 ¹ / ₂ " Height, Sauce Cup/Ramekin	Dozen	25.26	1	20	1.11
NS503W	4 oz, 3 ¹ / ₄ " Diameter x 1 ¹ / ₂ " Height, Sauce Cup/Ramekin	Dozen	34.06	1	20	1.58
NS302W	8 oz, 3 ⁷ / ₈ " Diameter x 2 ¹ / ₈ " Height, Bouillon Cup	Dozen	34.83	1	16	1.31
NS303W	4 oz, 4 ³ / ₄ " Diameter x 1 ¹ / ₄ " Height, Fruit Bowl	Dozen	30.42	1	16	1.33
NS304W	5 oz, 4 ³ / ₄ " Diameter x 1 ⁵ / ₈ " Height, Fruit Bowl	Dozen	32.56	1	16	1.57
NS305W	10 oz, 5 ¹ / ₂ " Diameter x 1 ⁷ / ₈ " Height, Grapefruit Bowl	Dozen	24.67	1	8	1.34
NS306W	13 oz, 5 ³ / ₄ " Diameter x 2" Height, Grapefruit Bowl	Dozen	25.29	1	8	1.45
NS307W	12 oz, 6 ³ / ₈ " Diameter x 1 ⁵ / ₈ " Height, Soup/Cereal Bowl	Dozen	53.35	1	10	1.25
NS314W	11 oz, 4 ⁷ / ₈ " Diameter x 1 ³ / ₄ " Height, Nappie	Dozen	25.37	1	8	1.13
NS315W	15 oz, 5 ¹ / ₄ " Diameter x 2 ¹ / ₈ " Height, Nappie	Dozen	27.56	1	8	1.43

Graham Dinnerware



Wide Rim Plate • Platter • Salad Bowls
- Crackle Design -



Graham Dinnerware

2024



DM005H

DM006H

DM007H

DM009H

DM010H

DM012H

Item	Description	U/M	Weight Gross lbs	Inner Pack	Master Pack	Cu. Ft.
DM005H	5½" Diameter x ¾" Height, Wide Rim Plate	Dozen	28.13	1	8	0.96
DM006H	6½" Diameter x ¾" Height, Wide Rim Plate	Dozen	37.83	1	8	1.24
DM007H	7⅝" Diameter x ¾" Height, Wide Rim Plate	Dozen	37.41	1	6	1.31
DM009H	9¼" Diameter x ⅞" Height, Wide Rim Plate	Dozen	36.55	1	4	1.17
DM010H	10½" Diameter x ⅞" Height, Wide Rim Plate	Dozen	46.72	1	4	1.56
DM012H	11¾" Diameter x 1" Height, Wide Rim Plate	Dozen	48.90	1	4	1.90



DM5811H



DM5608H



DM5044H



DM5807H

Item	Description	U/M	Weight Gross lbs	Inner Pack	Master Pack	Cu. Ft.
DM5811H	16 oz, 11¼" Diameter x 1⅝" Height, Pasta Bowl	Dozen	42.13	0.50	3	2.12
DM5608H	8 oz, 6" Diameter x 1½" Height, Salad Bowl	Dozen	41.01	1	8	1.26
DM5044H	4 oz, 4¾" Diameter x 1⅜" Height, Salad Bowl	Dozen	23.10	1	8	0.79
DM5807H	32 oz, 7½" Diameter x 2⅝" Height, Salad Bowl	Dozen	31.75	1	4	1.35



DM209H



DM212H



DM213H

Item	Description	U/M	Weight Gross lbs	Inner Pack	Master Pack	Cu. Ft.
DM209H	9½" x 7¼" x ¾", Platter	Dozen	27.56	1	4	0.87
DM212H	12" x 9" x ⅞", Platter	Dozen	44.48	1	4	1.53
DM213H	13½" x 10½" x 1", Platter	Dozen	42.35	0.50	3	1.57

MELAMINE

Graham Serving



Platter • Deep Bowl • Bowl with Handle • Tray
- Crackle Design -



Graham Serving and Display

2024



SD2118H



SD2121H

Item	Description	U/M	Weight Gross lbs	Inner Pack	Master Pack	Cu. Ft.
SD2118H	18" x 13 1/2" x 1 1/2", Oval Platter	Each	30.56	2	12	2.03
SD2121H	21" x 15" x 1 5/8", Oval Platter	Each	31.04	2	12	2.68



SD5609H



SD5613H



SD5612H



SD5614H



SD6015H



SD6018H

Item	Description	U/M	Weight Gross lbs	Inner Pack	Master Pack	Cu. Ft.
SD5609H	1 qt/32 oz, 8" Diameter x 2 1/4" Deep, Bowl with 1" Handle	Each	17.24	6	24	1.05
SD5612H	2 qt/64 oz, 11" Diameter x 3" Deep, Bowl with 1 1/4" Handle	Each	37.88	6	24	2.42
SD5613H	3 qt/96 oz, 12 1/4" Diameter x 3 1/4" Deep, Bowl with 1 1/4" Handle	Each	45.30	6	24	2.93
SD5614H	4 qt/128 oz, 12 7/8" Diameter x 3 1/2" Deep, Bowl with 1 1/4" Handle	Each	26.39	6	12	1.72
SD6015H	6 qt/192 oz, 12 1/4" Diameter x 4" Deep, Bowl with 1 3/8" Handle	Each	29.56	6	12	3.06
SD6018H	10 qt/320 oz, 14 3/4" Diameter x 4 3/4" Deep, Bowl with 1 5/8" Handle	Each	42.24	6	12	4.28

MELAMINE

Graham Serving and Display

MELAMINE

SD3324H



Item	Description	U/M	Weight Gross lbs	Inner Pack	Master Pack	Cu. Ft.
SD3324H	24" x 18" x 1¾", Rectangular Tray	Each	66.32	2	12	4.85

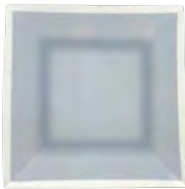

SD3206H

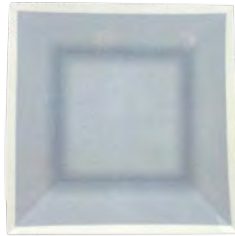

SD3208H

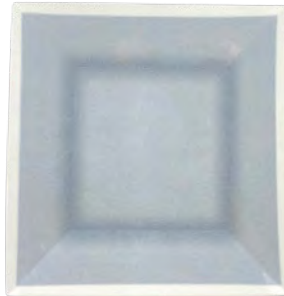

SD3210H

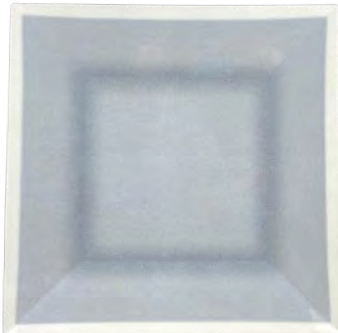

SD3212H

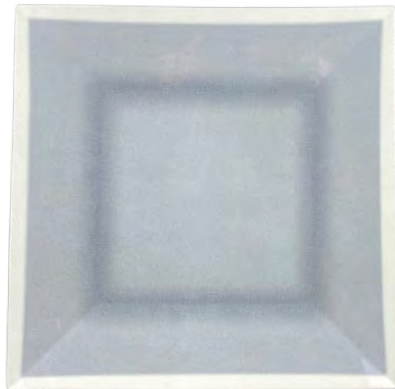

SD3214H

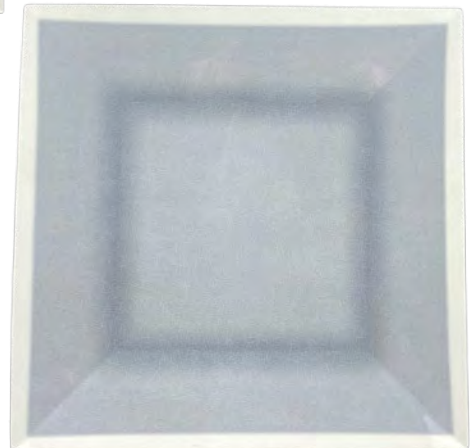

SD3216H



SD3314H



SD3318H

Item	Description	U/M	Weight Gross lbs	Inner Pack	Master Pack	Cu. Ft.
SD3206H	6" x 6" x ¾", Square Plate	Each	19.31	12	48	0.51
SD3208H	8" x 8" x 1", Square Plate	Each	34.33	12	48	0.86
SD3210H	10" x 10" x 1½", Square Plate	Each	48.70	12	48	1.40
SD3212H	12" x 12" x 1¼", Square Plate	Each	41.60	6	24	1.39
SD3214H	14" x 14" x 1¼", Square Plate	Each	29.85	6	12	1.33
SD3216H	16" x 16" x 1¾", Square Plate	Each	41.62	6	12	1.56
SD3314H	96 oz, 13¾" x 9½" x 2⅜", Tray	Each	53.95	6	24	1.97
SD3318H	58 oz, 17½" x 6¾" x 1¾", Tray	Each	40.92	6	24	1.37



Jazz Dinnerware



Platter • Pasta Bowl • Salad Bowls
- Crackle Design -



Jazz Dinnerware

MELAMINE



DM005J

DM006J

DM007J

DM009J

DM010J

DM012J

Item	Description	U/M	Weight Gross lbs	Inner Pack	Master Pack	Cu. Ft.
DM005J	5½" Diameter x ¾" Height, Wide Rim Plate	Dozen	28.13	1	8	0.96
DM006J	6½" Diameter x ¾" Height, Wide Rim Plate	Dozen	37.83	1	8	1.24
DM007J	7½" Diameter x ¾" Height, Wide Rim Plate	Dozen	37.41	1	6	1.31
DM009J	9¼" Diameter x 7⁄8" Height, Wide Rim Plate	Dozen	36.55	1	4	1.17
DM010J	10½" Diameter x 7⁄8" Height, Wide Rim Plate	Dozen	46.72	1	4	1.56
DM012J	11¾" Diameter x 1" Height, Wide Rim Plate	Dozen	48.90	1	4	1.90



DM5807J



DM5608J



DM5811J



DM5044J

Item	Description	U/M	Weight Gross lbs	Inner Pack	Master Pack	Cu. Ft.
DM5807J	32 oz, 7½" Diameter x 2⅝" Height, Salad Bowl	Dozen	31.75	1	4	1.35
DM5608J	8 oz, 6" Diameter x 1½" Height, Salad Bowl	Dozen	41.01	1	8	1.26
DM5811J	16 oz, 11¼" Diameter x 1⅝" Height, Pasta Bowl	Dozen	42.13	0.50	3	2.12
DM5044J	4 oz, 4¾" Diameter x 1⅜" Height, Salad Bowl	Dozen	23.10	1	8	0.79



DM209J



DM212J



DM213J

Item	Description	U/M	Weight Gross lbs	Inner Pack	Master Pack	Cu. Ft.
DM209J	9½" x 7¼" x ¾", Platter	Dozen	27.56	1	4	0.87
DM212J	12" x 9" x 7⁄8", Platter	Dozen	44.48	1	4	1.53
DM213J	13½" x 10½" x 1", Platter	Dozen	42.35	0.50	3	1.57



Jazz Serving



Platter • Rectangle Tray •
Deep Bowl with Handle • Square Plates
- Crackle Design -



Jazz Serving and Display

MELAMINE



SD2118J



SD2121J

Item	Description	U/M	Weight Gross lbs	Inner Pack	Master Pack	Cu. Ft.
SD2118J	18" x 13 1/2" x 1 1/2", Oval Platter	Each	30.56	2	12	2.03
SD2121J	21" x 15" x 1 3/8", Oval Platter	Each	31.04	2	12	2.68



SD5609J



SD5613J



SD5612J



SD5614J



SD6015J



SD6018J

Item	Description	U/M	Weight Gross lbs	Inner Pack	Master Pack	Cu. Ft.
SD5609J	1 qt/32 oz, 8" Diameter x 2 1/4" Deep, Bowl with 1" Handle	Each	17.24	6	24	1.05
SD5612J	2 qt/64 oz, 11" Diameter x 3" Deep, Bowl with 1 1/4" Handle	Each	37.88	6	24	2.42
SD5613J	3 qt/96 oz, 12 1/4" Diameter x 3 1/4" Deep, Bowl with 1 1/4" Handle	Each	45.30	6	24	2.93
SD5614J	4 qt/128 oz, 12 7/8" Diameter x 3 1/2" Deep, Bowl with 1 1/4" Handle	Each	26.39	6	12	1.72
SD6015J	6 qt/192 oz, 12 1/4" Diameter x 4" Deep, Bowl with 1 3/8" Handle	Each	29.56	6	12	3.06
SD6018J	10 qt/320 oz, 14 3/4" Diameter x 4 3/4" Deep, Bowl with 1 5/8" Handle	Each	42.24	6	12	4.28



Jazz Serving and Display

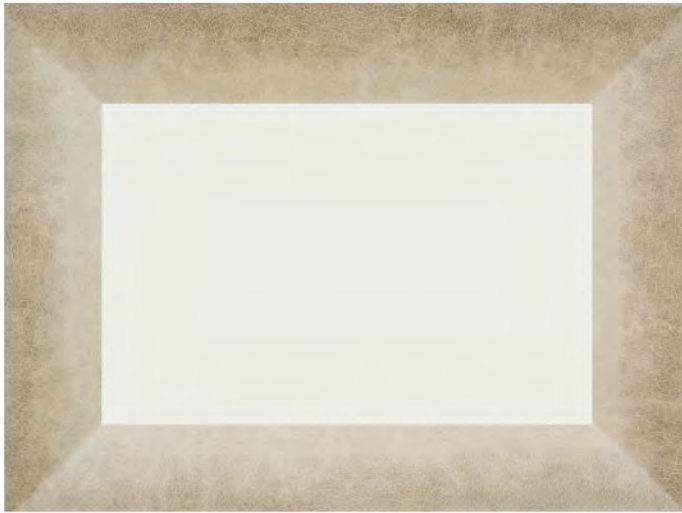

SD3324J

Item	Description	U/M	Weight Gross lbs	Inner Pack	Master Pack	Cu. Ft.
SD3324J	24" x 18" x 1¾", Rectangular Tray	Each	66.32	2	12	4.85



SD3206J



SD3208J



SD3210J



SD3212J



SD3214J



SD3216J



SD3314J



SD3318J

Item	Description	U/M	Weight Gross lbs	Inner Pack	Master Pack	Cu. Ft.
SD3206J	6" x 6" x ¾", Square Plate	Each	19.31	12	48	0.51
SD3208J	8" x 8" x 1", Square Plate	Each	34.33	12	48	0.86
SD3210J	10" x 10" x 1½", Square Plate	Each	48.70	12	48	1.40
SD3212J	12" x 12" x 1¼", Square Plate	Each	41.60	6	24	1.39
SD3214J	14" x 14" x 1¼", Square Plate	Each	29.85	6	12	1.33
SD3216J	16" x 16" x 1¾", Square Plate	Each	41.62	6	12	1.56
SD3314J	96 oz, 13¾" x 9½" x 2¾", Tray	Each	53.95	6	24	1.97
SD3318J	58 oz, 17½" x ¾" x 1¼", Tray	Each	40.92	6	24	1.37

Black Pearl



Appetizer Platter • Party Plate •
Mug • All Purpose Bowl • Plates



Black Pearl

2024



Item	Description	U/M	Weight Gross lbs	Inner Pack	Master Pack	Cu. Ft.
RF1016B	16" Diameter, Round Plate, Black	Each	33.97	2	12	1.86
RF1018B	18" Diameter, Round Plate, Black	Each	27.49	2	8	1.58
RF1020B	20" Diameter, Round Plate, Black	Each	33.16	2	8	1.97
RF1016W	16" Diameter, Round Plate, White	Each	33.97	2	12	1.86
RF1018W	18" Diameter, Round Plate, White	Each	27.49	2	8	1.58
RF1020W	20" Diameter, Round Plate, White	Each	33.16	2	8	1.97



Item	Description	U/M	Weight Gross lbs	Inner Pack	Master Pack	Cu. Ft.
RF2024W	24" x 10", Platter, White	Each	32.01	2	12	1.94
RF2030W	30" x 12", Platter, White	Each	37.85	2	8	2.06
RF2024B	24" x 10", Platter, Black	Each	32.01	2	12	1.94
RF2030B	30" x 12", Platter, Black	Each	37.85	2	8	2.06

MELAMINE

Black Pearl



RF1016BW

RF1018BW

RF1020BW

Item	Description	U/M	Weight Gross lbs	Inner Pack	Master Pack	Cu. Ft.
RF1016BW	16" Diameter, Round Plate, Two Tone (Black and White)	Each	33.97	2	12	1.86
RF1018BW	18" Diameter, Round Plate, Two Tone (Black and White)	Each	27.49	2	8	1.58
RF1020BW	20" Diameter, Round Plate, Two Tone (Black and White)	Each	33.16	2	8	1.97



RF6016BW

7000BL

RF1006BW

RF1010BW

RF1065BW

RF1112B

Item	Description	U/M	Weight Gross lbs	Inner Pack	Master Pack	Cu. Ft.
7000BL	1 oz, 6 ³ / ₈ " x 1 ⁷ / ₈ ", Spoon, Black	Dozen	31.86	5	40	2.00
RF1006BW	8 ³ / ₈ " Diameter, Round Salad Plate, Two Tone (Black and White)	Each	28.66	12	48	0.95
RF1010BW	10 ¹ / ₂ " Diameter, Round Dinner Plate, Two Tone (Black and White)	Each	35.78	6	36	1.38
RF1065BW	6 ¹ / ₂ " Diameter, Round Saucer for RF9475, Two Tone (Black and White)	Each	31.59	12	96	1.20
RF6016BW	14 ¹ / ₂ " x 14 ¹ / ₂ ", 3-Section Round Appetizer Tray, Two Tone (Black and White)	Each	39.82	2	16	3.00
RF1112B	73 oz, 12" Diameter x 2" Deep, Salad Platter, Black	Each	39.46	6	24	2.19

****Soup Spoon is not NSF Certified.****



Item	Description	U/M	Weight Gross lbs	Inner Pack	Master Pack	Cu. Ft.
RF9475BW	23 oz, 4¾" Diameter x 3⅝" Height, Mug, Two Tone (Black and White)	Each	30.00	6	48	3.06
RF2024BW	24" x 10" Platter, Two Tone (Black and White)	Each	32.01	2	12	1.94
RF2030BW	30" x 12", Platter, Two Tone (Black and White)	Each	37.85	2	8	2.06
RF7010B	10½" Diameter, Round Party Plate with Thumb Hold, Black	Each	32.17	6	36	1.46
RF7010W	10½" Diameter, Round Party Plate with Thumb Hold, White	Each	32.17	6	36	1.46



Item	Description	U/M	Weight Gross lbs	Inner Pack	Master Pack	Cu. Ft.
RF5065BW	36 oz, 6½" Diameter, All Purpose Bowl, Two Tone (Black and White)	Each	34.28	6	48	2.17
RF5112BW	176 oz, 11¼" Diameter x 4⅝" Height, Serving Bowl, Two Tone (Black and White)	Each	28.11	3	12	2.47
RF2224BW	22" x 16½", Platter, Two Tone (Black and White)	Each	39.57	2	12	3.17

Gold Pearl

MELAMINE

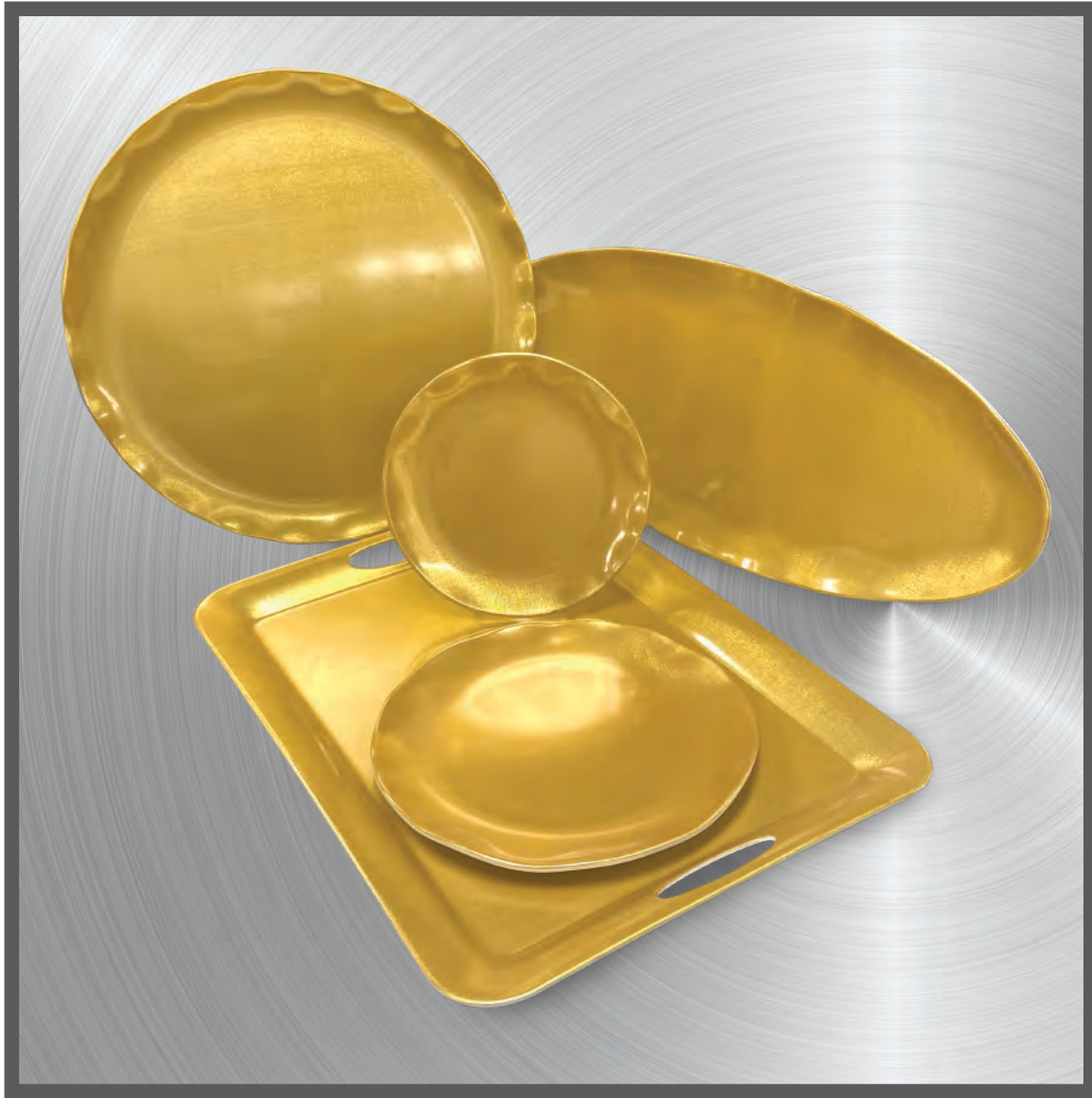

Platter • Rectangluar Tray •
Dinner Plates • 20" Plate





RF1016G



RF1018G

Item	Description	U/M	Weight Gross lbs	Inner Pack	Master Pack	Cu. Ft.
RF1016G	16" Diameter, Round Plate	Each	33.97	2	12	1.86
RF1018G	18" Diameter, Round Plate	Each	27.49	2	8	1.58



RF1006G



RF1010G

Item	Description	U/M	Weight Gross lbs	Inner Pack	Master Pack	Cu. Ft.
RF1006G	8½" Diameter, Round Salad Plate	Each	28.66	12	48	0.95
RF1010G	10½" Diameter, Round Dinner Plate	Each	35.78	6	36	1.38



Front & Back View

Decorated with real fabric texture on one side and white on the reverse side

Gold Pearl



RF1020G



RF2920G

Item	Description	U/M	Weight Gross lbs	Inner Pack	Master Pack	Cu. Ft.
RF1020G	20" Diameter, Round Plate	Each	33.16	2	8	1.97
RF2024G	24" x 10", Platter	Each	32.01	2	12	1.94



RF2030G



RF2024G

Item	Description	U/M	Weight Gross lbs	Inner Pack	Master Pack	Cu. Ft.
RF2030G	30" x 12", Platter	Each	37.85	2	8	2.06
RF2920G	19½" x 14½", Rectangle Tray	Each	25.88	3	12	1.42

* Decorated with real fabric texture on one side and white on the reverse side



Serving Boards



Rectangle Board • Board with Handle
- Faux Material -



Serving Boards

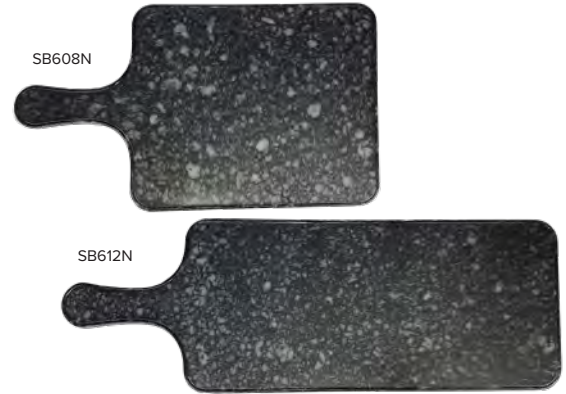
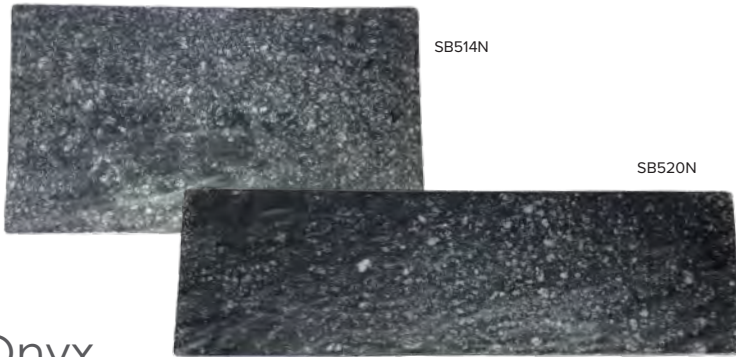

Onyx

Item	Description	U/M	Weight Gross lbs	Inner Pack	Master Pack	Cu. Ft.
SB514N	14¾" x 8¼" x ¾", Faux Marble	Each	27.50	6	12	0.62
SB520N	20¾" x 6¼" x ¾", Faux Marble	Each	28.50	6	12	0.69
SB608N	8⅞" x 7½" with 4⅞" Handle, Faux Marble	Each	21.34	6	24	1.03
SB612N	12⅞" x 5⅞" with 4⅞" Handle, Faux Marble	Each	23.69	6	24	1.08



Sequoia

Item	Description	U/M	Weight Gross lbs	Inner Pack	Master Pack	Cu. Ft.
SB514S	14¾" x 8¼" x ¾", Faux Wood	Each	27.50	6	12	0.62
SB520S	20¾" x 6¼" x ¾", Faux Wood	Each	28.50	6	12	0.69
SB608S	8⅞" x 7½" with 4⅞" Handle, Faux Wood	Each	21.34	6	24	1.03
SB612S	12⅞" x 5⅞" with 4⅞" Handle, Faux Wood	Each	23.69	6	24	1.08

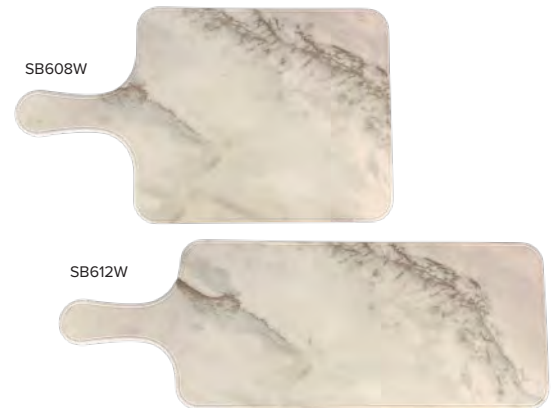

White Shadow

Item	Description	U/M	Weight Gross lbs	Inner Pack	Master Pack	Cu. Ft.
SB514W	14¾" x 8¼" x ¾", Faux Marble	Each	27.50	6	12	0.62
SB520W	20¾" x 6¼" x ¾", Faux Marble	Each	28.50	6	12	0.69
SB608W	8⅞" x 7½" with 4⅞" Handle, Faux Marble	Each	21.34	6	24	1.03
SB612W	12⅞" x 5⅞" with 4⅞" Handle, Faux Marble	Each	23.69	6	24	1.08

Passion Pearl



Compartment Tray • Square
Bowl • Round Square Bowls •
Square Plate



Passion Pearl



PS3008V



PS3010V



PS3014V

Item	Description	U/M	Weight Gross lbs	Inner Pack	Master Pack	Cu. Ft.
PS3008V	8¼" x 8¼", Round Square Plate	Each	27.12	12	48	0.97
PS3010V	11" x 11", Round Square Plate	Each	44.75	12	48	1.75
PS3014V	14" x 14", Round Square Plate	Each	54.89	6	24	1.58



PS3208V



PS3211V



PS3214V



PS5103V



PS5104V



PS1515V

Item	Description	U/M	Weight Gross lbs	Inner Pack	Master Pack	Cu. Ft.
PS3208V	8¼" x 8¼" x ¾", Square Plate	Each	45.86	12	72	1.28
PS3211V	10¼" x 10¼" x 1", Square Plate	Each	44.31	12	48	1.50
PS3214V	13¾" x 13¾" x 1½", Square Plate	Each	61.73	6	36	2.42
PS5103V	28 oz, 15" x 6¼" x 1¾", Rectangular 3-Section Tray	Each	38.58	6	36	1.29
PS5104V	60 oz, 13½" x 13½" x 1¾", Square 4-Section Tray	Each	49.38	6	36	2.03
PS1515V	15" x 15" x 1¾", Chip And Dip Platter	Each	27.12	6	12	1.80



PS3103V



PS3105V



PS3106V



PS3110V



PS3111V

Item	Description	U/M	Weight Gross lbs	Inner Pack	Master Pack	Cu. Ft.
PS3103V	5 oz, 3½" x 3½" x 1½", Round Square Bowl	Each	11.90	12	72	0.55
PS3105V	14 oz, 4¾" x 4¾" x 2½", Round Square Bowl	Each	48.72	12	144	2.20
PS3106V	20 oz, 5½" x 5½" x 2¾", Round Square Bowl	Each	42.77	12	72	1.59
PS3110V	96 oz, 11" Diameter x 3 ½" Deep, Bowl	Each	35.27	4	16	1.88
PS3111V	128 oz, 11" x 11" x 3½", Round Square Bowl	Each	51.81	6	24	2.74



PS5004V



PS5005V



PS5006V



PS5008V



PS5010V



PS9475V



PS3204V



PS6013V

Item	Description	U/M	Weight Gross lbs	Inner Pack	Master Pack	Cu. Ft.
PS5004V	8 oz, 4" x 4" x 2", Square Bowl	Each	22.99	12	144	0.70
PS5005V	11 oz, 4¾" x 4¾" x 2", Square Bowl	Each	32.63	12	144	1.10
PS5006V	23 oz, 6" x 6" x 2½", Square Bowl	Each	48.50	12	144	1.85
PS5008V	52 oz, 8" x 8" x 2½", Square Bowl	Each	33.26	12	48	1.11
PS5010V	80 oz, 10" x 10" x ½", Square Bowl	Each	41.16	12	36	1.36
PS9475V	23 oz, 4¾" Diameter x 3⅝" Height, Mug	Each	29.98	6	48	3.09
PS3204V	4" x 4", Square Plate	Each	33.64	12	216	0.89
PS6013V	70 oz, 13" Diameter x 4⅞" Deep, Salad Bowl	Each	35.05	4	16	2.62

Passion Red

MELAMINE



Square Bowl • Round Square
Plate • Square Plates • Mug





PS3008RD



PS3010RD



PS3014RD

Item	Description	U/M	Weight Gross lbs	Inner Pack	Master Pack	Cu. Ft.
PS3008RD	8¼" x 8¼", Round Square Plate	Each	27.12	12	48	0.97
PS3010RD	11" x 11", Round Square Plate	Each	44.75	12	48	1.75
PS3014RD	14" x 14", Round Square Plate	Each	54.89	6	24	1.58



PS3208RD



PS3211RD



PS3214RD

Item	Description	U/M	Weight Gross lbs	Inner Pack	Master Pack	Cu. Ft.
PS3208RD	8¼" x 8¼" x 7⁄8", Square Plate	Each	45.86	12	72	1.28
PS3211RD	10¼" x 10¼" x 1", Square Plate	Each	44.31	12	48	1.50
PS3214RD	13¾" x 13¾" x 1½", Square Plate	Each	61.73	6	36	2.42
PS5103RD	28 oz, 15" x 6¼" x 1⅜", Rectangular 3-Section Tray	Each	38.58	6	36	1.29
PS5104RD	60 oz, 13½" x 1½" x 1⅜", Square 4-Section Tray	Each	49.38	6	36	2.03
PS1515RD	15" x 15" x 1¾", Chip And Dip Platter	Each	27.12	6	12	1.80



PS5103RD



PS5104RD



PS1515RD

Passion Red

MELAMINE



PS3103RD



PS3105RD



PS3106RD



PS3110RD



PS3111RD

Item	Description	U/M	Weight Gross lbs	Inner Pack	Master Pack	Cu. Ft.
PS3103RD	5 oz, 3½" x 3½" x 1½", Round Square Bowl	Each	11.90	12	72	0.55
PS3105RD	14 oz, 4¾" x 4¾" x 2½", Round Square Bowl	Each	48.72	12	144	2.20
PS3106RD	20 oz, 5½" x 5½" x 2¾", Round Square Bowl	Each	42.77	12	72	1.59
PS3110RD	96 oz, 11" Diameter x 3½" Deep, Bowl	Each	35.27	4	16	1.88
PS3111RD	128 oz, 11" x 11" x 3½", Round Square Bowl	Each	51.81	6	24	2.74



PS5004RD



PS5005RD



PS5006RD



PS5008RD



PS5010RD



PS9475RD



PS3204RD



PS6013RD

Item	Description	U/M	Weight Gross lbs	Inner Pack	Master Pack	Cu. Ft.
PS5004RD	8 oz, 4" x 4" x 2", Square Bowl	Each	22.99	12	144	0.70
PS5005RD	11 oz, 4¾" x 4¾" x 2", Square Bowl	Each	32.63	12	144	1.10
PS5006RD	23 oz, 6" x 6" x 2½", Square Bowl	Each	48.50	12	144	1.85
PS5008RD	52 oz, 8" x 8" x 2½", Square Bowl	Each	33.26	12	48	1.11
PS5010RD	80 oz, 10" x 10" x 2½", Square Bowl	Each	41.16	12	36	1.36
PS9475RD	23 oz, 4¾" Diameter x 3⅝" Height, Mug	Each	29.98	6	48	3.09
PS3204RD	4" x 4", Square Plate	Each	33.64	12	216	0.89
PS6013RD	70 oz, 13" Diameter x 4⅞" Deep, Salad Bowl	Each	35.05	4	16	2.62



Passion White



Round Square Plate • Square Plate • Square Bowl • Mug



Passion White



PS3008W



PS3010W



PS3014W

Item	Description	U/M	Weight Gross lbs	Inner Pack	Master Pack	Cu. Ft.
PS3008W	8¼" x 8¼", Round Square Plate	Each	27.12	12	48	0.97
PS3010W	11" x 11", Round Square Plate	Each	44.75	12	48	1.75
PS3014W	14" x 14", Round Square Plate	Each	54.89	6	24	1.58



PS3208W



PS3211W



PS3214W



PS5103W



PS5104W



PS1515W

Item	Description	U/M	Weight Gross lbs	Inner Pack	Master Pack	Cu. Ft.
PS3208W	8¼" x 8¼" x 7⁄8", Square Plate	Each	45.86	12	72	1.28
PS3211W	10¼" x 10¼" x 1", Square Plate	Each	44.31	12	48	1.50
PS3214W	13¾" x 13¾" x 1½", Square Plate	Each	61.73	6	36	2.42
PS5103W	28 oz, 15" x 6¼" x 1 3⁄8", Rectangular 3-Section Tray	Each	38.58	6	36	1.29
PS5104W	60 oz, 13½" x 13½" x 1 3⁄8", Square 4-Section Tray	Each	49.38	6	36	2.03
PS1515W	15" x 15" x 1¾", Chip And Dip Platter	Each	27.12	6	12	1.80



PS3103W



PS3105W



PS3106W



PS3110W



PS3111W

Item	Description	U/M	Weight Gross lbs	Inner Pack	Master Pack	Cu. Ft.
PS3103W	5 oz, 3½" x 3½" x 1½", Round Square Bowl	Each	11.90	12	72	0.55
PS3105W	14 oz, 4¾" x 4¾" x 2½", Round Square Bowl	Each	48.72	12	144	2.20
PS3106W	20 oz, 5½" x 5½" x 2¾", Round Square Bowl	Each	42.77	12	72	1.59
PS3110W	96 oz, 11" Diameter x 3½" Deep, Bowl	Each	35.27	4	16	1.88
PS3111W	128 oz, 11" x 11" x 3½", Round Square Bowl	Each	51.81	6	24	2.74



PS5004W



PS5005W



PS5006W



PS5008W



PS5010W



PS9475W



PS3204W



PS6013W

Item	Description	U/M	Weight Gross lbs	Inner Pack	Master Pack	Cu. Ft.
PS5004W	8 oz, 4" x 4" x 2", Square Bowl	Each	22.99	12	144	0.70
PS5005W	11 oz, 4¾" x 4¾" x 2", Square Bowl	Each	32.63	12	144	1.10
PS5006W	23 oz, 6" x 6" x 2½", Square Bowl	Each	48.50	12	144	1.85
PS5008W	52 oz, 8" x 8" x 2½", Square Bowl	Each	33.26	12	48	1.11
PS5010W	80 oz, 10" x 10" x 2½", Square Bowl	Each	41.16	12	36	1.36
PS9475W	23 oz, 4¾" Diameter x 3⅝" Height, Mug	Each	29.98	6	48	3.09
PS3204W	4" x 4", Square Plate	Each	33.64	12	216	0.89
PS6013W	70 oz, 13" Diameter x 4⅞" Deep, Salad Bowl	Each	35.05	4	16	2.62

Blue Dragon

MELAMINE



Plate • Deep Platter • Lid • Bowl
• Soup Spoon • Tea Cup



Blue Dragon

2024



Item	Description	U/M	Weight Gross lbs	Inner Pack	Master Pack	Cu. Ft.
1006DL	6" Diameter x ½" Height, Round Plate	Dozen	60.63	1	24	1.96
1007DL	6⅞" Diameter x ¾" Height, Round Plate	Dozen	46.03	1	16	1.69
1008DL	7⅞" Diameter x ⅝" Height, Round Plate	Dozen	55.12	1	12	1.86
1009DL	9⅞" Diameter x ¾" Height, Round Plate	Dozen	49.71	1	8	1.66
1010DL	10⅝" Diameter x ⅞" Height, Round Plate	Dozen	39.48	1	6	1.69
1012DL	11¾" Diameter x ⅞" Height, Round Plate	Dozen	44.25	1	4	1.62
1013DL	12⅝" Diameter x 1" Height, Round Plate	Dozen	43.21	0.50	3	1.77
1014DL	14⅞" Diameter x 1⅝" Height, Round Plate	Dozen	51.81	0.50	3	2.22
1016DL	15½" Diameter x 1¼" Height, Round Plate	Dozen	48.50	0.50	2	2.62
1015DL	14⅜" Diameter x 1¾" Height, Narrow Rim Round Plate	Dozen	48.50	0.50	2	3.21



Item	Description	U/M	Weight Gross lbs	Inner Pack	Master Pack	Cu.Ft
1106DL	3 oz, 6" Diameter x 1" Height, Soup Plate	Dozen	48.50	1	18	1.52
1107DL	5 oz, 7" Diameter x 1" Height, Soup Plate	Dozen	52.91	1	16	1.89
1108DL	7 oz, 7⅞" Diameter x 1" Height, Soup Plate	Dozen	50.04	1	12	1.92
1109DL	10 oz, 9¼" Diameter x 1¼" Height, Soup Plate	Dozen	68.12	1	10	2.49
1110DL	12 oz, 10⅝" Diameter x 1¼" Height, Soup Plate	Dozen	65.70	1	8	2.41

MELAMINE

105

Blue Dragon

MELAMINE



2109DL



2110DL



2112DL



2113DL



2114DL

Item	Description	U/M	Weight Gross lbs	Inner Pack	Master Pack	Cu. Ft.
2109DL	7 oz, 9" x 6 ³ / ₄ " x 1 ¹ / ₈ ", Deep Platter	Dozen	53.79	1	10	1.81
2110DL	9 oz, 10" x 7 ¹ / ₂ " x 1 ¹ / ₈ ", Deep Platter	Dozen	51.15	1	8	1.76
2112DL	16 oz, 12" x 9" x 1 ⁵ / ₈ ", Deep Platter	Dozen	58.30	1	6	2.49
2113DL	24 oz, 13" x 9 ³ / ₄ " x 1 ⁵ / ₈ ", Deep Platter	Dozen	49.60	1	4	1.97
2114DL	28 oz, 14 ¹ / ₈ " x 10 ⁵ / ₈ " x 1 ³ / ₄ ", Deep Platter	Dozen	53.57	1	4	2.37



2008DL



2009DL



2010DL



2012DL



2014DL



2016DL

Item	Description	U/M	Weight Gross lbs	Inner Pack	Master Pack	Cu. Ft.
2008DL	8" x 6" x 5 ⁵ / ₈ ", Platter	Dozen	54.01	1	16	2.65
2009DL	9" x 6 ⁵ / ₈ " x 3 ³ / ₄ ", Platter	Dozen	41.23	1	10	1.84
2010DL	9 ⁷ / ₈ " x 7 ¹ / ₄ " x 3 ³ / ₄ ", Platter	Dozen	50.86	1	8	1.90
2012DL	12" x 8 ⁵ / ₈ " x 7 ⁷ / ₈ ", Platter	Dozen	48.50	1	6	2.06
2014DL	14" x 10" x 1 ¹ / ₈ ", Platter	Dozen	34.94	0.50	3	2.18
2016DL	16" x 11 ⁵ / ₈ " x 1 ¹ / ₄ ", Platter	Dozen	51.81	0.50	3	2.13



5060DL



5065DL



5070DL



5075DL



5085DL



5095DL

Item	Description	U/M	Weight Gross lbs	Inner Pack	Master Pack	Cu. Ft.
5060DL	22 oz, 6 ⁷ / ₈ " Diameter x 2 ¹ / ₄ " Height, Rimless Bowl	Dozen	37.92	1	8	2.07
5065DL	32 oz, 7 ¹ / ₂ " Diameter x 2 ¹ / ₂ " Height, Rimless Bowl	Dozen	43.98	1	8	2.59
5070DL	36 oz, 8" Diameter x 2 ⁵ / ₈ " Height, Rimless Bowl	Dozen	41.45	1	6	2.10
5075DL	52 oz, 8 ³ / ₄ " Diameter x 2 ⁷ / ₈ " Height, Rimless Bowl	Dozen	47.18	1	6	2.43
5085DL	70 oz, 9 ³ / ₄ " Diameter x 3 ¹ / ₄ " Height, Rimless Bowl	Dozen	48.06	0.50	4	3.24
5095DL	96 oz, 11" Diameter x 3 ³ / ₄ " Height, Rimless Bowl	Dozen	51.15	0.50	3	3.66



5206DL



5207DL



5208DL



5265DL



5275DL



5285DL

Item	Description	U/M	Weight Gross lbs	Inner Pack	Master Pack	Cu. Ft.
5206DL	25 oz, 5 ⁷ / ₈ " Diameter x 2 ⁷ / ₈ " Height, Rice Bowl	Dozen	26.46	1	6	1.35
5207DL	39 oz, 7" Diameter x 3 ¹ / ₄ " Height, Rice Bowl	Dozen	37.15	1	6	2.11
5208DL	56 oz, 8" Diameter x 3 ¹ / ₂ " Height, Rice Bowl	Dozen	41.29	1	6	2.50
5265DL	25 oz, 6 ¹ / ₄ " Diameter x 2 ³ / ₄ " Height, Scalloped Bowl	Dozen	39.68	1	8	1.92
5275DL	34 oz, 7 ¹ / ₄ " Diameter x 3" Height, Scalloped Bowl	Dozen	40.79	1	6	1.82
5285DL	53 oz, 8 ¹ / ₄ " Diameter x 3 ¹ / ₂ " Height, Scalloped Bowl	Dozen	60.63	0.50	6	3.60

Blue Dragon

MELAMINE



5106DL



5107DL



5108DL



5306DL



5307DL



5308DL



5309DL

Item	Description	U/M	Weight Gross lbs	Inner Pack	Master Pack	Cu.Ft
5106DL	15 oz, 6" Diameter x 2" Height, Deep Bowl	Dozen	39.24	1	12	1.76
5107DL	24 oz, 7" Diameter x 2¼" Height, Deep Bowl	Dozen	39.68	1	8	1.46
5108DL	34 oz, 8" Diameter x 2½" Height, Deep Bowl	Dozen	50.71	1	8	2.47
5306DL	21 oz, 6" Diameter x 2½" Height, Swirl Bowl	Dozen	29.10	1	6	1.29
5307DL	32 oz, 6⅞" Diameter x 2¾" Height, Swirl Bowl	Dozen	37.48	1	6	1.58
5308DL	48 oz, 8" Diameter x 3½" Height, Swirl Bowl	Dozen	51.15	0.50	6	2.94
5309DL	72 oz, 9" Diameter x 3½" Height, Swirl Bowl	Dozen	37.92	0.50	3	2.16



3201DL (Bowl)
(Lid & Bowl are sold separately)



3201CDL (LID)



8010DL



8011DL

Item	Description	U/M	Weight Gross lbs	Inner Pack	Master Pack	Cu.Ft
3201DL	20 oz, 5¾" Diameter x 3" Height, Noodle Bowl (Lid Sold Separately)	Dozen	29.76	1	6	1.19
3201CDL	5 ¼" Diameter, Lid only for 3201DL	Dozen	14.33	1	6	0.97
8010DL	75 oz, 10" Diameter x 3½" Height, Serving Bowl with Lid	Each	23.15	1	12	3.15
8011DL	80 oz, 11" Diameter x 3¾" Height, Serving Bowl with Lid	Each	29.76	1	12	3.60



3004DL



3006DL



3008DL



9152DL

3008TW • Rice Bowl
Enlarged to show detail



Item	Description	U/M	Weight Gross lbs	Inner Pack	Master Pack	Cu.Ft
3004DL	12 oz, 4 $\frac{1}{8}$ " Diameter x 2 $\frac{3}{8}$ " Height, Rice Bowl	Dozen	54.54	1	18	2.63
3006DL	9 oz, 4 $\frac{3}{8}$ " Diameter x 2 $\frac{1}{8}$ " Height, Rice Bowl	Dozen	52.36	1	24	2.60
3008DL	6 oz, 3 $\frac{3}{4}$ " Diameter x 2" Height, Rice Bowl	Dozen	42.99	2	24	1.79
9152DL	5 oz, 3 $\frac{1}{8}$ " Diameter x 2 $\frac{1}{8}$ " Height, Tea Cup	Dozen	54.67	1	30	2.94



7003DL



7005DL

7005DL • Rice Ladle
Enlarged to show detail



Item	Description	U/M	Weight Gross lbs	Inner Pack	Master Pack	Cu.Ft
7003DL	$\frac{3}{4}$ oz, 5 $\frac{3}{4}$ " x 1 $\frac{3}{4}$ ", Won Ton Soup Spoon	Dozen	52.58	5	100	2.26
7005DL	1 $\frac{1}{2}$ oz, 8 $\frac{1}{4}$ " x 2 $\frac{3}{4}$ ", Rice Ladle	Dozen	48.50	2	30	2.38



1003DL



102.8DL



1101DL



1004DL



1102DL

1101DL • Sauce Dish
Enlarged to show detail



Item	Description	U/M	Weight Gross lbs	Inner Pack	Master Pack	Cu.Ft
1003DL	3 oz, 3 $\frac{3}{8}$ " Diameter x $\frac{3}{4}$ " Height, Sauce Dish	Dozen	54.01	5	50	2.04
102.8DL	2 oz, 3 $\frac{1}{2}$ " Diameter x $\frac{3}{8}$ " Height, Sauce Dish	Dozen	64.77	5	80	1.89
1101DL	1 oz, 2 $\frac{3}{4}$ " Diameter x $\frac{5}{8}$ " Height, Sauce Dish	Dozen	42.97	5	80	1.22
1004DL	4 oz, 4 $\frac{1}{2}$ " Diameter x $\frac{3}{4}$ " Height, Round Plate	Dozen	26.01	1	12	0.90
1102DL	2 oz, 3 $\frac{3}{8}$ " x 2 $\frac{3}{4}$ " x $\frac{1}{2}$ ", Twin Sauce Dish	Dozen	41.89	2	40	1.65

****Rice Ladle and Soup Spoon are not NSF Certified.****

Imperial

MELAMINE



Plate • Platter Soup Plate • Rice
Bowl • Sauce Dish • Soup Spoon





1006TW

1007TW

1008TW

1009TW

1010TW

1012TW



1013TW

1014TW

1016TW

1015TW

Item	Description	U/M	Weight Gross lbs	Inner Pack	Master Pack	Cu. Ft.
1006TW	6" Diameter x 1/2" Height, Round Plate	Dozen	60.63	1	24	1.96
1007TW	6 7/8" Diameter x 3/4" Height, Round Plate	Dozen	45.98	1	16	1.69
1008TW	7 7/8" Diameter x 5/8" Height, Round Plate	Dozen	55.12	1	12	1.86
1009TW	9 1/8" Diameter x 3/4" Height, Round Plate	Dozen	49.71	1	8	1.66
1010TW	10 3/8" Diameter x 7/8" Height, Round Plate	Dozen	39.48	1	6	1.69
1012TW	11 3/4" Diameter x 7/8" Height, Round Plate	Dozen	44.25	1	4	1.62
1013TW	12 5/8" Diameter x 1" Height, Round Plate	Dozen	43.21	0.50	3	1.77
1014TW	14 1/8" Diameter x 1 1/8" Height, Round Plate	Dozen	51.81	0.50	3	2.22
1016TW	15 1/2" Diameter x 1 1/4" Height, Round Plate	Dozen	48.50	0.50	2	2.62
1015TW	14 3/8" Diameter x 1 3/4" Height, Narrow Rim Round Plate	Dozen	48.50	0.50	2	3.21



1106TW

1107TW

1108TW

1109TW

1110TW

Item	Description	U/M	Weight Gross lbs	Inner Pack	Master Pack	Cu. Ft.
1106TW	3 oz, 6" Diameter x 1" Height, Soup Plate	Dozen	48.50	1	18	1.52
1107TW	5 oz, 7" Diameter x 1" Height, Soup Plate	Dozen	52.91	1	16	1.89
1108TW	7 oz, 7 7/8" Diameter x 1" Height, Soup Plate	Dozen	50.04	1	12	1.92
1109TW	10 oz, 9 1/4" Diameter x 1 1/4" Height, Soup Plate	Dozen	68.12	1	10	2.49
1110TW	12 oz, 10 3/8" Diameter x 1 1/4" Height, Soup Plate	Dozen	65.70	1	8	2.41

Imperial

MELAMINE



2109TW



2110TW



2112TW



2113TW



2114TW

Item	Description	U/M	Weight Gross lbs	Inner Pack	Master Pack	Cu. Ft.
2109TW	7 oz, 9" x 6 $\frac{3}{4}$ " x 1 $\frac{1}{8}$ ", Deep Platter	Dozen	53.79	1	10	1.81
2110TW	9 oz, 10" x 7 $\frac{1}{2}$ " x 1 $\frac{1}{8}$ ", Deep Platter	Dozen	51.15	1	8	1.76
2112TW	16 oz, 12" x 9" x 1 $\frac{5}{8}$ ", Deep Platter	Dozen	58.30	1	6	2.49
2113TW	24 oz, 13" x 9 $\frac{3}{4}$ " x 1 $\frac{5}{8}$ ", Deep Platter	Dozen	49.60	1	4	1.97
2114TW	28 oz, 14 $\frac{1}{8}$ " x 10 $\frac{5}{8}$ " x 1 $\frac{3}{4}$ ", Deep Platter	Dozen	53.57	1	4	2.37



2008TW



2009TW



2010TW



2012TW



2014TW



2016TW

Item	Description	U/M	Weight Gross lbs	Inner Pack	Master Pack	Cu. Ft.
2008TW	8" x 6" x $\frac{5}{8}$ ", Platter	Dozen	54.01	1	16	2.65
2009TW	9" x 6 $\frac{5}{8}$ " x $\frac{3}{4}$ ", Platter	Dozen	41.23	1	10	1.84
2010TW	9 $\frac{7}{8}$ " x 7 $\frac{1}{4}$ " x $\frac{3}{4}$ ", Platter	Dozen	50.86	1	8	1.90
2012TW	12" x 8 $\frac{5}{8}$ " x $\frac{7}{8}$ ", Platter	Dozen	48.50	1	6	2.06
2014TW	14" x 10" x 1 $\frac{1}{8}$ ", Platter	Dozen	34.94	0.50	3	2.18
2016TW	16" x 11 $\frac{5}{8}$ " x 1 $\frac{1}{4}$ ", Platter	Dozen	51.81	0.50	3	2.13



5265TW



5275TW



5285TW



5206TW



5207TW



5208TW

Item	Description	U/M	Weight Gross lbs	Inner Pack	Master Pack	Cu. Ft.
5265TW	25 oz, 6¼" Diameter x 2¾" Height, Scalloped Bowl	Dozen	39.68	1	8	1.92
5275TW	34 oz, 7¼" Diameter x 3" Height, Scalloped Bowl	Dozen	40.79	1	6	1.82
5285TW	53 oz, 8¼" Diameter x 3½" Height, Scalloped Bowl	Dozen	60.63	0.50	6	3.60
5206TW	25 oz, 5⅞" Diameter x 2⅞" Height, Rice Bowl	Dozen	26.46	1	6	1.35
5207TW	39 oz, 7" Diameter x 3¼" Height, Rice Bowl	Dozen	37.15	1	6	2.11
5208TW	56 oz, 8" Diameter x 3½" Height, Rice Bowl	Dozen	41.29	1	6	2.50



5306TW



5307TW



5308TW



5309TW



5106TW



5107TW



5108TW

Item	Description	U/M	Weight Gross lbs	Inner Pack	Master Pack	Cu. Ft.
5306TW	21 oz, 6" Diameter x 2½" Height, Swirl Bowl	Dozen	29.10	1	6	1.29
5307TW	32 oz, 6⅞" Diameter x 2¾" Height, Swirl Bowl	Dozen	37.48	1	6	1.58
5308TW	48 oz, 8" Diameter x 3⅞" Height, Swirl Bowl	Dozen	51.15	0.50	6	2.94
5309TW	72 oz, 9" Diameter x 3½" Height, Swirl Bowl	Dozen	37.92	0.50	3	2.16
5106TW	15 oz, 6" Diameter x 2" Height, Bowl	Dozen	39.24	1	12	1.76
5107TW	24 oz, 7" Diameter x 2¼" Height, Bowl	Dozen	39.68	1	8	1.46
5108TW	34 oz, 8" Diameter x 2½" Height, Bowl	Dozen	50.71	1	8	2.47

Imperial



3008TW • Rice Bowl
Enlarged to show detail



3004TW



3006TW



3008TW

Item	Description	U/M	Weight Gross lbs	Inner Pack	Master Pack	Cu. Ft.
3004TW	12 oz, 4 $\frac{7}{8}$ " Diameter x 2 $\frac{3}{8}$ " Height, Rice Bowl	Dozen	54.54	1	18	2.63
3006TW	9 oz, 4 $\frac{3}{8}$ " Diameter x 2 $\frac{1}{8}$ " Height, Rice Bowl	Dozen	52.36	1	24	2.60
3008TW	6 oz, 3 $\frac{3}{4}$ " Diameter x 2" Height, Rice Bowl	Dozen	42.99	2	24	1.79



7005R • Rice Ladle
Enlarged to show detail



7100TW



7200TW



7003W

Item	Description	U/M	Weight Gross lbs	Inner Pack	Master Pack	Cu. Ft.
7003W	$\frac{3}{4}$ oz, 5 $\frac{3}{4}$ " x 1 $\frac{3}{4}$ ", Won Ton Soup Spoon	Dozen	52.58	5	100	2.26
7100TW	1 oz, 6 $\frac{1}{4}$ " x 1 $\frac{3}{4}$ ", Soup Spoon	Dozen	45.48	5	60	2.21
7200TW	0.6 oz, 6 $\frac{3}{8}$ " x 1 $\frac{3}{4}$ ", Soup Spoon	Dozen	37.93	5	60	1.74



1002TW • Twin Sauce Dish
Enlarged to show detail



1003TW



102.8TW



1101TW



1004TW



1102TW

Item	Description	U/M	Weight Gross lbs	Inner Pack	Master Pack	Cu. Ft.
1003TW	3 oz, 3 $\frac{7}{8}$ " Diameter x $\frac{3}{4}$ " Height, Sauce Dish	Dozen	54.01	5	50	2.04
102.8TW	2 oz, 3 $\frac{1}{2}$ " Diameter x $\frac{3}{8}$ " Height, Sauce Dish	Dozen	64.77	5	80	1.89
1101TW	1 oz, 2 $\frac{3}{4}$ " Diameter x $\frac{5}{8}$ " Height, Sauce Dish	Dozen	42.97	5	80	1.22
1004TW	4 oz, 4 $\frac{1}{2}$ " Diameter x $\frac{3}{4}$ " Height, Round Plate	Dozen	26.01	1	12	0.90
1102TW	2 oz, 3 $\frac{3}{8}$ " x 2 $\frac{3}{4}$ " x $\frac{1}{2}$ ", Twin Sauce Dish	Dozen	41.89	2	40	1.65

****Soup Spoons are not NSF Certified.****



Longevity



Platter • Soup Plate • Soup Spoon
• Rice Bowl • Twin Sauce Dish



Longevity

MELAMINE



1006TR

1007TR

1008TR

1009TR

1010TR

1012TR



1013TR

1014TR

1016TR

1015TR

Item	Description	U/M	Weight Gross lbs	Inner Pack	Master Pack	Cu. Ft.
1006TR	6" Diameter x 1/2" Height, Round Plate	Dozen	60.63	1	24	1.96
1007TR	6 7/8" Diameter x 3/4" Height, Round Plate	Dozen	46.03	1	16	1.69
1008TR	7 7/8" Diameter x 5/8" Height, Round Plate	Dozen	55.12	1	12	1.86
1009TR	9 1/8" Diameter x 3/4" Height, Round Plate	Dozen	49.71	1	8	1.66
1010TR	10 3/8" Diameter x 7/8" Height, Round Plate	Dozen	39.48	1	6	1.69
1012TR	11 3/4" Diameter x 7/8" Height, Round Plate	Dozen	44.25	1	4	1.62
1013TR	12 5/8" Diameter x 1" Height, Round Plate	Dozen	43.21	0.50	3	1.77
1014TR	14 1/8" Diameter x 1 1/8" Height, Round Plate	Dozen	51.81	0.50	3	2.22
1016TR	15 1/2" Diameter x 1 1/4" Height, Round Plate	Dozen	48.50	0.50	2	2.62
1015TR	14 3/8" Diameter x 1 3/4" Height, Narrow Round Plate	Dozen	48.50	0.50	2	3.21



1106TR

1107TR

1108TR

1109TR

1110TR

Item	Description	U/M	Weight Gross lbs	Inner Pack	Master Pack	Cu. Ft.
1106TR	3 oz, 6" Diameter x 1" Height, Soup Plate	Dozen	48.50	1	18	1.52
1107TR	5 oz, 7" Diameter x 1" Height, Soup Plate	Dozen	52.91	1	16	1.89
1108TR	7 oz, 7 7/8" Diameter x 1" Height, Soup Plate	Dozen	50.04	1	12	1.92
1109TR	10 oz, 9 1/4" Diameter x 1 1/4" Height, Soup Plate	Dozen	68.12	1	10	2.49
1110TR	12 oz, 10 3/8" Diameter x 1 1/4" Height, Soup Plate	Dozen	65.70	1	8	2.41



2109TR



2110TR



2112TR



2113TR



2114TR

Item	Description	U/M	Weight Gross lbs	Inner Pack	Master Pack	Cu. Ft.
2109TR	7 oz, 9" x 6 ³ / ₄ " x 1 ¹ / ₈ ", Deep Platter	Dozen	53.79	1	10	1.81
2110TR	9 oz, 10" x 7 ¹ / ₂ " x 1 ¹ / ₈ ", Deep Platter	Dozen	51.15	1	8	1.76
2112TR	16 oz, 12" x 9" x 1 ⁵ / ₈ ", Deep Platter	Dozen	58.30	1	6	2.49
2113TR	24 oz, 13" x 9 ³ / ₄ " x 1 ⁵ / ₈ ", Deep Platter	Dozen	49.60	1	4	1.97
2114TR	28 oz, 14 ¹ / ₈ " x 10 ⁵ / ₈ " x 1 ³ / ₄ ", Deep Platter	Dozen	53.57	1	4	2.37



2008TR



2009TR



21010TR



2012TR



2014TR



2016TR

Item	Description	U/M	Weight Gross lbs	Inner Pack	Master Pack	Cu. Ft.
2008TR	8" x 6" x ⁵ / ₈ ", Platter	Dozen	54.01	1	16	2.65
2009TR	9" x 6 ⁵ / ₈ " x ³ / ₄ ", Platter	Dozen	41.23	1	10	1.84
21010TR	9 ⁷ / ₈ " x 7 ¹ / ₄ " x ³ / ₄ ", Platter	Dozen	50.86	1	8	1.90
2012TR	12" x 8 ⁵ / ₈ " x ⁷ / ₈ ", Platter	Dozen	48.50	1	6	2.06
2014TR	14" x 10" x 1 ¹ / ₈ ", Platter	Dozen	34.94	0.50	3	2.18
2016TR	16" x 11 ⁵ / ₈ " x 1 ¹ / ₄ ", Platter	Dozen	51.81	0.50	3	2.13

Longevity

MELAMINE



5060TR



5065TR



5070TR



5075TR



5085TR



5095TR

Item	Description	U/M	Weight Gross lbs	Inner Pack	Master Pack	Cu. Ft.
5060TR	22 oz, 6 $\frac{7}{8}$ " Diameter x 2 $\frac{1}{4}$ " Height, Rimless Bowl	Dozen	37.92	1	8	2.07
5065TR	32 oz, 7 $\frac{1}{2}$ " Diameter x 2 $\frac{1}{2}$ " Height, Rimless Bowl	Dozen	43.98	1	8	2.59
5070TR	36 oz, 8" Diameter x 2 $\frac{5}{8}$ " Height, Rimless Bowl	Dozen	41.45	1	6	2.10
5075TR	52 oz, 8 $\frac{3}{4}$ " Diameter x 2 $\frac{7}{8}$ " Height, Rimless Bowl	Dozen	47.18	1	6	2.43
5085TR	70 oz, 9 $\frac{3}{4}$ " Diameter x 3 $\frac{1}{4}$ " Height, Rimless Bowl	Dozen	48.06	0.50	4	3.24
5095TR	96 oz, 11" Diameter x 3 $\frac{3}{4}$ " Height, Rimless Bowl	Dozen	51.15	0.50	3	3.66



5206TR



5207TR



5208TR



5265TR



5275TR



5285TR

Item	Description	U/M	Weight Gross lbs	Inner Pack	Master Pack	Cu. Ft.
5206TR	25 oz, 5 $\frac{7}{8}$ " Diameter x 2 $\frac{7}{8}$ " Height, Rice Bowl	Dozen	26.46	1	6	1.35
5207TR	39 oz, 7" Diameter x 3 $\frac{1}{4}$ " Height, Rice Bowl	Dozen	37.15	1	6	2.11
5208TR	56 oz, 8" Diameter x 3 $\frac{1}{2}$ " Height, Rice Bowl	Dozen	41.29	1	6	2.50
5265TR	25 oz, 6 $\frac{1}{4}$ " Diameter x 2 $\frac{3}{4}$ " Height, Scalloped Bowl	Dozen	39.68	1	8	1.92
5275TR	34 oz, 7 $\frac{1}{4}$ " Diameter x 3" Height, Scalloped Bowl	Dozen	40.79	1	6	1.82
5285TR	53 oz, 8 $\frac{1}{4}$ " Diameter x 3 $\frac{1}{2}$ " Height, Scalloped Bowl	Dozen	60.63	0.50	6	3.60



5106TR



5107TR



5108TR



5306TR



5307TR



5308TR



5309TR

Item	Description	U/M	Weight Gross lbs	Inner Pack	Master Pack	Cu. Ft.
5106TR	15 oz, 6" Diameter x 2" Height, Deep Bowl	Dozen	39.24	1	12	1.76
5107TR	24 oz, 7" Diameter x 2¼" Height, Deep Bowl	Dozen	39.68	1	8	1.46
5108TR	34 oz, 8" Diameter x 2½" Height, Deep Bowl	Dozen	50.71	1	8	2.47
5306TR	21 oz, 6" Diameter x 2½" Height, Swirl Bowl	Dozen	29.10	1	6	1.29
5307TR	32 oz, 6¾" Diameter x 2¾" Height, Swirl Bowl	Dozen	37.48	1	6	1.58
5308TR	48 oz, 8" Diameter x 3⅛" Height, Swirl Bowl	Dozen	51.15	0.50	6	2.94
5309TR	72 oz, 9" Diameter x 3½" Height, Swirl Bowl	Dozen	37.92	0.50	3	2.16



8010TR



8011TR



3201TR (Bowl)
(Lid & Bowl are sold separately)



3201CTR (Lid)

Item	Description	U/M	Weight Gross lbs	Inner Pack	Master Pack	Cu. Ft.
8010TR	75 oz, 10" Diameter x 3⅞" Height, Serving Bowl with Lid	Each	23.15	1	12	3.15
8011TR	80 oz, 11" Diameter x 3¼" Height, Serving Bowl with Lid	Each	29.76	1	12	3.60
3201TR	20 oz, 5¾" Diameter x 3" Height, Noodle Bowl (Lid Sold Separately)	Dozen	29.76	1	6	1.19
3201CTR	5¼" Diameter, Lid only for 3201TR	Dozen	14.33	1	6	0.97

Longevity



9156TR • Cup
Enlarged to show detail



Item	Description	U/M	Weight Gross lbs	Inner Pack	Master Pack	Cu. Ft.
3004TR	12 oz, 4 $\frac{3}{8}$ " Diameter x 2 $\frac{3}{8}$ " Height, Rice Bowl	Dozen	54.54	1	18	2.63
3006TR	9 oz, 4 $\frac{3}{8}$ " Diameter x 2 $\frac{1}{8}$ " Height, Rice Bowl	Dozen	52.36	1	24	2.60
3008TR	6 oz, 3 $\frac{3}{4}$ " Diameter x 2" Height, Rice Bowl	Dozen	42.99	2	24	1.79
5008TR	35 oz, 8" Diameter x 2 $\frac{5}{8}$ " Height, Special Deep Bowl	Dozen	41.89	1	6	2.27
9152TR	5 oz, 3 $\frac{3}{8}$ " Diameter x 2 $\frac{1}{8}$ " Height, Tea Cup	Dozen	54.67	1	30	2.94
9156TR	1 $\frac{1}{2}$ oz, 2" Diameter x 2 $\frac{1}{4}$ " Height, Cup	Dozen	49.60	5	120	2.84



7005R • Rice Ladle
Enlarged to show detail



Item	Description	U/M	Weight Gross lbs	Inner Pack	Master Pack	Cu. Ft.
7002TR	$\frac{1}{2}$ oz, 4 $\frac{7}{8}$ " x 1 $\frac{5}{8}$ ", Soup Spoon	Dozen	60.63	5	100	1.99
7003R	$\frac{3}{4}$ oz, 5 $\frac{3}{4}$ " x 1 $\frac{3}{4}$ ", Won Ton Soup Spoon	Dozen	52.58	5	100	2.26
7004TR	$\frac{3}{4}$ oz, 5 $\frac{1}{4}$ " x 1 $\frac{3}{4}$ ", Spoon	Dozen	52.66	5	100	2.26
7005R	1 $\frac{1}{2}$ oz, 8 $\frac{1}{4}$ " x 2 $\frac{3}{4}$ ", Rice Ladle	Dozen	48.50	2	30	2.38
7100TR	1 oz, 6 $\frac{1}{4}$ " x 1 $\frac{3}{4}$ " x 2", Soup Spoon	Dozen	45.48	5	60	2.21



1004TR • Round Plate
Enlarged to show detail



Item	Description	U/M	Weight Gross lbs	Inner Pack	Master Pack	Cu. Ft.
1003TR	3 oz, 3 $\frac{7}{8}$ " Diameter x $\frac{3}{4}$ " Height, Sauce Dish	Dozen	54.01	5	50	2.04
102.8TR	2 oz, 3 $\frac{1}{2}$ " Diameter x $\frac{3}{8}$ " Height, Sauce Dish	Dozen	64.77	5	80	1.89
1101TR	1 oz, 2 $\frac{3}{4}$ " Diameter x $\frac{5}{8}$ " Height, Sauce Dish	Dozen	42.97	5	80	1.22
1004TR	4 oz, 4 $\frac{1}{2}$ " Diameter x $\frac{3}{4}$ " Height, Round Plate	Dozen	26.01	1	12	0.90
1102TR	2 oz, 3 $\frac{3}{8}$ " x 2 $\frac{3}{4}$ " x $\frac{1}{2}$ ", Twin Sauce Dish	Dozen	41.89	2	40	1.65

****Rice Ladle and Soup Spoon are not NSF Certified.****

Lotus



Platter • Soup Plate • Spoon •
Rice Bowl • Twin Sauce Dish



Lotus

MELAMINE



Item	Description	U/M	Weight Gross lbs	Inner Pack	Master Pack	Cu. Ft.
1006TB	6" Diameter x 1/2" Height, Round Plate	Dozen	60.63	1	24	1.96
1007TB	6 7/8" Diameter x 3/4" Height, Round Plate	Dozen	46.03	1	16	1.69
1008TB	7 1/8" Diameter x 5/8" Height, Round Plate	Dozen	55.12	1	12	1.86
1009TB	9 1/8" Diameter x 3/4" Height, Round Plate	Dozen	49.71	1	8	1.66
1010TB	10 3/8" Diameter x 7/8" Height, Round Plate	Dozen	39.48	1	6	1.69
1012TB	11 3/4" Diameter x 7/8" Height, Round Plate	Dozen	44.25	1	4	1.62
1013TB	12 5/8" Diameter x 1" Height, Round Plate	Dozen	43.21	0.50	3	1.77
1014TB	14 1/8" Diameter x 1 1/8" Height, Round Plate	Dozen	51.81	0.50	3	2.22
1016TB	15 1/2" Diameter x 1 1/4" Height, Round Plate	Dozen	48.50	0.50	2	2.62
1015TB	14 3/8" Diameter x 1 3/4" Height, Narrow Rim Round Plate	Dozen	48.50	0.50	2	3.21



Item	Description	U/M	Weight Gross lbs	Inner Pack	Master Pack	Cu. Ft.
1106TB	3 oz, 6" Diameter x 1" Height, Soup Plate	Dozen	48.50	1	18	1.52
1107TB	5 oz, 7" Diameter x 1" Height, Soup Plate	Dozen	52.91	1	16	1.89
1108TB	7 oz, 7 7/8" Diameter x 1" Height, Soup Plate	Dozen	50.04	1	12	1.92
1109TB	10 oz, 9 1/4" Diameter x 1 1/4" Height, Soup Plate	Dozen	68.12	1	10	2.49
1110TB	12 oz, 10 3/8" Diameter x 1 1/4" Height, Soup Plate	Dozen	65.70	1	8	2.41





2109TB



2110TB



2112TB



2113TB



2114TB

Item	Description	U/M	Weight Gross lbs	Inner Pack	Master Pack	Cu. Ft.
2109TB	7 oz, 9" x 6 ³ / ₄ " x 1 ¹ / ₈ ", Deep Platter	Dozen	53.79	1	10	1.81
2110TB	9 oz, 10" x 7 ¹ / ₂ " x 1 ¹ / ₈ ", Deep Platter	Dozen	51.15	1	8	1.76
2112TB	16 oz, 12" x 9" x 1 ⁵ / ₈ ", Deep Platter	Dozen	58.30	1	6	2.49
2113TB	24 oz, 13" x 9 ³ / ₄ " x 1 ⁵ / ₈ ", Deep Platter	Dozen	49.60	1	4	1.97
2114TB	28 oz, 14 ¹ / ₈ " x 10 ⁵ / ₈ " x 1 ³ / ₄ ", Deep Platter	Dozen	53.57	1	4	2.37



2008TB



2009TB



2010TB



2012TB



2014TB



2016TB

Item	Description	U/M	Weight Gross lbs	Inner Pack	Master Pack	Cu. Ft.
2008TB	8" x 6" x 5 ⁸ / ₁₆ ", Platter	Dozen	54.01	1	16	2.65
2009TB	9" x 6 ⁵ / ₁₆ " x 3 ⁴ / ₁₆ ", Platter	Dozen	41.23	1	10	1.84
2010TB	9 ⁷ / ₁₆ " x 7 ¹ / ₄ " x 3 ⁴ / ₁₆ ", Platter	Dozen	50.86	1	8	1.90
2012TB	12" x 8 ⁵ / ₁₆ " x 7 ⁸ / ₁₆ ", Platter	Dozen	48.50	1	6	2.06
2014TB	14" x 10" x 1 ¹ / ₈ ", Platter	Dozen	34.94	0.50	3	2.18
2016TB	16" x 11 ⁵ / ₁₆ " x 11 ¹ / ₄ ", Platter	Dozen	51.81	0.50	3	2.13

Lotus



5060TB



5065TB



5070TB



5075TB



5085TB



5095TB

Item	Description	U/M	Weight Gross lbs	Inner Pack	Master Pack	Cu. Ft.
5060TB	22 oz, 6 $\frac{1}{8}$ " Diameter x 2 $\frac{1}{4}$ " Height, Rimless Bowl	Dozen	37.92	1	8	2.07
5065TB	32 oz, 7 $\frac{1}{2}$ " Diameter x 2 $\frac{1}{2}$ " Height, Rimless Bowl	Dozen	43.98	1	8	2.59
5070TB	36 oz, 8" Diameter x 2 $\frac{5}{8}$ " Height, Rimless Bowl	Dozen	41.45	1	6	2.10
5075TB	52 oz, 8 $\frac{3}{4}$ " Diameter x 2 $\frac{7}{8}$ " Height, Rimless Bowl	Dozen	47.18	1	6	2.43
5085TB	70 oz, 9 $\frac{3}{4}$ " Diameter x 3 $\frac{1}{4}$ " Height, Rimless Bowl	Dozen	48.06	0.50	4	3.24
5095TB	96 oz, 11" Diameter x 3 $\frac{3}{4}$ " Height, Rimless Bowl	Dozen	51.15	0.50	3	3.66



5206TB



5207TB



5208TB



5265TB



5275TB



5285TB

Item	Description	U/M	Weight Gross lbs	Inner Pack	Master Pack	Cu. Ft.
5206TB	25 oz, 5 $\frac{7}{8}$ " Diameter x 2 $\frac{5}{8}$ " Height, Rice Bowl	Dozen	26.46	1	6	1.35
5207TB	39 oz, 7 $\frac{1}{2}$ " Diameter x 3 $\frac{1}{4}$ " Height, Rice Bowl	Dozen	37.15	1	6	2.11
5208TB	56 oz, 8" Diameter x 3 $\frac{1}{2}$ " Height, Rice Bowl	Dozen	41.29	1	6	2.50
5265TB	25 oz, 6 $\frac{1}{4}$ " Diameter x 2 $\frac{3}{4}$ " Height, Scalloped Bowl	Dozen	39.68	1	6	1.92
5275TB	34 oz, 7 $\frac{1}{4}$ " Diameter x 3" Height, Scalloped Bowl	Dozen	40.79	1	6	1.82
5285TB	53 oz, 8 $\frac{1}{4}$ " Diameter x 3 $\frac{1}{2}$ " Height, Scalloped Bowl	Dozen	60.63	0.50	6	3.60



5306TB



5307TB



5308TB



5309TB



5008TB



5106TB



5107TB



5108TB

Item	Description	U/M	Weight Gross lbs	Inner Pack	Master Pack	Cu. Ft.
5306TB	21 oz, 6" Diameter x 2½" Height, Swirl Bowl	Dozen	29.10	1	6	1.29
5307TB	32 oz, 6⅞" Diameter x 2¾" Height, Swirl Bowl	Dozen	37.48	1	6	1.58
5308TB	48 oz, 8" Diameter x 3⅛" Height, Swirl Bowl	Dozen	51.15	0.50	6	2.94
5309TB	72 oz, 9" Diameter x 3½" Height, Swirl Bowl	Dozen	37.92	0.50	3	2.16
5008TB	35 oz, 8" Diameter x 2⅝" Height, Special Deep Bowl	Dozen	41.89	1	6	2.27
5106TB	15 oz, 6" Diameter x 2" Height, Deep Bowl	Dozen	39.24	1	12	1.76
5107TB	24 oz, 7" Diameter x 2¼" Height, Deep Bowl	Dozen	39.68	1	8	1.46
5108TB	34 oz, 8" Diameter x 2½" Height, Deep Bowl	Dozen	50.71	1	8	2.47



8010TB



8011TB



3201TB (Bowl)



3201CTB (Lid)

(Lid & Bowl are sold separately)

Item	Description	U/M	Weight Gross lbs	Inner Pack	Master Pack	Cu. Ft.
8010TB	75 oz, 10" Diameter x 3⅝" Height, Serving Bowl with Lid	Each	23.15	1	12	3.15
8011TB	80 oz, 11" Diameter x 3¼" Height, Serving Bowl with Lid	Each	29.76	1	12	3.60
3201TB	20 oz, 5¾" Diameter x 3" Height, Noodle Bowl (Lid Sold Separately)	Dozen	29.76	1	6	1.19
3201CTB	5 ¼" Diameter, Lid Only for 3201TB	Dozen	14.33	1	6	0.97

Lotus



9152TB Tea • Cup
Enlarged to show detail



3004TB



3006TB



3008TB



9152TB

Item	Description	U/M	Weight Gross lbs	Inner Pack	Master Pack	Cu. Ft.
3004TB	12 oz, 4 $\frac{7}{8}$ " Diameter x 2 $\frac{3}{8}$ " Height, Rice Bowl	Dozen	54.54	1	18	2.63
3006TB	9 oz, 4 $\frac{3}{8}$ " Diameter x 2 $\frac{1}{8}$ " Height, Rice Bowl	Dozen	52.36	1	24	2.60
3008TB	6 oz, 3 $\frac{3}{4}$ " Diameter x 2" Height, Rice Bowl	Dozen	42.99	2	24	1.79
9152TB	5 oz, 3 $\frac{1}{8}$ " Diameter x 2 $\frac{1}{8}$ " Height, Tea Cup	Dozen	54.67	1	30	2.94



7005B • Rice Ladle
Enlarged to show detail



7005B



7007B



7004TB



7003B



7100TB

Item	Description	U/M	Weight Gross lbs	Inner Pack	Master Pack	Cu. Ft.
7005B	1 $\frac{1}{2}$ oz, 8 $\frac{1}{4}$ x 2 $\frac{3}{4}$ ", Rice Ladle	Dozen	48.05	2	30	2.38
7007B	2 $\frac{1}{2}$ oz, 8 $\frac{7}{8}$ " x 2 $\frac{3}{4}$ ", Ladle/Spoon	Dozen	44.78	2	30	2.55
7004TB	$\frac{3}{4}$ oz, 5 $\frac{5}{8}$ " x 1 $\frac{3}{4}$ ", Spoon	Dozen	52.66	5	100	2.26
7003B	$\frac{3}{4}$ oz, 5 $\frac{3}{4}$ " x 1 $\frac{3}{4}$ ", Won Ton Soup Spoon	Dozen	52.58	5	100	2.26
7100TB	1 oz, 6 $\frac{1}{4}$ " x 1 $\frac{3}{4}$ ", Soup Spoon	Dozen	45.48	5	60	2.21

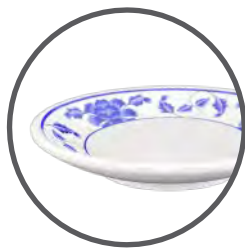

1004TB • Round Plate
Enlarged to show detail



1003TB



102.8TB



1101TB



1004TB



1102TB

Item	Description	U/M	Weight Gross lbs	Inner Pack	Master Pack	Cu. Ft.
1003TB	3 oz, 3 $\frac{7}{8}$ " Diameter x $\frac{3}{4}$ " Height, Sauce Dish	Dozen	54.01	5	50	2.04
102.8TB	2 oz, 3 $\frac{1}{2}$ " Diameter x $\frac{3}{8}$ " Height, Sauce Dish	Dozen	64.77	5	80	1.89
1101TB	1 oz, 2 $\frac{3}{4}$ " Diameter x $\frac{5}{8}$ " Height, Sauce Dish	Dozen	42.97	5	80	1.22
1004TB	4 oz, 4 $\frac{1}{2}$ " Diameter x $\frac{3}{4}$ " Height, Round Plate	Dozen	26.01	1	12	0.90
1102TB	2 oz, 3 $\frac{3}{8}$ " x 2 $\frac{3}{4}$ " x $\frac{1}{2}$ ", Twin Sauce Dish	Dozen	41.89	2	40	1.65

Rice Ladle and Soup Spoon are not NSF Certified.



Peacock

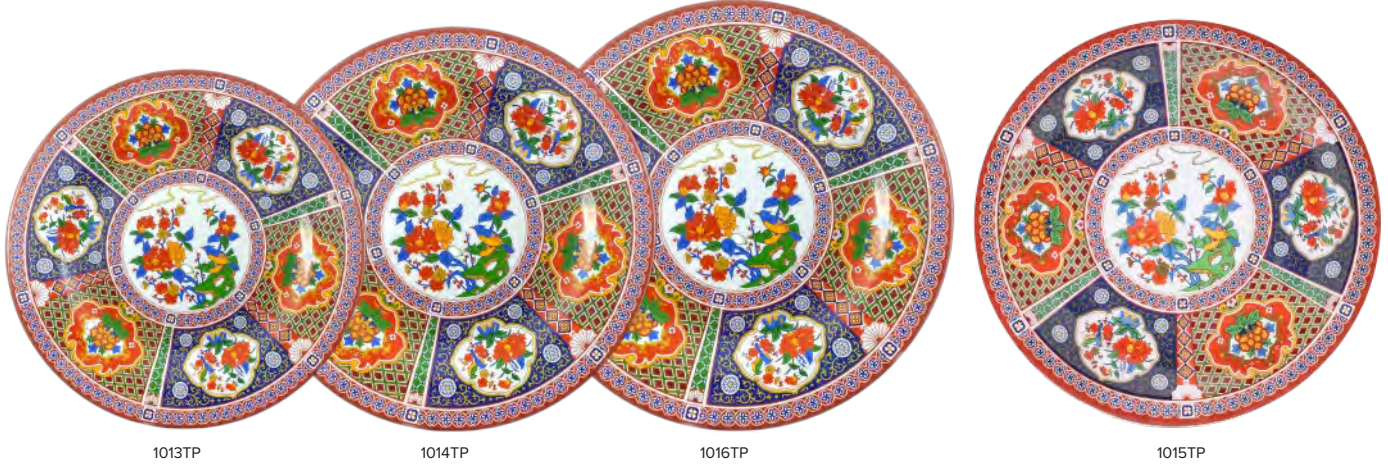
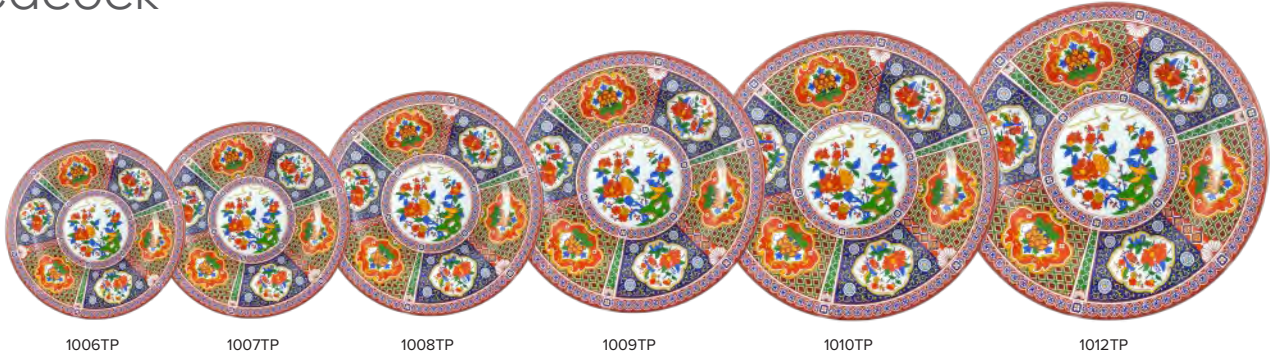

Plate • Soup Plate • Spoon •
Rice Bowl • Lid • Bowl • Tea Cup



Peacock

MELAMINE



Item	Description	U/M	Weight Gross lbs	Inner Pack	Master Pack	Cu. Ft.
1006TP	6" Diameter x 1/2" Height, Round Plate	Dozen	60.63	1	24	1.96
1007TP	6 7/8" Diameter x 3/4" Height, Round Plate	Dozen	46.03	1	16	1.69
1008TP	7 1/2" Diameter x 5/8" Height, Round Plate	Dozen	55.12	1	12	1.86
1009TP	9 1/8" Diameter x 3/4" Height, Round Plate	Dozen	49.71	1	8	1.66
1010TP	10 3/8" Diameter x 7/8" Height, Round Plate	Dozen	39.48	1	6	1.69
1012TP	11 3/4" Diameter x 7/8" Height, Round Plate	Dozen	44.25	1	4	1.62
1013TP	12 5/8" Diameter x 1" Height, Round Plate	Dozen	43.21	0.50	3	1.77
1014TP	14 1/8" Diameter x 1 1/8" Height, Round Plate	Dozen	51.81	0.50	3	2.22
1016TP	15 1/2" Diameter x 1 1/4" Height, Round Plate	Dozen	48.50	0.50	2	2.62
1015TP	14 3/8" Diameter x 1 3/4" Height, Narrow Rim Round Plate	Dozen	48.50	0.50	2	3.21



Item	Description	U/M	Weight Gross lbs	Inner Pack	Master Pack	Cu. Ft.
1106TP	3 oz, 6" Diameter x 1" Height, Soup Plate	Dozen	48.50	1	18	1.52
1107TP	5 oz, 7" Diameter x 1" Height, Soup Plate	Dozen	52.91	1	16	1.89
1108TP	7 oz, 7 7/8" Diameter x 1" Height, Soup Plate	Dozen	50.04	1	12	1.92
1109TP	10 oz, 9 1/4" Diameter x 1 1/4" Height, Soup Plate	Dozen	68.12	1	10	2.49
1110TP	12 oz, 10 3/8" Diameter x 1 1/4" Height, Soup Plate	Dozen	65.70	1	8	2.41





2109TP



2110TP



2112TP



2113TP



2114TP

Item	Description	U/M	Weight Gross lbs	Inner Pack	Master Pack	Cu. Ft.
2109TP	7 oz, 9" x 6 $\frac{3}{4}$ " x 1 $\frac{1}{8}$ ", Deep Platter	Dozen	53.79	1	10	1.81
2110TP	9 oz, 10" x 7 $\frac{1}{2}$ " x 1 $\frac{1}{8}$ ", Deep Platter	Dozen	51.15	1	8	1.76
2112TP	16 oz, 12" x 9" x 1 $\frac{5}{8}$ ", Deep Platter	Dozen	58.30	1	6	2.49
2113TP	24 oz, 13" x 9 $\frac{3}{4}$ " x 1 $\frac{5}{8}$ ", Deep Platter	Dozen	49.60	1	4	1.97
2114TP	28 oz, 14 $\frac{1}{8}$ " x 10 $\frac{5}{8}$ " x 1 $\frac{3}{4}$ ", Deep Platter	Dozen	53.57	1	4	2.37



2008TP



2009TP



2010TP



2012TP



2014TP



2016TP

Item	Description	U/M	Weight Gross lbs	Inner Pack	Master Pack	Cu. Ft.
2008TP	8" x 6" x $\frac{5}{8}$ ", Platter	Dozen	54.01	1	16	2.65
2009TP	9" x 6 $\frac{5}{8}$ " x $\frac{3}{4}$ ", Platter	Dozen	41.23	1	10	1.84
2010TP	9 $\frac{7}{8}$ " x 7 $\frac{1}{4}$ " x $\frac{3}{4}$ ", Platter	Dozen	50.86	1	8	1.90
2012TP	12" x 8 $\frac{5}{8}$ " x $\frac{7}{8}$ ", Platter	Dozen	48.50	1	6	2.06
2014TP	14" x 10" x 1 $\frac{1}{8}$ ", Platter	Dozen	34.94	0.50	3	2.18
2016TP	16" x 11 $\frac{5}{8}$ " x 1 $\frac{1}{4}$ ", Platter	Dozen	51.81	0.50	3	2.13

Peacock

MELAMINE



5060TP



5065TP



5070TP



5075TP



5085TP



5095TP

Item	Description	U/M	Weight Gross lbs	Inner Pack	Master Pack	Cu.Ft
5060TP	22 oz, 6 $\frac{7}{8}$ " Diameter x 2 $\frac{1}{4}$ " Height, Rimless Bowl	Dozen	37.92	1	8	2.07
5065TP	32 oz, 7 $\frac{1}{2}$ " Diameter x 2 $\frac{1}{2}$ " Height, Rimless Bowl	Dozen	43.98	1	8	2.59
5070TP	36 oz, 8" Diameter x 2 $\frac{5}{8}$ " Height, Rimless Bowl	Dozen	41.45	1	6	2.10
5075TP	52 oz, 8 $\frac{3}{4}$ " Diameter x 2 $\frac{7}{8}$ " Height, Rimless Bowl	Dozen	47.18	1	6	2.43
5085TP	70 oz, 9 $\frac{3}{4}$ " Diameter x 3 $\frac{1}{4}$ " Height, Rimless Bowl	Dozen	48.06	0.50	4	3.24
5095TP	96 oz, 11" Diameter x 3 $\frac{3}{4}$ " Height, Rimless Bowl	Dozen	51.15	0.50	3	3.66



5206TP



5207TP



5208TP



5265TP



5275TP



5285TP

Item	Description	U/M	Weight Gross lbs	Inner Pack	Master Pack	Cu.Ft
5206TP	25 oz, 5 $\frac{7}{8}$ " Diameter x 2 $\frac{7}{8}$ " Height, Rice Bowl	Dozen	26.46	1	6	1.35
5207TP	39 oz, 7" Diameter x 3 $\frac{1}{4}$ " Height, Rice Bowl	Dozen	37.15	1	6	2.11
5208TP	56 oz, 8" Diameter x 3 $\frac{1}{2}$ " Height, Rice Bowl	Dozen	41.29	1	6	2.50
5265TP	25 oz, 6 $\frac{1}{4}$ " Diameter x 2 $\frac{3}{4}$ " Height, Scalloped Bowl	Dozen	39.68	1	8	1.92
5275TP	34 oz, 7 $\frac{1}{4}$ " Diameter x 3" Height, Scalloped Bowl	Dozen	40.79	1	6	1.82
5285TP	53 oz, 8 $\frac{1}{4}$ " Diameter x 3 $\frac{1}{2}$ " Height, Scalloped Bowl	Dozen	60.63	0.50	6	3.60



5106TP



5107TP



5108TP



5306TP



5307TP



5308TP



5309TP

Item	Description	U/M	Weight Gross lbs	Inner Pack	Master Pack	Cu. Ft.
5106TP	15 oz, 6" Diameter x 2" Height, Deep Bowl	Dozen	39.24	1	12	1.76
5107TP	24 oz, 7" Diameter x 2¼" Height, Deep Bowl	Dozen	39.68	1	8	1.46
5108TP	34 oz, 8" Diameter x 2½" Height, Deep Bowl	Dozen	50.71	1	8	2.47
5306TP	21 oz, 6" Diameter x 2½" Height, Swirl Bowl	Dozen	29.10	1	6	1.29
5307TP	32 oz, 6¾" Diameter x 2¾" Height, Swirl Bowl	Dozen	37.48	1	6	1.58
5308TP	48 oz, 8" Diameter x 3½" Height, Swirl Bowl	Dozen	51.15	0.50	6	2.94
5309TP	72 oz, 9" Diameter x 3½" Height, Swirl Bowl	Dozen	37.92	0.50	3	2.16



8010TP



8011TP



3201TP (Bowl)
(Lid & Bowl are sold separately)



3201CTP (Lid)

Item	Description	U/M	Weight Gross lbs	Inner Pack	Master Pack	Cu. Ft.
8010TP	75 oz, 10" Diameter x 3½" Height, Serving Bowl with Lid	Each	23.15	1	12	3.15
8011TP	80 oz, 11" Diameter x 3¼" Height, Serving Bowl with Lid	Each	29.76	1	12	3.60
3201TP	20 oz, 5¾" Diameter x 3" Height, Noodle Bowl (Lid Sold Separately)	Dozen	29.76	1	6	1.19
3201CTP	5¼" Diameter, Lid only for 3201TP	Dozen	14.33	1	6	0.97

Peacock



9152TB • Tea Cup
Enlarged to show detail



3004TP



3006TP



3008TP



9152TP

Item	Description	U/M	Weight Gross lbs	Inner Pack	Master Pack	Cu. Ft.
3004TP	12 oz, 4 $\frac{7}{8}$ " Diameter x 2 $\frac{3}{8}$ " Height, Rice Bowl	Dozen	54.54	1	18	2.63
3006TP	9 oz, 4 $\frac{3}{8}$ " Diameter x 2 $\frac{1}{8}$ " Height, Rice Bowl	Dozen	52.36	1	24	2.60
3008TP	6 oz, 3 $\frac{3}{4}$ " Diameter x 2" Height, Rice Bowl	Dozen	42.99	2	24	1.79
9152TP	5 oz, 3 $\frac{1}{8}$ " Diameter x 2 $\frac{1}{8}$ " Height, Tea Cup	Dozen	54.67	1	30	2.94

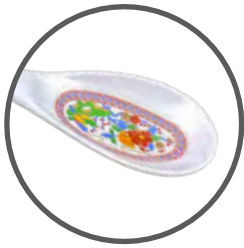

7005P • Rice Ladle
Enlarged to show detail



7002TP



7003P



7004TP



7005P

Item	Description	U/M	Weight Gross lbs	Inner Pack	Master Pack	Cu. Ft.
7002TP	$\frac{1}{2}$ oz, 4 $\frac{7}{8}$ " x 1 $\frac{5}{8}$ ", Spoon	Dozen	60.63	5	100	1.99
7003P	$\frac{3}{4}$ oz, 5 $\frac{3}{4}$ " x 1 $\frac{3}{4}$ ", Won Ton Soup Spoon	Dozen	52.58	5	100	2.26
7004TP	$\frac{3}{4}$ oz, 5 $\frac{5}{8}$ " x 1 $\frac{3}{4}$ ", Spoon	Dozen	52.66	5	100	2.26
7005P	1 $\frac{1}{2}$ oz, 8 $\frac{1}{4}$ " x 2 $\frac{3}{4}$ ", Rice Ladle	Dozen	48.50	2	30	2.38



1004TB • Round Plate
Enlarged to show detail



102.8TP



1101TP



1003TP



1004TP



1102TP

Item	Description	U/M	Weight Gross lbs	Inner Pack	Master Pack	Cu. Ft.
102.8TP	2 oz, 3 $\frac{1}{2}$ " Diameter x $\frac{3}{8}$ " Height, Sauce Dish	Dozen	64.77	5	80	1.89
1101TP	1 oz, 2 $\frac{3}{4}$ " Diameter x $\frac{5}{8}$ " Height, Sauce Dish	Dozen	42.97	5	80	1.22
1003TP	3 oz, 3 $\frac{3}{8}$ " Diameter x $\frac{3}{4}$ " Height, Sauce Dish	Dozen	54.01	5	50	2.04
1004TP	4 oz, 4 $\frac{1}{2}$ " Diameter x $\frac{3}{4}$ " Height, Round Plate	Dozen	26.01	1	12	0.90
1102TP	2 oz, 3 $\frac{3}{8}$ " x 2 $\frac{3}{4}$ " x $\frac{1}{2}$ ", Twin Sauce Dish	Dozen	41.89	2	40	1.65

****Rice Ladle and Soup Spoon are not NSF Certified.****



Rose



Soup Plates • Platter • Rice
Bowl • Rimless Bowl • Tea Cup •
Sauce Dish



Rose



Item	Description	U/M	Weight Gross lbs	Inner Pack	Master Pack	Cu. Ft.
1006AR	6" Diameter x 1/2" Height, Round Plate	Dozen	60.63	1	24	1.96
1007AR	6 7/8" Diameter x 3/4" Height, Round Plate	Dozen	46.03	1	16	1.69
1008AR	7 7/8" Diameter x 5/8" Height, Round Plate	Dozen	55.12	1	12	1.86
1009AR	9 1/8" Diameter x 3/4" Height, Round Plate	Dozen	49.71	1	8	1.66
1010AR	10 3/8" Diameter x 7/8" Height, Round Plate	Dozen	39.48	1	6	1.69
1012AR	11 3/4" Diameter x 7/8" Height, Round Plate	Dozen	44.25	1	4	1.62
1013AR	12 5/8" Diameter x 1" Height, Round Plate	Dozen	43.21	0.50	3	1.77
1014AR	14 1/8" Diameter x 1 1/8" Height, Round Plate	Dozen	51.81	0.50	3	2.22
1016AR	15 1/2" Diameter x 1 1/4" Height, Round Plate	Dozen	48.50	0.50	2	2.62
1015AR	14 3/8" Diameter x 1 3/4" Height, Narrow Round Plate	Dozen	48.50	0.50	2	3.21



Item	Description	U/M	Weight Gross lbs	Inner Pack	Master Pack	Cu. Ft.
1106AR	3 oz, 6" Diameter x 1" Height, Soup Plate	Dozen	48.50	1	18	1.52
1107AR	5 oz, 7" Diameter x 1" Height, Soup Plate	Dozen	52.91	1	16	1.89
1108AR	7 oz, 7 7/8" Diameter x 1" Height, Soup Plate	Dozen	50.04	1	12	1.92
1109AR	10 oz, 9 1/4" Diameter x 1 1/4" Height, Soup Plate	Dozen	68.12	1	10	2.49
1110AR	12 oz, 10 3/8" Diameter x 1 1/4" Height, Soup Plate	Dozen	65.70	1	8	2.41



2109AR



2110AR



2112AR



2113AR



2114AR

Item	Description	U/M	Weight Gross lbs	Inner Pack	Master Pack	Cu. Ft.
2109AR	7 oz, 9" x 6 ³ / ₄ " x 1 ¹ / ₈ ", Deep Platter	Dozen	53.79	1	10	1.81
2110AR	9 oz, 10" x 7 ¹ / ₂ " x 1 ¹ / ₈ ", Deep Platter	Dozen	51.15	1	8	1.76
2112AR	16 oz, 12" x 9" x 1 ⁵ / ₈ ", Deep Platter	Dozen	58.30	1	6	2.49
2113AR	24 oz, 13" x 9 ³ / ₄ " x 1 ⁵ / ₈ ", Deep Platter	Dozen	49.60	1	4	1.97
2114AR	28 oz, 14 ¹ / ₈ " x 10 ⁵ / ₈ " x 1 ³ / ₄ ", Deep Platter	Dozen	53.57	1	4	2.37



2008AR



2009AR



2010AR



2012AR



2014AR



2016AR

Item	Description	U/M	Weight Gross lbs	Inner Pack	Master Pack	Cu. Ft.
2008AR	8" x 6" x 5/8", Platter	Dozen	54.01	1	16	2.65
2009AR	9" x 6 ⁵ / ₈ " x 3/4", Platter	Dozen	41.23	1	10	1.84
2010AR	9 ⁷ / ₈ " x 7 1/4" x 3/4", Platter	Dozen	50.86	1	8	1.90
2012AR	12" x 8 ⁵ / ₈ " x 7/8", Platter	Dozen	48.50	1	6	2.06
2014AR	14" x 10" x 1 ¹ / ₈ ", Platter	Dozen	34.94	0.50	3	2.18
2016AR	16" x 11 ⁵ / ₈ " x 1 ¹ / ₄ ", Platter	Dozen	51.81	0.50	3	2.13

Rose



5060AR



5065AR



5070AR



5075AR



5085AR



5095AR

Item	Description	U/M	Weight Gross lbs	Inner Pack	Master Pack	Cu. Ft.
5060AR	22 oz, 6 $\frac{7}{8}$ " Diameter x 2 $\frac{1}{4}$ " Height, Rimless Bowl	Dozen	37.92	1	8	2.07
5065AR	32 oz, 7 $\frac{1}{2}$ " Diameter x 2 $\frac{1}{2}$ " Height, Rimless Bowl	Dozen	43.98	1	8	2.59
5070AR	36 oz, 8" Diameter x 2 $\frac{5}{8}$ " Height, Rimless Bowl	Dozen	41.45	1	6	2.10
5075AR	52 oz, 8 $\frac{3}{4}$ " Diameter x 2 $\frac{7}{8}$ " Height, Rimless Bowl	Dozen	47.18	1	6	2.43
5085AR	70 oz, 9 $\frac{3}{4}$ " Diameter x 3 $\frac{1}{4}$ " Height, Rimless Bowl	Dozen	48.06	0.5	4	3.24
5095AR	96 oz, 11" Diameter x 3 $\frac{3}{4}$ " Height, Rimless Bowl	Dozen	51.15	0.5	3	3.66



5206AR



5207AR



5208AR



5306AR



5307AR



5308AR



5309AR

Item	Description	U/M	Weight Gross lbs	Inner Pack	Master Pack	Cu. Ft.
5206AR	25 oz, 5 $\frac{7}{8}$ " Diameter x 2 $\frac{7}{8}$ " Height, Rice Bowl	Dozen	26.46	1	6	1.35
5207AR	39 oz, 7" Diameter x 3 $\frac{1}{4}$ " Height, Rice Bowl	Dozen	37.15	1	6	2.11
5208AR	56 oz, 8" Diameter x 3 $\frac{1}{2}$ " Height, Rice Bowl	Dozen	41.29	1	6	2.50
5306AR	21 oz, 6" Diameter x 2 $\frac{1}{2}$ " Height, Swirl Bowl	Dozen	29.10	1	6	1.29
5307AR	32 oz, 6 $\frac{7}{8}$ " Diameter x 2 $\frac{3}{4}$ " Height, Swirl Bowl	Dozen	37.48	1	6	1.58
5308AR	48 oz, 8" Diameter x 3 $\frac{1}{8}$ " Height, Swirl Bowl	Dozen	51.15	0.50	6	2.94
5309AR	72 oz, 9" Diameter x 3 $\frac{1}{2}$ " Height, Swirl Bowl	Dozen	37.92	0.50	3	2.16





5106AR



5107AR



5108AR



5265AR



5275AR



5285AR

Item	Description	U/M	Weight Gross lbs	Inner Pack	Master Pack	Cu. Ft.
5106AR	15 oz, 6" Diameter x 2" Height, Deep Bowl	Dozen	39.24	1	12	1.76
5107AR	24 oz, 7" Diameter x 2¼" Height, Deep Bowl	Dozen	39.68	1	8	1.46
5108AR	34 oz, 8" Diameter x 2½" Height, Deep Bowl	Dozen	50.71	1	8	2.47
5265AR	25 oz, 6¼" Diameter x 2¾" Height, Scalloped Bowl	Dozen	39.68	1	8	1.92
5275AR	34 oz, 7¼" Diameter x 3" Height, Scalloped Bowl	Dozen	40.79	1	6	1.82
5285AR	53 oz, 8¼" Diameter x 3½" Height, Scalloped Bowl	Dozen	60.63	0.50	6	3.60



8010AR



8011AR



3201AR (Bowl)
(Lid & Bowl are sold separately)



3201CAR (Lid)

Item	Description	U/M	Weight Gross lbs	Inner Pack	Master Pack	Cu. Ft.
8010AR	75 oz, 10" Diameter x 3⅛" Height, Serving Bowl with Lid	Each	23.15	1	12	3.15
8011AR	80 oz, 11" Diameter x 3¼" Height, Serving Bowl with Lid	Each	29.76	1	12	3.60
3201AR	20 oz, 5¾" Diameter x 3" Height, Noodle Bowl (Lid Sold Separately)	Dozen	29.76	1	6	1.19
3201CAR	5¼" Diameter, Lid only for 3201AR	Dozen	14.33	1	6	0.97

Rose



9152TB • Tea Cup
Enlarged to show detail



3004AR



3006AR



3008AR



9152AR

Item	Description	U/M	Weight Gross lbs	Inner Pack	Master Pack	Cu. Ft.
3004AR	12 oz, 4 $\frac{7}{8}$ " Diameter x 2 $\frac{3}{8}$ " Height, Rice Bowl	Dozen	54.54	1	18	2.63
3006AR	9 oz, 4 $\frac{3}{8}$ " Diameter x 2 $\frac{1}{8}$ " Height, Rice Bowl	Dozen	52.36	1	24	2.60
3008AR	6 oz, 3 $\frac{3}{4}$ " Diameter x 2" Height, Rice Bowl	Dozen	42.99	2	24	1.79
9152AR	5 oz, 3 $\frac{1}{8}$ " Diameter x 2 $\frac{1}{8}$ " Height, Tea Cup	Dozen	54.67	1	30	2.94



7005AR • Rice Ladle
Enlarged to show detail



7003AR



7004AR



7005AR

Item	Description	U/M	Weight Gross lbs	Inner Pack	Master Pack	Cu. Ft.
7003AR	$\frac{3}{4}$ oz, 5 $\frac{3}{4}$ " x 1 $\frac{3}{4}$ ", Won Ton Soup Spoon	Dozen	52.58	5	100	2.26
7004AR	$\frac{3}{4}$ oz, 5 $\frac{5}{8}$ " x 1 $\frac{3}{4}$ ", Spoon	Dozen	52.66	5	100	2.26
7005AR	1 $\frac{1}{2}$ oz, 8 $\frac{1}{4}$ " x 2 $\frac{3}{4}$ ", Rice Ladle	Dozen	48.50	2	30	2.38

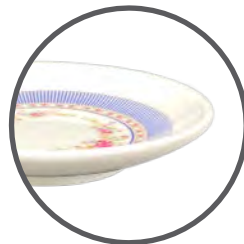

1004AR • Round Plate
Enlarged to show detail



1003AR



102.8AR



1101AR



1004AR



1102AR

Item	Description	U/M	Weight Gross lbs	Inner Pack	Master Pack	Cu. Ft.
1003AR	3 oz, 3 $\frac{5}{8}$ " Diameter x $\frac{3}{4}$ " Height, Sauce Dish	Dozen	54.01	5	50	2.04
102.8AR	2 oz, 3 $\frac{1}{2}$ " Diameter x $\frac{3}{8}$ " Height, Sauce Dish	Dozen	64.77	5	80	1.89
1101AR	1 oz, 2 $\frac{3}{4}$ " Diameter x $\frac{5}{8}$ " Height, Sauce Dish	Dozen	42.97	5	80	1.22
1004AR	4 oz, 4 $\frac{1}{2}$ " Diameter x $\frac{3}{4}$ " Height, Round Plate	Dozen	26.01	1	12	0.90
1102AR	2 oz, 3 $\frac{3}{8}$ " x 2 $\frac{3}{4}$ " x $\frac{1}{2}$ ", Twin Sauce Dish	Dozen	41.89	2	40	1.65

****Rice Ladle and Soup Spoon are not NSF Certified.****

Blue Bamboo



Platter • Plates • Deep Bowl •
Sauce Bowl • Soup Ladle



Blue Bamboo



Item	Description	U/M	Weight Gross lbs	Inner Pack	Master Pack	Cu. Ft.
1006BB	6" Diameter x 1/2" Height, Round Plate	Dozen	60.63	1	24	1.96
1007BB	6 7/8" Diameter x 3/4" Height, Round Plate	Dozen	46.03	1	16	1.69
1008BB	7 1/8" Diameter x 5/8" Height, Round Plate	Dozen	55.12	1	12	1.86
1009BB	9 1/8" Diameter x 3/4" Height, Round Plate	Dozen	49.71	1	8	1.66
1010BB	10 3/8" Diameter x 7/8" Height, Round Plate	Dozen	39.48	1	6	1.69
1012BB	11 3/4" Diameter x 7/8" Height, Round Plate	Dozen	44.25	1	4	1.62
1014BB	14 1/8" Diameter x 1" Height, Round Plate	Dozen	51.81	0.50	3	2.22

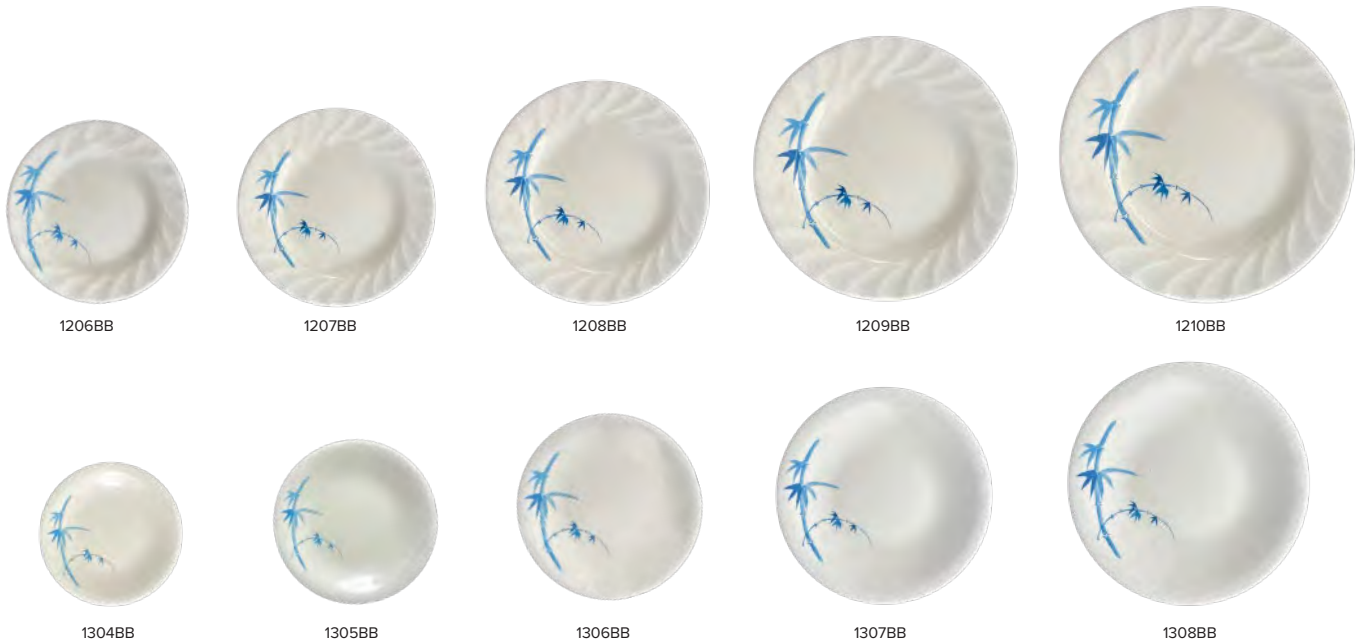

Item	Description	U/M	Weight Gross lbs	Inner Pack	Master Pack	Cu. Ft.
1206BB	6" Diameter x 3/4" Height, Curved Rim Plate	Dozen	47.40	1	18	1.63
1207BB	7" Diameter x 1" Height, Curved Rim Plate	Dozen	60.19	1	16	2.20
1208BB	8" Diameter x 1 1/8" Height, Curved Rim Plate	Dozen	55.56	1	12	2.19
1209BB	9 1/4" Diameter x 1 1/8" Height, Curved Rim Plate	Dozen	52.47	1	8	2.17
1210BB	10 1/2" Diameter x 1 3/8" Height, Curved Rim Plate	Dozen	50.71	1	6	2.33
1304BB	4 3/4" Diameter x 5/8" Height, Dinner Plate	Dozen	36.16	1	24	1.42
1305BB	5 1/4" Diameter x 3/4" Height, Dinner Plate	Dozen	44.09	1	24	2.00
1306BB	6 3/8" Diameter x 3/4" Height, Dinner Plate	Dozen	34.17	1	12	1.57
1307BB	7 3/8" Diameter x 1" Height, Dinner Plate	Dozen	31.53	1	8	1.47
1308BB	8 5/8" Diameter x 1 1/8" Height, Dinner Plate	Dozen	24.25	1	4	1.13

Blue Bamboo

2024



1350BB



1360BB



1365BB



1203BB



2008BB



2009BB



2010BB



2012BB

Item	Description	U/M	Weight Gross lbs	Inner Pack	Master Pack	Cu. Ft.
1350BB	5½" Diameter x 1½" Height, Soup Plate	Dozen	27.56	1	12	1.41
1360BB	5¾" Diameter x ¾" Height, Plate	Dozen	38.80	1	12	2.53
1365BB	6½" Diameter x 1½" Height, Soup Plate	Dozen	40.12	1	12	2.15
1203BB	6" x 5½" x ¾", Oblong Platter	Dozen	36.38	1	12	1.26
2008BB	8" x 6" x 5⁄8", Platter	Dozen	54.01	1	16	2.65
2009BB	9" x 6½" x ¾", Platter	Dozen	41.23	1	10	1.84
2010BB	9¾" x 7¼" x ¾" Platter	Dozen	50.86	1	8	1.90
2012BB	12" x 8½" x 7⁄8", Platter	Dozen	48.50	1	6	2.06



0900BB



1501BB



1505BB



1535BB



1503BB



1504BB



1502BB



0011BB

Item	Description	U/M	Weight Gross lbs	Inner Pack	Master Pack	Cu. Ft.
0900BB	13½" x 4½" x 5⁄8", Sandwich Tray	Dozen	53.57	1	8	2.24
1501BB	8½" x 3¾" x 1", Vegetable Serving Plate	Dozen	28.66	1	6	1.06
1503BB	6¾" x 4½" x 1", Bamboo Plate	Dozen	44.09	1	12	1.87
1504BB	6¾" x 4½" x 1½", Barbecue Plate	Dozen	39.68	1	12	1.86
1505BB	8¼" x 5½" x 1", Barbecue Plate	Dozen	48.50	1	8	2.09
1535BB	5¼" x 3¼" x ¾", Plate	Dozen	31.53	1	12	1.24
1502BB	9 ⅜" x 4¼" x 1", Rectangular Barbecue Plate	Dozen	68.56	1	12	3.01
0011BB	8 ½" x 4 ¾" x 1 ½", Bamboo Sashimi Platter	Dozen	37.63	1	6	1.88

MELAMINE

Blue Bamboo



1607BB



1608BB



1609BB



0010BB



1201BB



1202BB

Item	Description	U/M	Weight Gross lbs	Inner Pack	Master Pack	Cu. Ft.
1607BB	2 oz, 4" x 2 $\frac{3}{4}$ " x $\frac{7}{8}$ ", Wavy Shape Sauce Dish	Dozen	33.29	1	24	1.35
1608BB	5 $\frac{3}{4}$ " x 4" x $\frac{3}{4}$ ", Wavy Shape Barbecue Plate	Dozen	31.08	1	12	1.18
1609BB	8 $\frac{1}{2}$ " x 5 $\frac{1}{2}$ " x $\frac{7}{8}$ ", Wavy Shape Barbecue Plate	Dozen	28.66	1	6	1.15
0010BB	6 $\frac{1}{2}$ " x 5 $\frac{1}{2}$ " x 1 $\frac{1}{8}$ ", Plate	Dozen	35.71	1	6	1.19
1201BB	4 $\frac{3}{4}$ " x 4 $\frac{1}{4}$ " x $\frac{5}{8}$ ", Plate	Dozen	29.83	1	12	0.89
1202BB	5 $\frac{1}{2}$ " x 4 $\frac{3}{4}$ " x $\frac{3}{4}$ ", Plate	Dozen	37.43	1	12	1.30



0901BB



0902BB



0903BB



2308BB



2309BB



2311BB

Item	Description	U/M	Weight Gross lbs	Inner Pack	Master Pack	Cu. Ft.
0901BB	13 $\frac{1}{8}$ " x 10 $\frac{1}{4}$ " x $\frac{3}{4}$ ", Tray	Dozen	19.00	0.50	2	0.96
0902BB	15 $\frac{1}{4}$ " x 11 $\frac{1}{2}$ " x $\frac{7}{8}$ ", Tray	Dozen	24.54	0.50	2	1.34
0903BB	17" x 12 $\frac{5}{8}$ " x 1", Tray	Dozen	33.16	0.50	2	1.69
2308BB	8" x 5 $\frac{3}{4}$ " x $\frac{3}{4}$ ", Teriyaki Tray	Dozen	22.22	1	6	0.75
2309BB	9" x 6 $\frac{1}{2}$ " x $\frac{7}{8}$ ", Teriyaki Tray	Dozen	32.23	1	6	1.00
2311BB	23 oz, 10 $\frac{3}{4}$ " x 7 $\frac{7}{8}$ " x 1", Teriyaki Tray	Dozen	33.05	1	4	1.06

Blue Bamboo

2024



5306BB



5307BB



5308BB



5309BB



5265BB



5275BB



5285BB

Item	Description	U/M	Weight Gross lbs	Inner Pack	Master Pack	Cu. Ft.
5306BB	21 oz, 6" Diameter x 2½" Height, Swirl Bowl	Dozen	29.10	1	6	1.29
5307BB	32 oz, 6¾" Diameter x 2¾" Height, Swirl Bowl	Dozen	37.48	1	6	1.58
5308BB	48 oz, 8" Diameter x 3½" Height, Swirl Bowl	Dozen	51.15	0.50	6	2.94
5309BB	72 oz, 9" Diameter x 3½" Height, Swirl Bowl	Dozen	37.92	0.50	3	2.16
5265BB	25 oz, 6¼" Diameter x 2¾" Height, Scalloped Bowl	Dozen	39.68	1	8	1.92
5275BB	34 oz, 7¼" Diameter x 3" Height, Scalloped Bowl	Dozen	40.79	1	6	1.82
5285BB	53 oz, 8¼" Diameter x 3½" Height, Scalloped Bowl	Dozen	60.63	0.50	6	3.60



5060BB



5065BB



5070BB



5075BB



5085BB



5095BB

Item	Description	U/M	Weight Gross lbs	Inner Pack	Master Pack	Cu. Ft.
5060BB	22 oz, 6¾" Diameter x 2¼" Height, Rimless Bowl	Dozen	37.92	1	8	2.07
5065BB	32 oz, 7½" Diameter x 2½" Height, Rimless Bowl	Dozen	43.98	1	8	2.59
5070BB	36 oz, 8" Diameter x 2⅝" Height, Rimless Bowl	Dozen	41.45	1	6	2.10
5075BB	52 oz, 8¾" Diameter x 2⅞" Height, Rimless Bowl	Dozen	47.18	1	6	2.43
5085BB	70 oz, 9¾" Diameter x 3¼" Height, Rimless Bowl	Dozen	48.06	0.50	4	3.24
5095BB	96 oz, 11" Diameter x 3¾" Height, Rimless Bowl	Dozen	51.15	0.50	3	3.66

MELAMINE

Blue Bamboo

MELAMINE



5106BB



5107BB



5108BB



5206BB



5207BB



5208BB



5008BB

Item	Description	U/M	Weight Gross lbs	Inner Pack	Master Pack	Cu. Ft.
5106BB	15 oz, 6" Diameter x 2" Height, Bowl	Dozen	39.24	1	12	1.76
5107BB	24 oz, 7" Diameter x 2¼" Height, Bowl	Dozen	39.68	1	8	1.46
5108BB	34 oz, 8" Diameter x 2½" Height, Bowl	Dozen	50.71	1	8	2.47
5206BB	25 oz, 5⅝" Diameter x 2⅞" Height, Rice Bowl	Dozen	26.46	1	6	1.35
5207BB	39 oz, 7" Diameter x 3¼" Height, Rice Bowl	Dozen	37.15	1	6	2.11
5208BB	56 oz, 8" Diameter x 3½" Height, Rice Bowl	Dozen	41.29	1	6	2.50
5008BB	35 oz, 8" Diameter x 2⅝" Height, Special Deep Bowl	Dozen	41.89	1	6	2.27



3001BB



3006BB



1035BB



3005BB



3540BB



3008BB



1036BB

Item	Description	U/M	Weight Gross lbs	Inner Pack	Master Pack	Cu. Ft.
3001BB	10 oz, 4½" Diameter x 1¾" Height, Bowl	Dozen	20.28	0.50	6	1.22
3006BB	9 oz, 4⅜" Diameter x 2½" Height, Rice Bowl	Dozen	50.26	1	24	3.70
1035BB	6 oz, 3⅝" x 3½" x 1⅞", Vegetable Dish	Dozen	41.40	2	16	2.07
3005BB	9 oz, 4¾" Diameter x 2" Height, Rice Bowl	Dozen	49.82	1	24	3.23
3540BB	8 oz, 4⅜" Diameter x 2⅞" Height, Saucer	Dozen	34.61	1	12	1.45
3008BB	6 oz, 3¾" Diameter x 2" Height, Rice Bowl	Dozen	42.99	2	24	1.79
1036BB	3 oz, 3⅝" Diameter x 1¾" Height, Dish	Dozen	27.46	2	24	1.14



3201BB (Bowl)
(Lid & Bowl are sold separately)



3201CBB (Lid)



3502BB



3503BB



3504BB



3506BB

Item	Description	U/M	Weight Gross lbs	Inner Pack	Master Pack	Cu. Ft.
3201BB	20 oz, 5¼" Diameter x 3" Height, Noodle Bowl (Lid Sold Separately)	Dozen	29.76	1	6	1.19
3201CBB	5¼" Diameter, Lid only for 3201BB	Dozen	14.33	1	6	0.97
3502BB	9 oz, 4" Diameter x 3⅞" Height, Miso Bowl with Lid	Dozen	25.93	0.50	6	1.34
3503BB	12 oz, 4⅞" Diameter x 2⅞" Height, Soup Bowl with Lid	Dozen	32.63	0.50	6	3.14
3504BB	14 oz, 4¼" Diameter x 3⅞" Height, Chawanmushi Bowl with Lid	Dozen	34.17	0.50	6	3.69
3506BB	10 oz, 4½" Diameter x 2¼" Height, Rice Bowl with Lid	Dozen	27.56	0.50	6	1.58



9152BB



9302BB



3545BB



3501BB



102.8BB



0002BB



1338BB



1002BB



0001BB

Item	Description	U/M	Weight Gross lbs	Inner Pack	Master Pack	Cu. Ft.
9152BB	5 oz, 3⅞" Diameter x 2⅞" Height, Tea Cup	Dozen	54.67	1	30	2.94
9302BB	11 oz, 3½" Diameter x 3⅞" Height, Tea Cup	Dozen	46.30	1	10	2.96
3545BB	6 oz, 4½" Diameter x 2¼" Height, Saucer	Dozen	32.41	1	12	1.32
3501BB	7 oz, 4 ½" Diameter x 2⅞" Height, Sauce Bowl	Dozen	28.44	1	12	1.37
102.8BB	2 oz, 3½" Diameter x ⅝" Height, Sauce Dish	Dozen	64.77	5	80	1.89
0002BB	1½ oz, 3⅞" x 2¾" x 1⅞", Divided Sauce Dish	Dozen	27.34	1	18	1.35
1338BB	3¾" Diameter x ½" Height, Saucer	Dozen	60.85	5	50	1.65
1002BB	4 oz, 3⅞" x 3⅞" x 1½", Square Bowl	Dozen	31.31	1	20	1.63
0001BB	2 oz, 3½" x 2⅞" x 1", Sauce Dish	Dozen	39.68	2	40	1.41

Blue Bamboo

MELAMINE



7001BB



7002BB



7003BB



7005BB



7006BB



7007BB



7008BB



7009BB

Item	Description	U/M	Weight Gross lbs	Inner Pack	Master Pack	Cu. Ft.
7001BB	1 oz, 7 ³ / ₈ " x 2 ¹ / ₂ ", Soup Ladle	Dozen	33.07	5	40	2.08
7002BB	1/2 oz, 4 ⁷ / ₈ " x 1 ⁵ / ₈ ", Soup Spoon	Dozen	60.63	5	100	1.99
7003BB	3/4 oz, 5 ³ / ₄ " x 1 ³ / ₄ ", Won Ton Soup Spoon	Dozen	52.58	5	100	2.26
7005BB	1 1/2 oz, 8 ¹ / ₄ " x 2 ³ / ₄ ", Rice Ladle	Dozen	48.50	2	30	2.38
7006BB	2 1/2 oz, 10 ¹ / ₄ " x 3 ³ / ₈ ", Soup Ladle	Dozen	41.89	2	30	3.85
7007BB	2 1/2 oz, 8 ³ / ₄ " x 2 ³ / ₄ ", Ladle/Spoon	Dozen	44.78	2	30	2.55
7008BB	1 1/2 oz, 9 ¹ / ₄ " x 3", Rice Ladle	Dozen	41.89	2	30	2.55
7009BB	12 ¹ / ₂ " x 2 ¹ / ₂ ", Spatula/Turner	Dozen	41.89	2	30	2.49



8004BB



8005BB



8006BB

Item	Description	U/M	Weight Gross lbs	Inner Pack	Master Pack	Cu. Ft.
8004BB	13 oz, 9 ¹ / ₂ " x 4 ¹ / ₂ " x 1 ³ / ₄ ", Sushi Boat	Dozen	17.11	0.50	4	1.70
8005BB	22 oz, 12" x 5 ¹ / ₂ " x 2 ¹ / ₈ ", Sushi Boat	Dozen	25.60	0.50	4	3.12
8006BB	54 oz, 16 ¹ / ₄ " x 7 ¹ / ₈ " x 2 ⁵ / ₈ ", Sushi Boat	Dozen	27.34	0.50	2	2.98

****Rice Ladle and Soup Spoon are not NSF Certified.****



Gold Orchid



Lotus Shape Plate • Wavy
Rectangular Plate • Mug • Soup
Bowl • Dish Saucer • Plates



Gold Orchid

MELAMINE



1806



1807



1808



1810



1812



1814



1816

Item	Description	U/M	Weight Gross lbs	Inner Pack	Master Pack	Cu. Ft.
1806	6" Diameter x 1" Height, Lotus Shape Plate	Dozen	31.79	1	6	0.96
1807	7¼" Diameter x 1¼" Height, Lotus Shape Plate	Dozen	34.96	0.50	4	1.39
1808	8¼" Diameter x 1⅜" Height, Lotus Shape Plate	Dozen	24.52	0.50	2	0.95
1810	10½" Diameter x 1½" Height, Lotus Shape Plate	Dozen	35.19	0.50	2	1.55
1812	12" Diameter x 1⅝" Height, Lotus Shape Plate	Dozen	36.42	0.50	2	1.81
1814	14" Diameter x 1¾" Height, Lotus Shape Plate	Dozen	25.04	0.25	1	1.79
1816	16" Diameter x 1⅞" Height, Lotus Shape Plate	Dozen	37.06	0.25	1	2.39



1707



1708



1710



1712

Item	Description	U/M	Weight Gross lbs	Inner Pack	Master Pack	Cu. Ft.
1707	7½" Diameter x 1⅝" Height, Round Plate	Dozen	35.91	0.50	4	1.47
1708	8¼" Diameter x 1¼" Height, Round Plate	Dozen	23.94	0.50	2	0.93
1710	10½" Diameter x 1⅜" Height, Round Plate	Dozen	33.31	0.50	2	1.43
1712	11¾" Diameter x 1½" Height, Round Plate	Dozen	39.44	0.50	2	1.77



2404



2406



2408



2412



2414



2416

Item	Description	U/M	Weight Gross lbs	Inner Pack	Master Pack	Cu. Ft.
2404	3 oz, 4" x 3¾" x 1⅛", Wavy Rectangular Sauce Dish	Dozen	34.24	1	12	0.90
2406	8 oz, 6¼" x 4¾" x 1⅛", Wavy Rectangular Plate	Dozen	33.33	1	6	0.89
2408	12 oz, 8½" x 5¾" x 1⅛", Wavy Rectangular Plate	Dozen	35.23	1	4	0.93
2412	11 ¼" x 7¼" x 1", Wavy Rectangular Plate	Dozen	26.50	0.50	3	1.48
2414	13½" x 9 ⅛" x 1⅜", Wavy Rectangular Plate	Dozen	40.34	0.50	3	2.40
2416	15½" x 10¾" x 1¾", Wavy Rectangular Plate	Dozen	46.19	0.50	2	2.86



3704



3706



3707



3708GD

Item	Description	U/M	Weight Gross lbs	Inner Pack	Master Pack	Cu. Ft.
3704	10 oz, 4½" Diameter x 2⅝" Height, Wavy Rice Bowl	Dozen	37.46	0.50	6	1.39
3706	12½ oz, 5" Diameter x 2⅝" Height, Wavy Rice Bowl	Dozen	37.10	0.50	5	1.57
3707	23 oz, 6½" Diameter x 2⅞" Height, Wavy Soup Bowl	Dozen	38.65	0.50	3	1.52
3708GD	38½ oz, 8" Diameter x 3⅞" Height, Wavy Soup Bowl	Dozen	33.84	0.50	2	1.87

Gold Orchid

MELAMINE



5705



5706



5707

Item	Description	U/M	Weight Gross lbs	Inner Pack	Master Pack	Cu. Ft.
5705	11 oz, 4¾" Diameter x 2⅜" Height, Rice Bowl	Dozen	19.40	1	5	0.89
5706	16 oz, 6" Diameter x 2¾" Height, Soup Bowl	Dozen	29.17	0.50	4	1.38
5707	30 oz, 7½" Diameter x 3¼" Height, Soup Bowl	Dozen	26.19	0.50	2	1.34



5770



5780



3705

Item	Description	U/M	Weight Gross lbs	Inner Pack	Master Pack	Cu. Ft.
5770	24 oz, 6¾" Diameter x 2⅝" Height, Soup Bowl	Dozen	28.04	0.50	4	1.72
5780	32 oz, 7½" Diameter x 3⅜" Height, Soup Bowl	Dozen	31.68	0.50	3	2.09
3705	7 oz, 4¾" Diameter x 1¾" Height, Wavy Rice Bowl	Dozen	23.88	1	6	0.88



1903GD



1904GD



6602GD

Item	Description	U/M	Weight Gross lbs	Inner Pack	Master Pack	Cu. Ft.
1903GD	3 oz, 3½" Diameter x 1" Height, Flat Base Bowl	Dozen	18.50	1	12	1.07
1904GD	6 oz, 4½" Diameter x 1½" Height, Flat Base Bowl	Dozen	34.83	1	12	1.65
6602GD	3 oz, 4" Diameter x 1" Height, Hexagon Shape, Round Base Dish	Dozen	21.41	1	8	1.15



3601



3703



9753GD



1704

Item	Description	U/M	Weight Gross lbs	Inner Pack	Master Pack	Cu. Ft.
3601	5 oz, 4 7/8" x 4 1/4" x 2 1/4", Dip Bowl	Dozen	21.45	1	8	0.98
3703	2 oz, 3 1/4" Diameter x 1 1/2" Height, Dish Saucer	Dozen	30.16	1	12	1.08
9753GD	8 oz, 3 1/8" Diameter x 3 1/2" Height, Mug	Dozen	20.39	1	6	0.99
1704	4" Diameter x 1/2" Height, Round Plate	Dozen	18.12	1	8	0.46



1901GD



9752



3955GD



7003GD

Item	Description	U/M	Weight Gross lbs	Inner Pack	Master Pack	Cu. Ft.
1901GD	2 oz, 3 3/4" x 2 1/2" x 1", Rectangular Sauce Dish	Dozen	20.52	1	12	0.68
9752	4 oz, 3 1/4" Diameter x 2 1/8" Height, Mug	Dozen	21.63	1	6	0.73
3955GD	9 oz, 5 1/2" Diameter x 1 3/8" Height, Flat Base Bowl	Dozen	27.14	1	6	0.97
7003GD	3/4 oz, 5 5/8" x 1 5/8", Spoon	Dozen	52.58	5	100	2.26



**** Soup Spoon is not NSF Certified**

Tenmoku

MELAMINE



Dip Bowl • Rectangular Plate •
Plate • Wavy Rice Bowl • Mug





Item	Description	U/M	Weight Gross lbs	Inner Pack	Master Pack	Cu. Ft.
1806TM	6" Diameter x 1" Height, Lotus Shape Plate	Dozen	31.79	1	6	0.96
1807TM	7¼" Diameter x 1¼" Height, Lotus Shape Plate	Dozen	34.96	0.50	4	1.39
1808TM	8¼" Diameter x 1¾" Height, Lotus Shape Plate	Dozen	24.52	0.50	2	0.95
1809TM	9¾" Diameter x 1¾" Height, Lotus Shape Plate	Dozen	27.95	0.50	2	1.10
1810TM	10½" Diameter x 1½" Height, Lotus Shape Plate	Dozen	35.19	0.50	2	1.55
1812TM	12" Diameter x 1½" Height, Lotus Shape Plate	Dozen	36.42	0.50	2	1.81
1814TM	14" Diameter x 1¾" Height, Lotus Shape Plate	Dozen	25.04	0.25	1	1.79
1816TM	16" Diameter x 1¾" Height, Lotus Shape Plate	Dozen	37.06	0.25	1	2.39

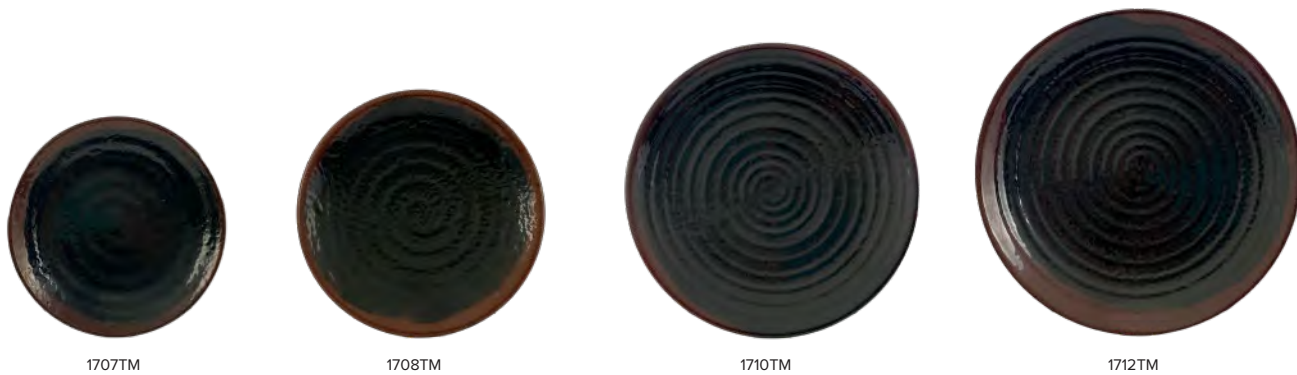

Item	Description	U/M	Weight Gross lbs	Inner Pack	Master Pack	Cu. Ft.
1707TM	7½" Diameter x 1½" Height, Round Plate	Dozen	35.91	0.50	4	1.47
1708TM	8¼" Diameter x 1¼" Height, Round Plate	Dozen	23.94	0.50	2	0.93
1710TM	10½" Diameter x 1¾" Height, Round Plate	Dozen	33.31	0.50	2	1.43
1712TM	11¾" Diameter x 1½" Height, Round Plate	Dozen	39.44	0.50	2	1.77

Tenmoku



2414TM



2416TM

Item	Description	U/M	Weight Gross lbs	Inner Pack	Master Pack	Cu. Ft.
2414TM	13½" x 9½" x 1⅜", Wavy Rectangular Plate	Dozen	40.34	0.50	3	2.40
2416TM	15½" x 10¾" x 1¾", Wavy Rectangular Plate	Dozen	46.19	0.50	2	2.86



2406TM



2408TM

Item	Description	U/M	Weight Gross lbs	Inner Pack	Master Pack	Cu. Ft.
2406TM	8 oz, 6¼" x 4¾" x 1⅛", Wavy Rectangular Plate	Dozen	33.33	1	6	0.89
2408TM	12 oz, 8½" x 5¾" x 1⅛", Wavy Rectangular Plate	Dozen	35.23	1	4	0.93



2411TM

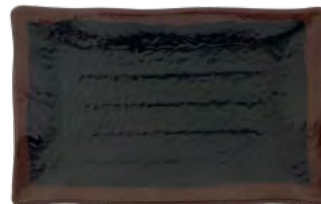

2412TM

Item	Description	U/M	Weight Gross lbs	Inner Pack	Master Pack	Cu. Ft.
2411TM	11¼" x 5" x 1", Rectangular Plate	Dozen	30.93	0.50	3	1.03
2412TM	11¼" x 7¼" x 1", Wavy Rectangular Plate	Dozen	26.50	0.50	3	1.48



3703TM



3704TM



3706TM



3707TM



3708TM

Item	Description	U/M	Weight Gross lbs	Inner Pack	Master Pack	Cu. Ft.
3703TM	2 oz, 3¼" Diameter x 1½" Height, Saucer Dish	Dozen	30.16	1	12	1.08
3704TM	10 oz, 4½" Diameter x 2⅝" Height, Wavy Rice Bowl	Dozen	37.46	0.50	6	1.39
3706TM	12½ oz, 5" Diameter x 2⅝" Height, Wavy Rice Bowl	Dozen	37.10	0.50	5	1.57
3707TM	23 oz, 6½" Diameter x 2⅝" Height, Wavy Soup Bowl	Dozen	38.65	0.50	3	1.52
3708TM	38½ oz, 8" Diameter x 3⅝" Height, Wavy Soup Bowl	Dozen	33.84	0.50	2	1.87



3705TM



5705TM



5706TM

Item	Description	U/M	Weight Gross lbs	Inner Pack	Master Pack	Cu. Ft.
3705TM	7 oz, 4¾" Diameter x 1¾" Height, Wavy Rice Bowl	Dozen	23.88	1	6	0.88
5705TM	11 oz, 4¾" Diameter x 2⅝" Height, Rice Bowl	Dozen	19.40	1	5	0.89
5706TM	16 oz, 6" Diameter x 2¾" Height, Soup Bowl	Dozen	29.17	0.50	4	1.38



5707TM



5770TM



5780TM



5765TM

Item	Description	U/M	Weight Gross lbs	Inner Pack	Master Pack	Cu. Ft.
5707TM	30 oz, 7½" Diameter x 3¼" Height, Soup Bowl	Dozen	26.19	0.50	2	1.34
5770TM	24 oz, 6¾" Diameter x 2⅝" Height, Soup Bowl	Dozen	28.04	0.50	4	1.72
5780TM	32 oz, 7½" Diameter x 3⅝" Height, Soup Bowl	Dozen	34.33	0.50	3	2.09
5765TM	32 oz, 6¾" Diameter x 3⅝" Height, Soup Bowl	Dozen	30.45	0.50	3	1.44

Tenmoku



3601TM • Dip Bowl
Enlarged to show detail



1903TM



1904TM



9752TM



9753TM



3601TM



3955TM

Item	Description	U/M	Weight Gross lbs	Inner Pack	Master Pack	Cu. Ft.
1903TM	3 oz, 3½" Diameter x 1" Height, Flat Base Bowl	Dozen	18.50	1	12	1.07
1904TM	6 oz, 4½" Diameter x 1½" Height, Flat Base Bowl	Dozen	34.83	1	12	1.65
9752TM	4 oz, 3¼" Diameter x 2½" Height, Mug	Dozen	21.63	1	6	0.73
9753TM	8 oz, 3½" Diameter x 3½" Height, Mug	Dozen	20.39	1	6	0.99
3601TM	5 oz, 4⅞" x 4¼" x 2¼", Dip Bowl	Dozen	21.45	1	8	0.98
3955TM	9 oz, 5½" Diameter x 1¾" Height, Flat Base Bowl	Dozen	27.14	1	6	0.97



2404TM • Wavy Sauce Dish
Enlarged to show detail



1901TM



1902TM



1703TM



1704TM



2404TM

Item	Description	U/M	Weight Gross lbs	Inner Pack	Master Pack	Cu. Ft.
1901TM	2 oz, 3¾" x 2½" x 1", Rectangular Sauce Dish	Dozen	20.52	1	12	0.68
1902TM	4 oz, 6" x 3" x ⅞", Twin Sauce Dish	Dozen	28.26	1	12	1.17
1703TM	2 oz, 3½" Diameter x ⅝" Height, Sauce Dish	Dozen	25.62	1	16	0.82
1704TM	4" Diameter x ½" Height, Round Plate	Dozen	18.12	1	8	0.46
2404TM	3 oz, 4" x 3¾" x 1½", Wavy Sauce Dish	Dozen	34.24	1	12	0.90

Two Tone



Rice Spoons • Sauce Dish • Miso
Soup Bowl • Lids • Soba Bowls



Two Tone



7003JBR • Rice Spoon
Enlarged to show detail



7003JBR



7200JBR



7100JBR

Item	Description	U/M	Weight Gross lbs	Inner Pack	Master Pack	Cu. Ft.
7003JBR	¾ oz, 5¾" x 1¾", Rice Spoon	Dozen	52.58	5	60	2.26
7100JBR	10 oz, 6¼" x 1¾", Soba Spoon	Dozen	45.48	5	60	2.21
7200JBR	0.6 oz, 6" x 1¾", Soup Spoon	Dozen	37.93	5	60	1.74



1101JBR



5560JBR



5565JBR



5570JBR



5560JBR • Donburi/ Soba Bowl
Enlarged to show detail



3221JBR



3222JBR



3223JBR



5185JBR

Item	Description	U/M	Weight Gross lbs	Inner Pack	Master Pack	Cu. Ft.
1101JBR	1 oz, 2¾" Diameter x ½" Height, Sauce Dish	Dozen	45.08	5	80	1.15
5560JBR	24 oz, 6 ⅛" Diameter x 3⅝" Height, Donburi/Soba Bowl	Dozen	32.67	1	6	1.70
5565JBR	28 oz, 6 ½" Diameter x 3¼" Height, Donburi/Soba Bowl	Dozen	38.06	1	6	1.95
5570JBR	38 oz, 7" Diameter x 3⅝" Height, Donburi/Soba Bowl	Dozen	43.74	1	6	2.30
3221JBR	8 oz, 4" Diameter x 2¾" Height (Lid: 3⅝" Diameter x 1¼" Height)	Dozen	26.82	1	6	1.50
3222JBR	10 oz, 4 ¾" Diameter x 2¼" Height (Lid: 4¼" Diameter x 1¼" Height)	Dozen	28.73	1	6	1.47
3223JBR	16 oz, 6" Diameter x 3" Height (Lid: 5½" Diameter 1½" Height)	Dozen	39.82	1	5	2.26
5185JBR	42 oz, 8½" Diameter x 3¼" Height, Soba Noodle Bowl	Dozen	39.60	1	4	3.14

** Spoons are not NSF Certified

Wei



Plates • Sauce Bowl • Noodle Bowl
• Sushi Boat • Soup Spoon



Wei

MELAMINE



Item	Description	U/M	Weight Gross lbs	Inner Pack	Master Pack	Cu. Ft.
1006J	6" Diameter x 1/2" Height, Round Plate	Dozen	60.63	1	24	1.96
1007J	6 7/8" Diameter x 3/4" Height, Round Plate	Dozen	46.03	1	16	1.69
1008J	7 7/8" Diameter x 5/8" Height, Round Plate	Dozen	55.12	1	12	1.86
1009J	9 1/8" Diameter x 3/4" Height, Round Plate	Dozen	49.71	1	8	1.66
1010J	10 3/8" Diameter x 7/8" Height, Round Plate	Dozen	39.48	1	6	1.69
1012J	11 3/4" Diameter x 7/8" Height, Round Plate	Dozen	44.25	1	4	1.62
1014J	14 1/8" Diameter x 1 1/8" Height, Round Plate	Dozen	51.81	0.50	3	2.22



Item	Description	U/M	Weight Gross lbs	Inner Pack	Master Pack	Cu. Ft.
1206J	6" Diameter x 3/4" Height, Curved Rim Plate	Dozen	47.40	1	18	1.63
1207J	7" Diameter x 1" Height, Curved Rim Plate	Dozen	60.19	1	16	2.20
1208J	8" Diameter x 1 1/8" Height, Curved Rim Plate	Dozen	55.56	1	12	2.19
1209J	9 1/4" Diameter x 1 1/8" Height, Curved Rim Plate	Dozen	52.47	1	8	2.17
1210J	10 1/2" Diameter x 1 3/8" Height, Curved Rim Plate	Dozen	50.71	1	6	2.33
1350J	5 1/8" Diameter x 1 1/8" Height, Soup Plate	Dozen	27.56	1	12	1.41
1360J	5 7/8" Diameter x 3/4" Height, Plate	Dozen	38.80	1	12	2.53
1365J	6 1/2" Diameter x 1 1/8" Height, Soup Plate	Dozen	40.12	1	12	2.15





Item	Description	U/M	Weight Gross lbs	Inner Pack	Master Pack	Cu. Ft.
1304J	4¾" Diameter x ⅝" Height, Dinner Plate	Dozen	36.16	1	24	1.42
1305J	5¼" Diameter x ¾" Height, Dinner Plate	Dozen	44.09	1	24	2.00
1306J	6⅝" Diameter x ¾" Height, Dinner Plate	Dozen	34.17	1	12	1.57
1307J	7⅜" Diameter x 1" Height, Dinner Plate	Dozen	31.53	1	8	1.47
1308J	8⅝" Diameter x 1⅝" Height, Dinner Plate	Dozen	24.25	1	4	1.13



Item	Description	U/M	Weight Gross lbs	Inner Pack	Master Pack	Cu. Ft.
2008J	8" x 6" x ⅝", Platter	Dozen	54.01	1	16	2.65
2009J	9" x 6⅝" x ¾", Platter	Dozen	41.23	1	10	1.84
2010J	9⅞" x 7¼" x ¾", Platter	Dozen	50.86	1	8	1.90
2012J	12" x 8⅝" x 7⁄8", Platter	Dozen	48.50	1	6	2.06

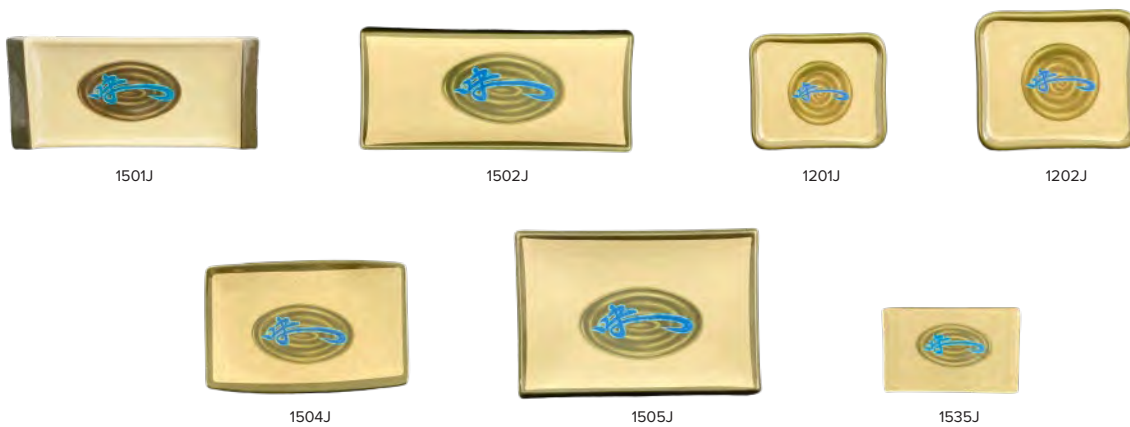

Item	Description	U/M	Weight Gross lbs	Inner Pack	Master Pack	Cu. Ft.
1501J	8½" x 3¾" x 1", Vegetable Serving Plate	Dozen	28.66	1	6	1.06
1502J	9⅝" x 4¼" x 1", Rectangular Barbecue Plate	Dozen	68.56	1	12	3.01
1201J	4¾" x 4¼" x 1⅝", Plate	Dozen	29.83	1	12	0.89
1202J	5½" x 4¾" x ¾", Plate	Dozen	37.43	1	12	1.30
1504J	6¾" x 4½" x 1⅝", Barbecue Plate	Dozen	39.68	1	12	1.86
1505J	8¼" x 5⅝" x 1", Barbecue Plate	Dozen	48.50	1	8	2.09
1535J	5¼" x 3¾" x ¾", Plate	Dozen	31.53	1	12	1.24

Wei



0011J



0900J



1203J



0010J



1607J



1608J



1609J



1503J

Item	Description	U/M	Weight Gross lbs	Inner Pack	Master Pack	Cu. Ft.
0011J	8½" x 4¾" x 1⅛", Bamboo Sashimi Platter	Dozen	37.63	1	6	1.88
0900J	13½" x 4½" x ⅝", Sandwich Tray	Dozen	53.57	1	8	2.24
1203J	6" x 5½" x ¾", Oblong Platter	Dozen	36.38	1	12	1.26
0010J	6½" x 5½" x 1⅛", Plate	Dozen	35.71	1	6	1.19
1607J	2 oz, 4" x 2¾" x ⅞", Wavy Shape Sauce Dish	Dozen	33.29	1	24	1.35
1608J	5¾" x 4" x ¾", Wavy Shape Barbecue Plate	Dozen	31.08	1	12	1.18
1609J	8½" x 5½" x ⅞", Wavy Shape Barbecue Plate	Dozen	28.66	1	6	1.15
1503J	6¾" x 4½" x 1", Bamboo Plate	Dozen	44.09	1	12	1.87



2308



2309



2311



0901J



0902J



0903J

Item	Description	U/M	Weight Gross lbs	Inner Pack	Master Pack	Cu. Ft.
2308	8" x 5¾" x ¾", Teriyaki Tray	Dozen	22.22	1	6	0.75
2309	9" x 6½" x ⅞", Teriyaki Tray	Dozen	32.23	1	6	1.00
2311	23 oz, 10¾" x 7⅞" x 1", Teriyaki Tray	Dozen	33.05	1	4	1.06
0901J	13⅞" x 10¼" x ¾", Tray	Dozen	19.00	0.50	2	0.96
0902J	15¼" x 11½" x ⅞", Tray	Dozen	24.54	0.50	2	1.34
0903J	17" x 12⅝" x 1", Tray	Dozen	33.16	0.50	2	1.69



5060J



5065J



5070J



5075J



5085J



5095J

Item	Description	U/M	Weight Gross lbs	Inner Pack	Master Pack	Cu. Ft.
5060J	22 oz, 6 ⁷ / ₈ " Diameter x 2 ¹ / ₄ " Height, Rimless Bowl	Dozen	37.92	1	8	2.07
5065J	32 oz, 7 ¹ / ₂ " Diameter x 2 ¹ / ₂ " Height, Rimless Bowl	Dozen	43.98	1	8	2.59
5070J	36 oz, 8" Diameter x 2 ⁵ / ₈ " Height, Rimless Bowl	Dozen	41.45	1	6	2.10
5075J	52 oz, 8 ³ / ₄ " Diameter x 2 ⁷ / ₈ " Height, Rimless Bowl	Dozen	47.18	1	6	2.43
5085J	70 oz, 9 ³ / ₄ " Diameter x 3 ¹ / ₄ " Height, Rimless Bowl	Dozen	48.06	0.50	4	3.24
5095J	96 oz, 11" Diameter x 3 ³ / ₄ " Height, Rimless Bowl	Dozen	51.15	0.50	3	3.66



5206J



5207J



5208J



5306J



5307J



5308J



5309J

Item	Description	U/M	Weight Gross lbs	Inner Pack	Master Pack	Cu. Ft.
5206J	25 oz, 5 ⁷ / ₈ " Diameter x 2 ⁷ / ₈ " Height, Rice Bowl	Dozen	26.46	1	6	1.35
5207J	39 oz, 7" Diameter x 3 ¹ / ₄ " Height, Rice Bowl	Dozen	37.15	1	6	2.11
5208J	56 oz, 8" Diameter x 3 ¹ / ₂ " Height, Rice Bowl	Dozen	41.29	1	6	2.50
5306J	21 oz, 6" Diameter x 2 ¹ / ₂ " Height, Swirl Bowl	Dozen	29.10	1	6	1.29
5307J	32 oz, 6 ⁷ / ₈ " Diameter x 2 ³ / ₄ " Height, Swirl Bowl	Dozen	37.48	1	6	1.58
5308J	48 oz, 8" Diameter x 3 ¹ / ₈ " Height, Swirl Bowl	Dozen	51.15	0.50	6	2.94
5309J	72 oz, 9" Diameter x 3 ¹ / ₂ " Height, Swirl Bowl	Dozen	37.92	0.50	3	2.16

Wei



5265J



5275J



5285J



5106J



5107J



5108J



5008J

Item	Description	U/M	Weight Gross lbs	Inner Pack	Master Pack	Cu. Ft.
5265J	25 oz, 6¼" Diameter x 2¾" Height, Scalloped Bowl	Dozen	39.68	1	8	1.92
5275J	34 oz, 7¼" Diameter x 3" Height, Scalloped Bowl	Dozen	40.79	1	6	1.82
5285J	53 oz, 8¼" Diameter x 3½" Height, Scalloped Bowl	Dozen	60.63	0.50	6	3.60
5106J	15 oz, 6" Diameter x 2⅝" Height, Bowl	Dozen	39.24	1	12	1.76
5107J	24 oz, 7" Diameter x 2¼" Height, Bowl	Dozen	39.68	1	8	1.46
5108J	34 oz, 8" Diameter x 2½" Height, Bowl	Dozen	50.71	1	8	2.47
5008J	35 oz, 8" Diameter x 2⅝" Height, Special Deep Bowl	Dozen	41.89	1	6	2.27



3504J



3506J



3502J



3201J (Bowl)
(Lid & Bowl are sold separately)



3201CJ



3503J



3540J

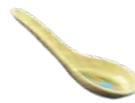

7002J



7003J



7100J

Item	Description	U/M	Weight Gross lbs	Inner Pack	Master Pack	Cu. Ft.
3504J	14 oz, 4¼" Diameter x 3⅝" Height, Chawanmushi Bowl with Lid	Dozen	34.17	0.50	6	3.69
3506J	10 oz, 4½" Diameter x 2¼" Height, Rice Bowl with Lid	Dozen	27.56	0.50	6	1.58
3502J	9 oz, 4" Diameter x 3⅞" Height, Miso Bowl with Lid	Dozen	25.93	0.50	6	1.34
3201J	20 oz, 5¾" Diameter x 3" Height, Noodle Bowl (Lid Sold Separately)	Dozen	29.76	1	6	1.19
3201CJ	5¼" Diameter, Lid Only for 3201J	Dozen	14.33	1	6	0.97
3503J	12 oz, 4⅞" Diameter x 2⅞" Height, Soup Bowl with Lid	Dozen	32.63	0.50	6	3.14
3540J	8 oz, 4⅜" Diameter x 2⅞" Height, Saucer	Dozen	34.61	1	12	1.45
7002J	½ oz, 4⅞" x 1⅝", Soup Spoon	Dozen	60.63	5	100	1.99
7003J	¾ oz, 5¾" x 1¾", Won Ton Soup Spoon	Dozen	52.58	5	100	2.26
7100J	1 oz, 6¼" x 1¾", Soup Spoon	Dozen	45.48	5	60	2.21

****Soup Spoon are not NSF Certified.****





3001J



3005J



3006J



3008J

Item	Description	U/M	Weight Gross lbs	Inner Pack	Master Pack	Cu. Ft.
3001J	10 oz, 4½" Diameter x 1¾" Height, Bowl	Dozen	20.28	0.50	6	1.22
3005J	9 oz, 4¾" Diameter x 2" Height, Rice Bowl	Dozen	49.82	1	24	3.23
3006J	9 oz, 4¾" Diameter x 2½" Height, Rice Bowl	Dozen	50.26	1	24	3.70
3008J	6 oz, 3¾" Diameter x 2" Height, Rice Bowl	Dozen	42.99	2	24	1.79



0002J



1035J



1036J



9152J



9302J



0001J



1002J



1338J



1338J



3545J



3501J

Item	Description	U/M	Weight Gross lbs	Inner Pack	Master Pack	Cu. Ft.
0002J	1½ oz, 3⅝" x 2¾" x 1⅛", Divided Sauce Dish	Dozen	27.34	1	18	1.35
1035J	6 oz, 3⅝" x 3½" x 1⅞", Vegetable Dish	Dozen	41.40	2	16	2.07
1036J	3 oz, 3⅝" Diameter x 1¾" Height, Dish	Dozen	27.46	2	24	1.14
9152J	5 oz, 3⅝" Diameter x 2½" Height, Tea Cup	Dozen	54.67	1	30	2.94
9302J	11 oz, 3½" Diameter x 3⅝" Height, Tea Cup	Dozen	46.30	1	10	2.96
0001J	2 oz, 3½" x 2⅝" x 1", Sauce Dish	Dozen	39.68	2	40	1.41
1002J	4 oz, 3⅝" x 3⅝" x 1½", Square Bowl	Dozen	31.31	1	20	1.63
102.8J	2 oz, 3½" Diameter x ⅜" Height, Sauce Dish	Dozen	64.77	5	80	1.89
1338J	3¾" Diameter x ½" Height, Saucer	Dozen	60.85	5	50	1.65
3545J	6 oz, 4½" Diameter x 2¼" Height, Saucer	Dozen	32.41	1	12	1.32
3501J	7 oz, 4½" Diameter x 2½" Height, Sauce Bowl	Dozen	28.44	1	12	1.37



8004J



8005J



8006J

Item	Description	U/M	Weight Gross lbs	Inner Pack	Master Pack	Cu. Ft.
8004J	13 oz, 9½" x 4½" x 1¾", Sushi Boat	Dozen	17.11	0.50	4	1.70
8005J	22 oz, 12" x 5½" x 2½", Sushi Boat	Dozen	25.60	0.50	4	3.12
8006J	54 oz, 16¼" x 7⅞" x 2⅝", Sushi Boat	Dozen	27.34	0.50	2	2.98

Blue Jade

MELAMINE



Plates • Platter • Flat Bowl
Sauce Dish • Mug



Blue Jade

2024



Item	Description	U/M	Weight Gross lbs	Inner Pack	Master Pack	Cu. Ft.
1907	7 $\frac{1}{8}$ " Diameter x 1" Height, Round Plate	Dozen	31.08	1	6	1.24
1908	8 $\frac{7}{8}$ " Diameter x 1 $\frac{1}{4}$ " Height, Round Plate	Dozen	37.35	0.50	4	1.87
1909	9 $\frac{1}{4}$ " Diameter x 1 $\frac{1}{4}$ " Height, Round Plate	Dozen	35.63	1	4	1.42
1910	9 $\frac{3}{4}$ " Diameter x 1 $\frac{3}{8}$ " Height, Round Plate	Dozen	37.24	0.50	3	1.83
1911	10 $\frac{3}{4}$ " Diameter x 1 $\frac{5}{8}$ " Height, Round Plate	Dozen	29.61	0.50	2	1.38
1912	12" Diameter x 1 $\frac{3}{8}$ " Height, Round Plate	Dozen	30.38	1	2	1.28
1913	13" Diameter x 1 $\frac{3}{4}$ " Height, Round Plate	Dozen	37.06	0.50	2	2.06
1914	13 $\frac{3}{4}$ " Diameter x 1 $\frac{3}{8}$ " Height, Round Plate	Dozen	39.37	0.50	2	2.08
1916	15 $\frac{3}{4}$ " Diameter x 1 $\frac{7}{8}$ " Height, Round Plate	Dozen	36.49	0.25	1	2.31
1915	14" Diameter x 1 $\frac{3}{4}$ " Height, Narrow Rim Round Plate	Dozen	26.76	0.50	1	1.39

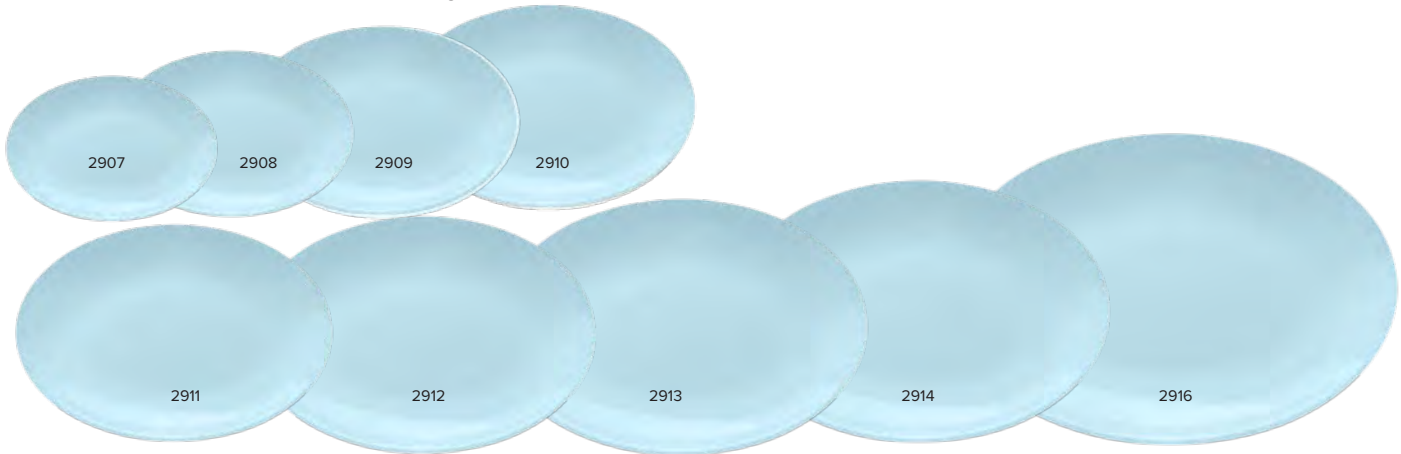

Item	Description	U/M	Weight Gross lbs	Inner Pack	Master Pack	Cu. Ft.
2907	7 $\frac{1}{8}$ " x 5" x $\frac{3}{4}$ ", Platter	Dozen	30.98	1	8	0.92
2908	8 $\frac{1}{8}$ " x 5 $\frac{3}{8}$ " x $\frac{3}{4}$ ", Platter	Dozen	25.33	1	6	0.89
2909	9 $\frac{1}{4}$ " x 6 $\frac{3}{4}$ " x $\frac{7}{8}$ ", Platter	Dozen	32.12	1	6	1.10
2910	10 $\frac{1}{4}$ " x 7 $\frac{1}{2}$ " x $\frac{7}{8}$ ", Platter	Dozen	30.80	1	4	1.06
2911	11 $\frac{1}{4}$ " x 8 $\frac{3}{8}$ " x $\frac{7}{8}$ ", Platter	Dozen	31.44	0.50	3	1.17
2912	12 $\frac{1}{2}$ " x 9 $\frac{1}{4}$ " x 1 $\frac{1}{8}$ ", Platter	Dozen	39.88	1	4	1.69
2913	13" x 9 $\frac{1}{2}$ " x 1 $\frac{1}{8}$ ", Platter	Dozen	27.07	0.50	2	1.19
2914	13 $\frac{1}{8}$ " x 10 $\frac{3}{8}$ " x 1 $\frac{1}{8}$ ", Platter	Dozen	28.33	0.50	2	1.35
2916	16" x 11 $\frac{1}{4}$ " x 1 $\frac{1}{4}$ ", Platter	Dozen	44.62	0.50	2	1.82

MELAMINE

167

Blue Jade

MELAMINE



5975



5980



5990



3945



3955



3960



3965



1960

Item	Description	U/M	Weight Gross lbs	Inner Pack	Master Pack	Cu. Ft.
5975	42 oz, 7½" Diameter x 2⅞" Height, Bowl	Dozen	32.85	0.50	3	1.92
5980	54 oz, 8¼" Diameter x 3⅜" Height, Soup Bowl	Dozen	38.60	0.50	3	2.39
5990	74 oz, 9¼" Diameter x 3⅜" Height, Soup Bowl	Dozen	46.43	0.50	3	3.19
3945	6 oz, 4½" Diameter x 1¼" Height, Sauce Dish	Dozen	22.31	1	8	0.83
3955	9 oz, 5½" Diameter x 1⅜" Height, Bowl	Dozen	26.17	1	6	0.97
3960	12 oz, 6" Diameter x 1⅜" Height, Bowl	Dozen	21.32	1	4	0.88
3965	15 oz, 6½" Diameter x 1½" Height, Bowl	Dozen	26.28	0.50	4	1.19
1960	19 oz, 5¾" Diameter x 2" Height, Bowl	Dozen	20.61	0.50	4	1.66



3904



3905



3906



3935



5904



9154



9952



1903



1904



1905



1906



1945



1901



1902



1940

Item	Description	U/M	Weight Gross lbs	Inner Pack	Master Pack	Cu. Ft.
3904	8 oz, 4½" Diameter x 1⅞" Height, Bowl	Dozen	30.23	1	8	1.32
3905	12 oz, 5" Diameter x 2" Height, Bowl	Dozen	34.99	1	8	1.62
3906	18 oz, 6" Diameter x 2⅞" Height, Bowl	Dozen	26.41	0.50	4	1.36
3935	3 oz, 3¾" Diameter x 1⅞" Height, Sauce Dish	Dozen	22.05	2	12	0.79
5904	7 oz, 4" Diameter x 1⅞" Height, Bowl	Dozen	25.49	1	8	0.95
9154	8 oz, 3⅞" Diameter x 3⅞" Height, Tea Cup	Dozen	38.28	1	10	3.01
9952	9 oz, 2⅞" Diameter x 3¼" Height, Mug	Dozen	23.41	1	8	1.89
1903	3 oz, 3½" Diameter x 1" Height, Flat Base Bowl	Dozen	18.50	1	12	1.07
1904	6 oz, 4½" Diameter x 1⅞" Height, Flat Base Bowl	Dozen	34.83	1	12	1.58
1905	8 oz, 5½" Diameter x 1¼" Height, Flat Base Bowl	Dozen	45.77	1	12	2.53
1906	14 oz, 6" Diameter x 1⅜" Height, Flat Base Bowl	Dozen	18.58	1	4	1.15
1945	10 oz, 4½" Diameter x 2⅞" Height, Bowl	Dozen	34.13	1	12	1.42
1901	2 oz, 3¾" x 2½" x 1", Sauce Dish	Dozen	20.52	1	12	0.68
1902	4 oz, 6" x 3" x ⅞", Twin Sauce Dish	Dozen	28.26	1	12	1.17
1940	7 oz, 4" Diameter x 1⅞" Height, Sauce Dish	Dozen	19.62	1	6	1.14



Ramekin



Salsa Dishes • Fluted Ramekins •
Smooth Ramekins



MELAMINE RAMEKINS, BONE

Ramekins are perfect for containing dipping sauces, small appetizers, and any small side dishes to accompany a meal.

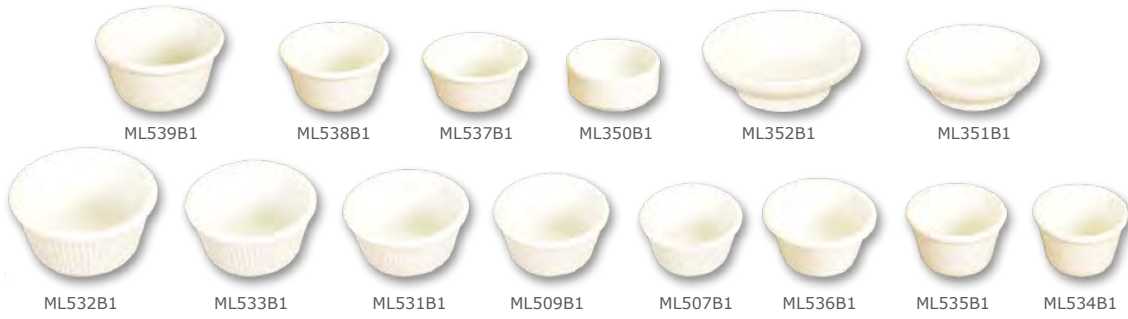

ITEM	DESCRIPTION	U/M	WEIGHT GROSS lbs	INNER PACK	MASTER PACK	CU. FT.
ML350B1	2 oz, 2 ⁷ / ₈ " Smooth Ramekin (Heavy Duty), Bone	DOZEN	49.19	1	24	2.50
ML351B1	4 ¹ / ₂ oz, 4" Salsa Dish, Bone	DOZEN	23.10	1	12	1.08
ML352B1	8 oz, 4 ³ / ₄ " Salsa Dish, Bone	DOZEN	28.97	1	12	1.43
ML507B1	1 ¹ / ₂ oz, 2 ¹ / ₂ " Fluted Ramekin, Bone	DOZEN	55.26	1	48	2.81
ML509B1	2 oz, 2 ⁷ / ₈ " Fluted Ramekin, Bone	DOZEN	70.44	1	48	3.64
ML531B1	3 oz, 3 ¹ / ₈ " Fluted Ramekin, Bone	DOZEN	44.88	1	24	2.19
ML532B1	4 oz, 3 ³ / ₈ " Fluted Ramekin, Bone	DOZEN	54.19	1	24	2.73
ML533B1	3 ¹ / ₂ oz, 3 ³ / ₈ " Fluted Ramekin, Bone	DOZEN	48.55	1	24	1.29
ML534B1	1 ¹ / ₂ oz, 2 ¹ / ₂ " Smooth Ramekin, Bone	DOZEN	32.43	1	24	1.80
ML535B1	1 ³ / ₄ oz, 2 ¹ / ₂ " Smooth Ramekin, Bone	DOZEN	48.03	1	48	2.35
ML536B1	2 ¹ / ₂ oz, 2 ⁷ / ₈ " Smooth Ramekin, Bone	DOZEN	48.05	1	48	2.05
ML537B1	3 oz, 3 ¹ / ₈ " Smooth Ramekin, Bone	DOZEN	42.61	1	24	1.96
ML538B1	4 oz, 3 ³ / ₈ " Smooth Ramekin, Bone	DOZEN	50.71	1	24	2.49
ML539B1	6 oz, 3 ⁷ / ₈ " Smooth Ramekin, Bone	DOZEN	64.40	1	24	2.80

MELAMINE RAMEKINS, WHITE

Ramekins are perfect for containing dipping sauces, small appetizers, and any small side dishes to accompany a meal.



ITEM	DESCRIPTION	U/M	WEIGHT GROSS lbs	INNER PACK	MASTER PACK	CU. FT.
ML351W1	4 ¹ / ₂ oz, 4 ¹ / ₈ " Salsa Dish White	DOZEN	23.10	1	12	1.08
ML352W1	8 oz, 4 ³ / ₄ " Salsa Bowl White	DOZEN	28.97	1	12	1.43
ML507W1	1 ¹ / ₂ oz, 2 ¹ / ₂ " Fluted Ramekin, White	DOZEN	55.26	1	48	2.81
ML509W1	2 oz, 2 ⁷ / ₈ " Fluted Ramekin, White	DOZEN	70.44	1	48	3.64
ML531W1	3 oz, 3 ¹ / ₈ " Fluted Ramekin, White	DOZEN	44.88	1	24	2.19
ML532W1	4 oz, 3 ³ / ₈ " Fluted Ramekin, White	DOZEN	54.19	1	24	2.73
ML533W1	3 oz, 3 ³ / ₈ " Fluted Ramekin White	DOZEN	48.55	1	24	1.29
ML534W1	1 ¹ / ₂ oz, 2 ¹ / ₂ " Smooth Ramekin, White	DOZEN	32.43	1	24	1.80
ML535W1	1 ³ / ₄ oz, 2 ¹ / ₂ " Smooth Ramekin, White	DOZEN	48.03	1	48	2.35
ML536W1	2 oz, 2 ⁷ / ₈ " Smooth Ramekin White	DOZEN	48.05	1	48	2.05
ML537W1	3 oz, 3 ¹ / ₈ " Smooth Ramekin, White	DOZEN	42.61	1	24	1.96
ML538W1	4 oz, 3 ³ / ₈ " Smooth Ramekin, White	DOZEN	50.71	1	24	2.49
ML539W1	6 oz, 3 ⁷ / ₈ " Smooth Ramekin, White	DOZEN	64.40	1	24	2.80



MELAMINE RAMEKINS, CHOCOLATE

Ramekins are perfect for containing dipping sauces, small appetizers, and any small side dishes to accompany a meal.



ITEM	DESCRIPTION	U/M	WEIGHT GROSS lbs	INNER PACK	MASTER PACK	CU. FT.
ML351C1	4½ oz, 4" Salsa Dish, Chocolate	DOZEN	23.10	1	12	1.08
ML352C1	8 oz, 4¾" Salsa Dish, Chocolate	DOZEN	28.97	1	12	1.43
ML507C1	1½ oz, 2½" Fluted Ramekin, Chocolate	DOZEN	55.26	1	48	2.81
ML509C1	2 oz, 2⅞" Fluted Ramekin, Chocolate	DOZEN	70.44	1	48	3.64
ML531C1	3 oz, 3⅞" Fluted Ramekin, Chocolate	DOZEN	44.88	1	24	2.19
ML532C1	4 oz, 3⅞" Fluted Ramekin, Chocolate	DOZEN	54.19	1	24	2.73
ML533C1	3½ oz, 3⅞" Fluted Ramekin, Chocolate	DOZEN	48.55	1	24	1.29
ML534C1	1½ oz, 2½" Smooth Ramekin, Chocolate	DOZEN	32.43	1	24	1.80
ML535C1	1¾ oz, 2½" Smooth Ramekin, Chocolate	DOZEN	48.03	1	48	2.35
ML536C1	2½ oz, 2⅞" Smooth Ramekin, Chocolate	DOZEN	48.05	1	48	2.05
ML537C1	3 oz, 3⅞" Smooth Ramekin, Chocolate	DOZEN	42.61	1	24	1.96
ML538C1	4 oz, 3⅞" Smooth Ramekin, Chocolate	DOZEN	50.71	1	24	2.49
ML539C1	6 oz, 3⅞" Smooth Ramekin, Chocolate	DOZEN	64.40	1	24	2.80

MELAMINE RAMEKINS, COBALT BLUE

Ramekins are perfect for containing dipping sauces, small appetizers, and any small side dishes to accompany a meal.



ITEM	DESCRIPTION	U/M	WEIGHT GROSS lbs	INNER PACK	MASTER PACK	CU. FT.
ML351CB1	4½ oz, 4" Salsa Dish, Cobalt Blue	DOZEN	23.10	1	12	1.08
ML352CB1	8 oz, 4¾" Salsa Dish, Cobalt Blue	DOZEN	28.97	1	12	1.43
ML507CB1	1½ oz, 2½" Fluted Ramekin, Cobalt Blue	DOZEN	55.26	1	48	2.81
ML509CB1	2 oz, 2⅞" Fluted Ramekin, Cobalt Blue	DOZEN	70.44	1	48	3.64
ML531CB1	3 oz, 3⅞" Fluted Ramekin, Cobalt Blue	DOZEN	44.88	1	24	2.19
ML532CB1	4 oz, 3⅞" Fluted Ramekin, Cobalt Blue	DOZEN	54.19	1	24	2.73
ML533CB1	3½ oz, 3⅞" Fluted Ramekin, Cobalt Blue	DOZEN	48.55	1	24	1.29
ML534CB1	1½ oz, 2½" Smooth Ramekin, Cobalt Blue	DOZEN	32.43	1	24	1.80
ML535CB1	1¾ oz, 2½" Smooth Ramekin, Cobalt Blue	DOZEN	48.03	1	48	2.35
ML536CB1	2½ oz, 2⅞" Smooth Ramekin, Cobalt Blue	DOZEN	48.05	1	48	2.05
ML537CB1	3 oz, 3⅞" Smooth Ramekin, Cobalt Blue	DOZEN	42.61	1	24	1.96
ML538CB1	4 oz, 3⅞" Smooth Ramekin, Cobalt Blue	DOZEN	50.71	1	24	2.49
ML539CB1	6 oz, 3⅞" Smooth Ramekin, Cobalt Blue	DOZEN	64.40	1	24	2.80

MELAMINE RAMEKINS, BLACK

Ramekins are perfect for containing dipping sauces, small appetizers, and any small side dishes to accompany a meal.



ITEM	DESCRIPTION	U/M	WEIGHT GROSS lbs	INNER PACK	MASTER PACK	CU. FT.
ML351BL1	4½ oz, 4" Salsa Dish, Black	DOZEN	23.10	1	12	1.08
ML352BL1	8 oz, 4¾" Salsa Dish, Black	DOZEN	28.97	1	12	1.43
ML507BL1	1½ oz, 2½" Fluted Ramekin, Black	DOZEN	55.26	1	48	2.81
ML509BL1	2 oz, 2⅞" Fluted Ramekin, Black	DOZEN	70.44	1	48	3.64
ML531BL1	3 oz, 3⅝" Fluted Ramekin, Black	DOZEN	44.88	1	24	2.19
ML532BL1	4 oz, 3⅞" Fluted Ramekin, Black	DOZEN	54.19	1	24	2.73
ML533BL1	3½ oz, 3⅞" Fluted Ramekin, Black	DOZEN	48.55	1	24	1.29
ML534BL1	1½ oz, 2½" Smooth Ramekin, Black	DOZEN	32.43	1	24	1.80
ML535BL1	1¾ oz, 2½" Smooth Ramekin, Black	DOZEN	48.03	1	48	2.35
ML536BL1	2½ oz, 2⅞" Smooth Ramekin, Black	DOZEN	48.05	1	48	2.05
ML537BL1	3 oz, 3⅝" Smooth Ramekin, Black	DOZEN	42.61	1	24	1.96
ML538BL1	4 oz, ¾" Smooth Ramekin, Black	DOZEN	50.71	1	24	2.49
ML539BL1	6 oz, 3⅞" Smooth Ramekin, Black	DOZEN	64.40	1	24	2.80

PLASTIC RAMEKINS, BLACK

Ramekins are perfect for containing dipping sauces, small appetizers, and any small side dishes to accompany a meal.



ITEM	DESCRIPTION	U/M	WEIGHT GROSS lbs	INNER PACK	MASTER PACK	CU. FT.
PL351BL1	4½ oz, 4" Salsa Dish, Black	DOZEN	20.61	1	12	1.11
PL352BL1	8 oz, 4¾" Salsa Dish, Black	DOZEN	26.54	1	12	1.68
PL507BL1	1½ oz, 2½" Fluted Ramekin, Black	DOZEN	47.50	1	48	3.20
PL509BL1	2 oz, 2⅞" Fluted Ramekin, Black	DOZEN	53.23	1	48	2.68
PL531BL1	3 oz, 3⅝" Fluted Ramekin, Black	DOZEN	37.57	1	24	1.83
PL532BL1	4 oz, 3⅞" Fluted Ramekin, Black	DOZEN	43.36	1	24	1.68
PL533BL1	3½ oz, 3⅞" Fluted Ramekin, Black	DOZEN	39.48	1	24	2.14
PL534BL1	1½ oz, 2½" Smooth Ramekin, Black	DOZEN	31.94	1	24	1.94
PL535BL1	1¾ oz, 2½" Smooth Ramekin, Black	DOZEN	45.22	1	48	2.88
PL536BL1	2½ oz, 2⅞" Smooth Ramekin, Black	DOZEN	47.32	1	48	2.35
PL537BL1	3 oz, 3⅝" Smooth Ramekin, Black	DOZEN	35.61	1	24	1.83
PL538BL1	4 oz, ¾" Smooth Ramekin, Black	DOZEN	45.74	1	24	2.13
PL539BL1	6 oz, 3⅞" Smooth Ramekin, Black	DOZEN	46.39	1	24	2.10



MELAMINE RAMEKIN RETAIL PACKS, BONE

Ramekins are perfect for containing dipping sauces, small appetizers, and any small side dishes to accompany a meal.



ITEM	DESCRIPTION	U/M	WEIGHT GROSS lbs	INNER PACK	MASTER PACK	CU. FT.
ML507B1R	1 1/2 oz, 2 1/2" Fluted Ramekin, Bone-Retail Pack	PACK OF 12	17.66	1	12	0.95
ML509B1R	2 oz, 2 7/8" Fluted Ramekin, Bone-Retail Pack	PACK OF 12	21.16	1	12	1.26
ML531B1R	3 oz, 3/8" Fluted Ramekin, Bone-Retail Pack	PACK OF 12	25.92	1	12	1.57
ML532B1R	4 oz, 3 3/8" Fluted Ramekin, Bone-Retail Pack	PACK OF 12	29.41	1	12	2.00
ML535B1R	1 3/4 oz, 2 1/2" Smooth Ramekin, Bone-Retail Pack	PACK OF 12	16.08	1	12	1.00
ML536B1R	2 1/2 oz, 2 7/8" Smooth Ramekin, Bone-Retail Pack	PACK OF 12	18.30	1	12	1.17
ML537B1R	3 oz, 3 1/8" Smooth Ramekin, Bone-Retail Pack	PACK OF 12	24.65	1	12	1.62
ML538B1R	4 oz, 3 3/8" Smooth Ramekin, Bone-Retail Pack	PACK OF 12	27.82	1	12	1.95



MELAMINE RAMEKIN RETAIL PACKS, WHITE

Ramekins are perfect for containing dipping sauces, small appetizers, and any small side dishes to accompany a meal.



ITEM	DESCRIPTION	U/M	WEIGHT GROSS lbs	INNER PACK	MASTER PACK	CU. FT.
ML507W1R	1 1/2 oz, 2 1/2" Fluted Ramekin, White-Retail Pack	PACK OF 12	17.66	1	12	0.95
ML509W1R	2 oz, 2 7/8" Fluted Ramekin, White-Retail Pack	PACK OF 12	21.16	1	12	1.26
ML531W1R	3 oz, 3 1/8" Fluted Ramekin, White-Retail Pack	PACK OF 12	25.92	1	12	1.57
ML532W1R	4 oz, 3 3/8" Fluted Ramekin, White-Retail Pack	PACK OF 12	29.41	1	12	2.00
ML535W1R	1 3/4 oz, 2 1/2" Smooth Ramekin, White-Retail Pack	PACK OF 12	16.08	1	12	1.00
ML536W1R	2 1/2 oz, 2 7/8" Smooth Ramekin, White-Retail Pack	PACK OF 12	18.30	1	12	1.17
ML537W1R	3 oz, 3 1/8" Smooth Ramekin, White-Retail Pack	PACK OF 12	24.65	1	12	1.62
ML538W1R	4 oz, 3 3/8" Smooth Ramekin, White-Retail Pack	PACK OF 12	27.82	1	12	1.95



Serving Utensil

Available in slotted, and solid style, these utensils provide a touch of color and accents to food service.



MELAMINE

Thailand



Item	Description	U/M	Weight Gross lbs	Inner Pack	Master Pack	Cu. Ft.
7001TL	1 oz, 7 ³ / ₈ " x 2 ¹ / ₂ ", Soup Ladle	Dozen	33.07	5	40	2.08
7005TL	1 ¹ / ₂ oz, 8 ¹ / ₄ " x 2 ³ / ₄ ", Rice Ladle	Dozen	48.50	2	30	2.38
7006TL	2 ¹ / ₂ oz, 10 ¹ / ₄ " x 3 ³ / ₈ ", Soup Ladle	Dozen	41.89	2	30	3.85
7007TL	2 ¹ / ₂ oz, 8 ⁷ / ₈ " x 2 ³ / ₄ ", Ladle/Spoon	Dozen	44.78	2	30	2.55
7008TL	1 ¹ / ₂ oz, 9 ¹ / ₄ " x 3", Rice Ladle	Dozen	41.89	2	30	2.55
7009TL	12 ¹ / ₂ " x 2 ¹ / ₂ ", Spatula/Turner	Dozen	41.89	2	30	2.49

**** Rice Ladle, Soup Spoon, Spatula and Turner shown on this page are not NSF Certified****



White



W7106



W7104



W7102



W7105



W7103



W7101



W7009

Item	Description	U/M	Weight Gross lbs	Inner Pack	Master Pack	Cu. Ft.
W7009	12" x 2½", Slide Turner	Dozen	40.96	2	30	2.49
W7101	12" x 2¾", Solid Turner	Dozen	40.96	2	30	4.35
W7102	12" x 2½", Solid Spoon	Dozen	41.76	2	30	2.83
W7103	12" x 2⅝", Slotted Spoon	Dozen	47.30	2	30	2.81
W7104	12" x 1⅞", Pasta Fork	Dozen	50.64	2	30	4.76
W7105	12" x 1¾", Salad Turner	Dozen	42.68	2	30	2.33
W7106	12" x 3½", Ladle	Dozen	61.00	2	30	4.78

Bamboo



7001BO



7005BO



7006BO



7007BO



7008BO



7009BO

Item	Description	U/M	Weight Gross lbs	Inner Pack	Master Pack	Cu. Ft.
7001BO	1 oz, 7⅞" x 2½", Soup Ladle	Dozen	33.07	5	40	2.08
7005BO	1½ oz, 8¼" x 2¾", Rice Ladle	Dozen	48.50	2	30	2.38
7006BO	2½ oz, 10¼" x 3 ⅜", Soup Ladle	Dozen	41.89	2	30	3.85
7007BO	2½ oz, 8⅞" x 2¾", Ladle/Spoon	Dozen	44.78	2	30	2.55
7008BO	1½ oz, 9¼" x 3", Rice Ladle	Dozen	41.89	2	30	2.55
7009BO	12½" x 2½", Spatula/Turner	Dozen	41.89	2	30	2.49

**** Rice Ladle, Soup Spoon, Spatula and Turner shown on this page are not NSF Certified****

Gastronorm Pans

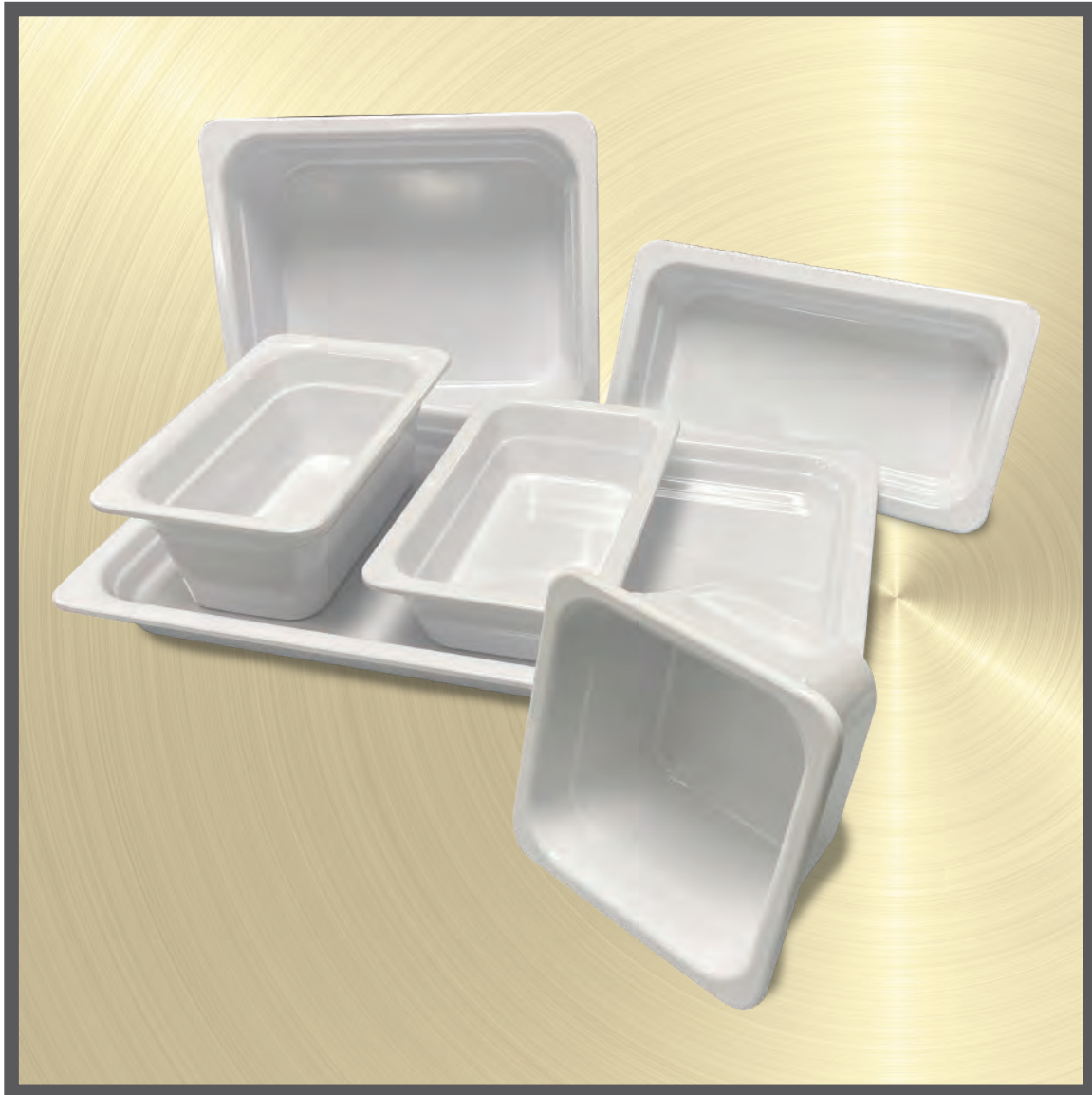

40mm • 65mm • 100mm



Stackable for storage



PMS, E., H., F., G., I., J., K., L., M., N., O., P., Q., R., S., T., U., V., W., X., Y., Z., AA, AB, AC, AD, AE, AF, AG, AH, AI, AJ, AK, AL, AM, AN, AO, AP, AQ, AR, AS, AT, AU, AV, AW, AX, AY, AZ, BA, BB, BC, BD, BE, BF, BG, BH, BI, BJ, BK, BL, BM, BN, BO, BP, BQ, BR, BS, BT, BU, BV, BW, BX, BY, BZ, CA, CB, CC, CD, CE, CF, CG, CH, CI, CJ, CK, CL, CM, CN, CO, CP, CQ, CR, CS, CT, CU, CV, CW, CX, CY, CZ, DA, DB, DC, DD, DE, DF, DG, DH, DI, DJ, DK, DL, DM, DN, DO, DP, DQ, DR, DS, DT, DU, DV, DW, DX, DY, DZ, EA, EB, EC, ED, EE, EF, EG, EH, EI, EJ, EK, EL, EM, EN, EO, EP, EQ, ER, ES, ET, EU, EV, EW, EX, EY, EZ, FA, FB, FC, FD, FE, FF, FG, FH, FI, FJ, FK, FL, FM, FN, FO, FP, FQ, FR, FS, FT, FU, FV, FW, FX, FY, FZ, GA, GB, GC, GD, GE, GF, GG, GH, GI, GJ, GK, GL, GM, GN, GO, GP, GQ, GR, GS, GT, GU, GV, GW, GX, GY, GZ, HA, HB, HC, HD, HE, HF, HG, HH, HI, HJ, HK, HL, HM, HN, HO, HP, HQ, HR, HS, HT, HU, HV, HW, HX, HY, HZ, IA, IB, IC, ID, IE, IF, IG, IH, II, IJ, IK, IL, IM, IN, IO, IP, IQ, IR, IS, IT, IU, IV, IW, IX, IY, IZ, JA, JB, JC, JD, JE, JF, JG, JH, JI, JJ, JK, JL, JM, JN, JO, JP, JQ, JR, JS, JT, JU, JV, JW, JX, JY, JZ, KA, KB, KC, KD, KE, KF, KG, KH, KI, KJ, KK, KL, KM, KN, KO, KP, KQ, KR, KS, KT, KU, KV, KW, KX, KY, KZ, LA, LB, LC, LD, LE, LF, LG, LH, LI, LJ, LK, LL, LM, LN, LO, LP, LQ, LR, LS, LT, LU, LV, LW, LX, LY, LZ, MA, MB, MC, MD, ME, MF, MG, MH, MI, MJ, MK, ML, MM, MN, MO, MP, MQ, MR, MS, MT, MU, MV, MW, MX, MY, MZ, NA, NB, NC, ND, NE, NF, NG, NH, NI, NJ, NK, NL, NM, NN, NO, NP, NQ, NR, NS, NT, NU, NV, NW, NX, NY, NZ, OA, OB, OC, OD, OE, OF, OG, OH, OI, OJ, OK, OL, OM, ON, OO, OP, OQ, OR, OS, OT, OU, OV, OW, OX, OY, OZ, PA, PB, PC, PD, PE, PF, PG, PH, PI, PJ, PK, PL, PM, PN, PO, PP, PQ, PR, PS, PT, PU, PV, PW, PX, PY, PZ, QA, QB, QC, QD, QE, QF, QG, QH, QI, QJ, QK, QL, QM, QN, QO, QP, QQ, QR, QS, QT, QU, QV, QW, QX, QY, QZ, RA, RB, RC, RD, RE, RF, RG, RH, RI, RJ, RK, RL, RM, RN, RO, RP, RQ, RR, RS, RT, RU, RV, RW, RX, RY, RZ, SA, SB, SC, SD, SE, SF, SG, SH, SI, SJ, SK, SL, SM, SN, SO, SP, SQ, SR, SS, ST, SU, SV, SW, SX, SY, SZ, TA, TB, TC, TD, TE, TF, TG, TH, TI, TJ, TK, TL, TM, TN, TO, TP, TQ, TR, TS, TT, TU, TV, TW, TX, TY, TZ, UA, UB, UC, UD, UE, UF, UG, UH, UI, UJ, UK, UL, UM, UN, UO, UP, UQ, UR, US, UT, UY, UZ, VA, VB, VC, VD, VE, VF, VG, VH, VI, VJ, VK, VL, VM, VN, VO, VP, VQ, VR, VS, VT, VU, VV, VW, VX, VY, VZ, WA, WB, WC, WD, WE, WF, WG, WH, WI, WJ, WK, WL, WM, WN, WO, WP, WQ, WR, WS, WT, WU, WV, WW, WX, WY, WZ, XA, XB, XC, XD, XE, XF, XG, XH, XI, XJ, XK, XL, XM, XN, XO, XP, XQ, XR, XS, XT, XU, XV, XW, XX, XY, XZ, YA, YB, YC, YD, YE, YF, YG, YH, YI, YJ, YK, YL, YM, YN, YO, YP, YQ, YR, YS, YT, YU, YV, YW, YX, YY, YZ, ZA, ZB, ZC, ZD, ZE, ZF, ZG, ZH, ZI, ZJ, ZK, ZL, ZM, ZN, ZO, ZP, ZQ, ZR, ZS, ZT, ZU, ZV, ZW, ZX, ZY, ZZ



1 1/2" Height / 40mm



2 1/2" Height / 65mm



4" Height / 100mm

Item	Description	U/M	Weight Gross lbs	Inner Pack	Master Pack	Cu. Ft.
GN1001W	1/1, 40mm, 20 3/4" x 12 3/4" x 1 1/2"	Each	51.50	4	12	2.12
GN1002W	1/1, 65mm, 20 3/4" x 12 3/4" x 2 1/2"	Each	42.20	2	8	2.94
GN1004W	1/1, 100mm, 20 3/4" x 12 3/4" x 4"	Each	47.11	2	8	3.82
GN1121W	1/2, 40mm, 12 3/4" x 10 3/8" x 1 1/2"	Each	44.88	6	24	1.89
GN1122W	1/2, 65mm, 12 3/4" x 10 3/8" x 2 1/2"	Each	36.99	4	16	2.16
GN1124W	1/2, 100mm, 12 3/4" x 10 3/8" x 4"	Each	42.79	4	16	2.72
GN1132W	1/3, 65mm, 12 3/4" x 6 7/8" x 2 1/2"	Each	42.57	6	24	1.88
GN1134W	1/3, 100mm, 12 3/4" x 7" x 4"	Each	46.65	6	24	2.33
GN1142W	1/4, 65mm, 10 1/2" x 6 3/8" x 2 1/2"	Each	42.13	6	24	1.66
GN1144W	1/4, 100mm, 10 1/2" x 6 1/4" x 4"	Each	39.88	6	24	1.77
GN1162W	1/6, 65mm, 7" x 6 3/8" x 2 1/2"	Each	41.89	12	36	1.50
GN1164W	1/6, 100mm, 7" x 6 3/8" x 4"	Each	41.03	12	36	1.65
GN1221W	2/4, 40mm, 20 3/4" x 6 3/8" x 1 1/2"	Each	48.55	6	24	1.89
GN1222W	2/4, 65mm, 20 3/4" x 6 3/8" x 2 1/2"	Each	43.17	4	16	2.28
GN1232W	2/3, 65mm, 14" x 12 7/8" x 2 1/2"	Each	30.27	2	8	1.96



ASIAN COOKWARE

ASIAN COOKWARE



BANP001

BANP002

WOOD ROLLING PIN (ASIAN STYLE)

Use to roll out various types of dough when making food items.

ITEM	DESCRIPTION	U/M	WEIGHT GROSS lbs	INNER PACK	MASTER PACK	CU. FT.
BANP001	12", 1" Diameter	EACH	31.97	1	120	0.88
BANP002	14", 1" Diameter	EACH	34.17	1	120	1.02



WDSP012
WDSP014
WDSP016
WDSP018

WOODEN SPOON

Use for stirring sauces, soups and other cooking needs.

ITEM	DESCRIPTION	U/M	WEIGHT GROSS lbs	INNER PACK	MASTER PACK	CU. FT.
WDSP012	12"	EACH	7.50	12	72	0.42
WDSP014	14"	EACH	8.20	12	72	0.49
WDSP016	16"	EACH	8.82	12	72	0.57
WDSP018	18"	EACH	9.70	12	72	0.62



SLLD309
SLLD310
SLLD311

SLSPA001
SLSPA002

SHOVEL & LADLE WITH WOOD HANDLE

Stainless steel ladle and shovel both come with hardwood handle. Arm extends up to 19 3/4" for deep pots and safety.

ITEM	DESCRIPTION	U/M	WEIGHT GROSS lbs	INNER PACK	MASTER PACK	CU. FT.
SLLD309	6 oz, 4" x 4 1/4" x 16 3/4"	EACH	41.80	25	100	1.79
SLLD310	8 oz, 4 1/4" x 4 1/2" x 18"	EACH	52.91	25	100	2.05
SLLD311	10 oz, 4 1/2" x 5" x 19 3/4"	EACH	63.93	25	100	2.28
SLSPA001	4 1/2" x 4 1/2" x 19 1/2"	EACH	48.50	25	100	2.09
SLSPA002	4" x 4 1/4" x 17 3/4"	EACH	44.09	25	100	1.87



MRGR001
MRGR002
MRGR003

MARBLE GRINDER

Bowl style marble grinder. Ideal for blending spices and herbs.

Made in Taiwan

ITEM	DESCRIPTION	U/M	WEIGHT GROSS lbs	INNER PACK	MASTER PACK	CU. FT.
MRGR001	4" Diameter x 2 5/8" Height	EACH	39.68	12	12	1.09
MRGR002	5" Diameter x 4 1/2" Height	EACH	41.89	8	8	1.23
MRGR003	3" Diameter x 2 1/8" Height	EACH	39.68	24	24	1.33

ALUMINUM BASIN

With tapered edges.



ITEM	DESCRIPTION	U/M	WEIGHT GROSS lbs	INNER PACK	MASTER PACK	CU. FT.
ALBS001	19" x 6"	EACH	17.64	1	10	2.34
ALBS002	20" x 6"	EACH	24.25	1	10	2.58
ALBS003	21½" x 6½"	EACH	25.35	1	10	2.99
ALBS004	23" x 7"	EACH	28.66	1	10	3.68
ALBS005	25" x 7"	EACH	33.07	1	10	5.00
ALBS006	27" x 7½"	EACH	44.09	1	10	6.05
ALBS007	30" x 7½"	EACH	57.32	1	10	7.35



ALBS001

ASIAN STYLE ALUMINUM COLANDER

With tapered edges.



ITEM	DESCRIPTION	U/M	WEIGHT GROSS lbs	INNER PACK	MASTER PACK	CU. FT.
ALSB001	19½" x 6"	EACH	29.76	1	20	3.35
ALSB002	17½" x 5"	EACH	28.66	1	20	2.76
ALSB003	15¾" x 1½"	EACH	20.28	1	20	2.02
ALSB004	15" x 4"	EACH	19.84	1	20	1.72
ALSB005	13¼" x 4"	EACH	26.46	1	20	1.24
ALSB006	12" x 3¼"	EACH	28.66	1	20	0.79
ALSB007	11" x 3"	EACH	17.64	1	20	0.79
ALSB008	10" x 3"	EACH	26.46	1	20	0.62
ALSB009	8½" x 2¾"	EACH	19.84	1	20	0.49



ALSB001



ALSB009

BAMBOO SKEWER

Thin, smooth-pointed bamboo skewers. Use for barbecues, or simply for holding ingredients together while cooking. 100 pcs/bag

ITEM	DESCRIPTION	U/M	WEIGHT GROSS lbs	INNER PACK	MASTER PACK	CU. FT.
BAST006	6"	BAG	17.64	30	120	0.57
BAST008	8"	BAG	23.15	30	120	0.74
BAST010	10"	BAG	35.27	30	120	1.30
BAST012	12"	BAG	48.50	30	120	1.54



BAST010

BAMBOO HANDLE SKIMMER (COARSE MESH)

Round framed stainless steel mesh wires with riveted bamboo handle. Elongated handle is excellent for added safety precaution while deep frying or skimming. Concave net captures food while straining oil and other liquids.



ITEM	DESCRIPTION	U/M	WEIGHT GROSS lbs	INNER PACK	MASTER PACK	CU. FT.
SLSKR004	4" x 13½"	EACH	28.66	1	200	2.53
SLSKR006	6" x 16"	EACH	50.71	1	200	5.04
SLSKR008	8" x 19"	EACH	26.06	1	50	2.88
SLSKR010	10" x 21"	EACH	20.04	1	30	2.97
SLSKR012	12" x 26"	EACH	30.07	1	30	4.94
SLSKR014	14" x 28"	EACH	40.08	1	30	6.31



SLSKR004 ~ SLSKR014



SLNS001

SLNS002



SLNS005

SLNS536

SLNS553

NOODLE SKIMMER

Sturdy stainless steel wiring with outer framework and wood handle. Deep pockets catch noodles securely while straining water, oil or other liquids. Convenient storage with built in hook hanger.



ITEM	DESCRIPTION	U/M	WEIGHT GROSS lbs	INNER PACK	MASTER PACK	CU. FT.
SLNS001	5½" x 5½" x 13¾" Flat Wood Handle	EACH	33.07	12	72	3.92
SLNS002	5½" x 5½" x 13¾" Round Wood Handle	EACH	31.11	12	72	3.92
SLNS005	5½" x 4¼" Bamboo Handle	EACH	26.40	1	50	2.99
SLNS536	5½" x 6" Flat Bottom, Round, S/S w/ Wood Handle	EACH	26.01	1	36	4.68
SLNS553	5" x 5¼" Flat Bottom, Round, S/S with Wood Handle	EACH	19.67	1	36	3.67

SKIMMER FOR SHABU SHABU

Ideal for scooping small food items in Shabu-shabu and Chinese hot pots.



HPCS008

ITEM	DESCRIPTION	U/M	WEIGHT GROSS lbs	INNER PACK	MASTER PACK	CU. FT.
HPCS008	2½" Diameter x 8¾" Length	EACH	31.53	200	1000	2.65

BAMBOO HANDLE SKIMMER



SLSKR004GV ~
SLSKR014GV



SLSKR104GV ~ SLSKR612GV

ITEM	DESCRIPTION	U/M	WEIGHT GROSS lbs	INNER PACK	MASTER PACK	CU. FT.
Coarse Mesh						
SLSKR004GV	4"	EACH	34.11	1	200	2.69
SLSKR006GV	6"	EACH	44.09	1	200	5.42
SLSKR008GV	8"	EACH	31.00	1	50	2.88
SLSKR010GV	10"	EACH	22.05	1	30	3.19
SLSKR012GV	12"	EACH	34.61	1	30	4.94
SLSKR014GV	14"	EACH	47.40	1	30	6.31
Fine Mesh						
SLSKR104GV	4"	EACH	32.87	1	200	2.69
SLSKR106GV	6"	EACH	72.75	1	200	5.42
SLSKR108GV	8"	EACH	34.17	1	50	2.88
SLSKR110GV	10"	EACH	26.00	1	30	3.19
SLSKR112GV	12"	EACH	41.01	1	30	4.94
SLSKR114GV	14"	EACH	53.99	1	30	6.31
Bowl						
SLSKR512GV	5" x 2½"	EACH	17.64	1	50	1.72
Flat						
SLSKR612GV	6" x 1½"	EACH	17.59	1	50	1.87

CARVING KNIFE

Stainless steel blades with riveted wooden handle.

Made in Taiwan

ITEM	DESCRIPTION	U/M	WEIGHT GROSS lbs	INNER PACK	MASTER PACK	CU. FT.
JAS013090	3½" Carving Knife	EACH	26.46	12	120	2.40
SLCN001	Carving Knife/Set of 6	SET	30.42	1	120	2.00



JAS013090



SLCN001

JAPANESE KNIFE

Stainless steel blades, with riveted wooden handle.

Made in Taiwan

ITEM	DESCRIPTION (BLADE SIZE)	U/M	WEIGHT GROSS lbs	INNER PACK	MASTER PACK	CU. FT.
JAS013001	7.5" x 1.65"	EACH	26.46	6	60	2.00
JAS013002	6.5" x 1.9"	EACH	26.46	6	60	2.00
JAS013003	11.5" x 1.9"	EACH	28.66	6	60	2.03



JAS013001



JAS013002



JAS013003

JAPANESE SASHIMI KNIFE

Stainless steel blades, with riveted wooden handle. Finely slices sashimi into the required texture. Makes a great tool for sushi bars.

Made in Taiwan

ITEM	DESCRIPTION (BLADE SIZE)	U/M	WEIGHT GROSS lbs	INNER PACK	MASTER PACK	CU. FT.
JAS014210	8½" x 1½"	EACH	39.68	6	60	2.20
JAS014240	9½" x 1½"	EACH	39.68	6	60	2.50
JAS014270	10¾" x 1½"	EACH	44.09	6	60	2.50
JAS014300	12" x 1½"	EACH	48.50	6	60	2.50



JAS014210



JAS014240



JAS014270



JAS014300

JAPANESE COW KNIFE

Durable stainless steel knives with riveted ABS handles. Withstands any wear and tear from cutting through beef. Chops and cuts meat with precision.

Made in Taiwan

ITEM	DESCRIPTION (BLADE SIZE)	U/M	WEIGHT GROSS lbs	INNER PACK	MASTER PACK	CU. FT.
JAS012180	7½" x 1¼"	EACH	44.09	6	60	2.33
JAS012210	8¾" x 1¼"	EACH	46.30	6	60	2.33
JAS012240	9½" x 1¼"	EACH	48.50	6	60	2.33
JAS012270	10½" x 2"	EACH	55.12	6	60	2.33
JAS012300	11¾" x 2½"	EACH	57.32	6	60	2.33
JAS012330	13" x 2¼"	EACH	60.63	6	60	2.60



JAS012180



JAS012210



JAS012240



JAS012270



JAS012300



JAS012330



SLKF002

SHARP KNIFE

Stainless steel knife with a sharp angled tip. Balanced wooden handle.

Made in Taiwan

ITEM	DESCRIPTION (BLADE SIZE)	U/M	WEIGHT GROSS lbs	INNER PACK	MASTER PACK	CU. FT.
SLKF002	7.2" x 2.9"	EACH	44.09	1	50	2.49



SLKF021

KING KNIFE

Sharp stainless steel king knife for chopping, slicing and dicing. With wooden handle. Blade size in 7". Also available in Kimli (retailed boxed).

Made in Taiwan

ITEM	DESCRIPTION (BLADE SIZE)	U/M	WEIGHT GROSS lbs	INNER PACK	MASTER PACK	CU. FT.
SLKF021	7" x 3½"	EACH	44.09	1	50	2.40



SLKF003HK

SLKF004HK

SLKF005HK

PING KNIFE

Provides professional results with reliable cast iron blade. Made to last through heavy duty professional use. Comes with a wooden handle.

Made in Taiwan

ITEM	DESCRIPTION (BLADE SIZE)	U/M	WEIGHT GROSS lbs	INNER PACK	MASTER PACK	CU. FT.
SLKF003HK	9¼" x 4½"	EACH	46.72	1	50	2.50
SLKF004HK	8½" x 4¼"	EACH	40.94	1	50	2.50
SLKF005HK	7¾" x 4"	EACH	38.58	1	50	2.50



JAS010055A

JAS010055B

SHARP AND ANGLE KNIFE

For the proper preparation of vegetables and meats. Sharp stainless steel blade riveted onto wooden handle. Blade size available in 6¾" and 7". Sharp or angled.

Made in Taiwan

ITEM	DESCRIPTION (BLADE SIZE)	U/M	WEIGHT GROSS lbs	INNER PACK	MASTER PACK	CU. FT.
JAS010055A	11" x 3"	EACH	59.52	6	60	2.46
JAS010055B	11" x 3½"	EACH	59.52	6	60	2.46

PING & WAN WOO KNIFE (SQUARE HEAD)

Cast iron square head knife with wooden handle. A great addition to any knife collection.

Made in Taiwan

ITEM	DESCRIPTION (BLADE SIZE)	U/M	WEIGHT GROSS lbs	INNER PACK	MASTER PACK	CU. FT.
SLKF012	9½" x 4½" Wan Woo Knife	EACH	72.35	1	50	1.26
SLKF018	8¼" x 4¼" Ping Knife	EACH	39.01	1	50	1.65

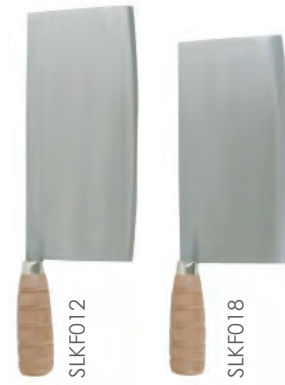

PING & WAN WOO KNIFE (ROUND HEAD)

Cast iron round head knife with wooden handle. A great addition to any knife collection.

Made in Taiwan

ITEM	DESCRIPTION (BLADE SIZE)	U/M	WEIGHT GROSS lbs	INNER PACK	MASTER PACK	CU. FT.
SLKF019	9" x 4½" Wan Woo Knife	EACH	60.22	1	50	1.68
SLKF025	9" x 4¼" Shanghai Ping Knife	EACH	38.90	1	50	1.65



CHINESE CLEAVER

For slicing through bones and other tough textures. Features a cast iron square-headed blade and wooden handle. Essential for meat and poultry preparation.

Made in Taiwan

ITEM	DESCRIPTION (BLADE SIZE)	U/M	WEIGHT GROSS lbs	INNER PACK	MASTER PACK	CU. FT.
SLKF016	8½" x 4½" Bone Knife	EACH	100.59	1	50	1.64
SLKF017	7½" x 4" Meat Knife	EACH	72.12	1	50	1.68
SLKF020	8" x 2" Duck Knife	EACH	20.19	1	50	1.48



ASIAN CLEAVER

Sharp and precise for chopping through tough meat and bones. Stainless steel blade with riveted wooden handle.

ITEM	DESCRIPTION (BLADE SIZE)	U/M	WEIGHT GROSS lbs	INNER PACK	MASTER PACK	CU. FT.
OW189	6" x 2¾"	EACH	22.05	6	48	0.43





ALSR001

WOK RACK

Steel wok rack, with open top and perforated sides on flat steady rim. Offers support by holding heavy woks in place on the table or counter. Helps to keep the kitchen safe.

Made in Taiwan

ITEM	DESCRIPTION	U/M	WEIGHT GROSS lbs	INNER PACK	MASTER PACK	CU. FT.
ALSR001	Top: 8 1/4" Diameter, Bottom: 10" Diameter	EACH	28.66	1	100	1.17



ALPC001, ALPC002

WOK COVER

Keeps oil splatters, heat, or any other contents contained in the wok.

A ALUMINUM Made in Taiwan

ITEM	DESCRIPTION	U/M	WEIGHT GROSS lbs	INNER PACK	MASTER PACK	CU. FT.
ALPC001	12 1/4" Diameter	EACH	13.00	1	60	1.10
ALPC002	13 1/4" Diameter	EACH	15.15	1	60	2.10

SLWK008C



SLWK008

STAINLESS STEEL WOK & COVER

Stainless steel wok with handle.

SS STAINLESS STEEL

ITEM	DESCRIPTION	U/M	WEIGHT GROSS lbs	INNER PACK	MASTER PACK	CU. FT.
SLWK008C	Cover 7 3/4"	EACH	31.90	1	60	0.23
SLWK008	Wok 8"	EACH	41.89	1	60	0.60

CURVED RIM WOK

Prevents drips with curved rim. Heavy iron wok with rounded handles.

Made in Taiwan



IRWC001 ~ IRWC005

ITEM	DESCRIPTION	U/M	WEIGHT GROSS lbs	INNER PACK	MASTER PACK	CU. FT.
IRWC001	19"	EACH	4.19	1	1	0.27
IRWC002	21 1/2"	EACH	6.28	1	1	0.40
IRWC003	24"	EACH	6.83	1	1	0.64
IRWC004	26"	EACH	8.38	1	1	0.77
IRWC005	28 3/4"	EACH	9.70	1	1	1.44

NON-STICK WOOD HANDLE WOK

A functional non-stick wok. Heavy carbon steel wok with wooden handles. Good leverage.

Made in Taiwan

ITEM	DESCRIPTION	U/M	WEIGHT GROSS lbs	INNER PACK	MASTER PACK	CU. FT.
TF001	12"	EACH	30.86	1	12	1.00
TF002	14" w/Helper Handle	EACH	39.68	1	12	1.70



TF002

JAPANESE JIN-PING WOK (ONE PIECE STEEL)

Japanese Jin-Ping Woks. Extra strength steel with reinforced sandwiched welding.

ITEM	DESCRIPTION	U/M	WEIGHT GROSS lbs	INNER PACK	MASTER PACK	CU. FT.
IRJWC001	14"	EACH	38.80	1	12	1.56
IRJWC002	16"	EACH	46.30	1	12	2.01
IRJWC301	14"	EACH	33.51	1	10	1.77
IRJWC302	16"	EACH	38.80	1	10	2.12

Made in Taiwan

Made in Taiwan

Made in Japan

Made in Japan



IRJWC001, IRJWC002



Sandwich Weld



IRJWC301, IRJWC302

TAIWAN WOK

Heavy-duty iron wok. A valuable tool for cooking.

Made in Taiwan

ITEM	DESCRIPTION	U/M	WEIGHT GROSS lbs	INNER PACK	MASTER PACK	CU. FT.
IRWK001	14"	EACH	39.68	1	12	1.88
IRWK002	16"	EACH	46.30	1	12	2.45



IRWK001, IRWK002

WOOD HANDLE WOK

Iron wok for professional use. Made to last through excessive use. Comes with a wooden handle.

Made in Taiwan

ITEM	DESCRIPTION	U/M	WEIGHT GROSS lbs	INNER PACK	MASTER PACK	CU. FT.
IRWC006	14"	EACH	2.76	1	1	1.03
IRWC007	16"	EACH	3.20	1	1	0.28



IRWC006, IRWC007



ALSP002, ALSP003, ALSP004

SNOW FLAT PAN

Studded with round imprints. Wooden handle with a built-in hanging loop.



ITEM	DESCRIPTION	U/M	WEIGHT GROSS lbs	INNER PACK	MASTER PACK	CU. FT.
ALSP002	7 1/4" x 2 3/4"	EACH	33.07	20	120	8.30
ALSP003	8" x 3"	EACH	37.50	20	120	9.30
ALSP004	9" x 3"	EACH	28.66	20	80	8.90



SLSTP714

ONE HANDLE POT WITH LID

Mirror polished stainless steel pot with lid. A great tool for preparing authentic cuisines.



ITEM	DESCRIPTION	U/M	WEIGHT GROSS lbs	INNER PACK	MASTER PACK	CU. FT.
SLSTP714	7 1/4" Diameter One Handle Pot	EACH	15.43	1	12	1.83



CETW001

SAN BAI WOK

Durable aluminum broiler comes with wok and lid.



ITEM	DESCRIPTION	U/M	WEIGHT GROSS lbs	INNER PACK	MASTER PACK	CU. FT.
CETW001	6"	EACH	17.09	1	10	0.68
CETW002	7"	EACH	25.35	1	10	1.10
CETW003	8"	EACH	27.56	1	10	1.40
CETW004	9"	EACH	34.17	1	10	1.70
CETW005	10"	EACH	52.91	1	10	2.92



IRTP001, IRTP002

BBQ PLATE (CAST IRON)

Heavy-duty cast iron plate with concave shape to fit exactly on burner. Ridges added for attractive grilled texture on tortillas, pita breads, etc.

ITEM	DESCRIPTION	U/M	WEIGHT GROSS lbs	INNER PACK	MASTER PACK	CU. FT.
IRTP001	11 1/2" BBQ Plate	EACH	41.89	1	6	1.22
IRTP002	10 1/4" BBQ Plate	EACH	44.53	1	8	1.06

ALUMINUM STEAMERS

A complete set of four parts, with bottom, two middle perforated stacks, and lid. Handles built into all sides of all compartments for safe handling while hot. Efficiently steams vegetables and other ingredients.

*Larger sizes ALST013 through ALST016, come without bottom.

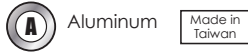

ALST013~016

ITEM	DESCRIPTION	U/M	WEIGHT GROSS lbs	INNER PACK	MASTER PACK	CU. FT.
Small Hole Steamers with Bottom and Lid (Hole size: 1/8")						
ALST001	11 3/8" x 12 1/2"	SET	2.43	1	1	0.79
ALST003	11 1/2" x 14 1/2"	SET	2.86	1	1	0.85
ALST005	13" x 19 1/2"	SET	3.75	1	1	1.37
ALST007	15" x 20 1/4"	SET	4.52	1	1	1.76
Big Hole Steamers with Bottom and Lid (Hole size: 3/8")						
ALST002	11 3/8" x 12 1/2"	SET	2.43	1	1	0.80
ALST004	11 1/2" x 14 1/2"	SET	2.86	1	1	0.85
ALST006	13" x 19 1/2"	SET	3.75	1	1	1.37
ALST008	15" x 20 1/4"	SET	4.52	1	1	1.81
ALST010	17" x 21 1/2"	SET	6.00	1	1	2.37
ALST011	19" x 22 5/8"	SET	7.94	1	1	3.11
ALST012	21" x 25 1/2"	SET	12.57	1	1	3.01
Steamers without Bottom, Heavy Duty						
ALST013	19 1/2" x 18"	SET	12.79	1	1	3.80
ALST014	22" x 21"	SET	14.55	1	1	4.70
ALST015	23" x 19"	SET	17.64	1	1	5.80
ALST016	26" x 22"	SET	19.40	1	1	7.60

BURNER

High-powered Jet Burners and Duck Burners. Power ranges from 62,000 to 160,000 BTU. Replacement nozzles available separately.



Jet Burner



Duck Burner

Jet Burner Nozzle
IRBN001L, IRBN001N



Duck Burner Nozzle
IRBN002L, IRBN002N

Jet Burner Pin
IRBN003N

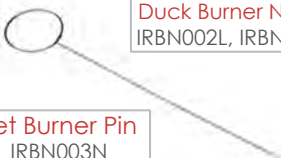

ITEM	DESCRIPTION	U/M	WEIGHT GROSS lbs	INNER PACK	MASTER PACK	CU. FT.
JET BURNER						
IRBR001L	20 Burner - Propane	EACH	41.89	8	8	0.80
IRBR001N	20 Burner - Natural Gas	EACH	41.89	8	8	0.80
IRBR002CL	23 Burner - Propane	EACH	44.53	8	8	1.12
IRBR002CN	23 Burner - Natural Gas	EACH	44.53	8	8	1.12
IRBR002L	23 Burner - Propane	EACH	40.70	8	8	0.50
IRBR002N	23 Burner - Natural Gas	EACH	40.70	8	8	0.50
IRBR003CL	32 Burner - Propane	EACH	41.89	5	5	1.31
IRBR003CN	32 Burner - Natural Gas	EACH	41.89	5	5	1.31
IRBR003L	32 Burner - Propane	EACH	42.99	5	5	0.95
IRBR003N	32 Burner - Natural Gas	EACH	42.99	5	5	0.95

Made in Taiwan

Made in Taiwan

Made in Taiwan

Made in Taiwan

DUCK BURNER

IRBR004CL	18 Burner - Propane	EACH	41.89	6	6	1.04
IRBR004CN	18 Burner - Natural Gas	EACH	41.89	6	6	1.04
IRBR004L	18 Burner - Propane	EACH	42.99	6	6	0.94
IRBR004N	18 Burner - Natural Gas	EACH	42.99	6	6	0.94

Made in Taiwan

Made in Taiwan

**** Sold by Master Pack Only ****

BURNER NOZZLE

ITEM	DESCRIPTION	U/M	WEIGHT GROSS lbs	INNER PACK	MASTER PACK	CU. FT.
IRBN001L	Jet Burner - Propane	EACH	45.19	100	1000	0.54
IRBN001N	Jet Burner - Natural Gas	EACH	45.19	100	1000	0.54
IRBN002L	Duck Burner - Propane	EACH	44.09	50	250	0.50
IRBN002N	Duck Burner - Natural Gas	EACH	44.09	50	250	0.50
IRBN003N	Jet Burner Pin, 5pc/pack	PACK	1.65	1	100	0.13

Made in Taiwan

FAST STOVE

Heavy-duty Fast Stove, built with burner that can quickly be adjusted to low and high settings. It will not scorch meals while cooking. Comes with hose and gas nozzle.

PROPANE ONLY.

ITEM	DESCRIPTION	U/M	WEIGHT GROSS lbs	INNER PACK	MASTER PACK	CU. FT.
IRFS001	5B, 76,800 BTU	EACH	20.94	1	1	1.19
IRFS002	HL-202, 16,800 BTU	EACH	16.43	1	1	0.75
IRFS003	5A (Copper Nozzle), 91,200 BTU	EACH	20.94	1	1	1.20
H-205	5B-Automatic, 64,800 BTU	EACH	22.75	1	1	1.13

Fast Stove Parts

IRFS004	5½" x ¾" x 2¾" Aluminum	EACH	35.27	50	200	0.64
---------	-------------------------	------	-------	----	-----	------



IRFS001



IRFS002



IRFS004



H-205



IRFS003

INSULATED SUSHI RICE POT

Keeps sushi rice moist without the need for electricity. Stainless steel top cover and lining. Easy to clean. Holds moisture in. Wood grain finish.



Wood Grain Exterior

ITEM	DESCRIPTION	U/M	WEIGHT GROSS lbs	INNER PACK	MASTER PACK	CU. FT.
SEJ71000	40 Cups	EACH	15.00	1	1	2.42
SEJ73000	60 Cups	EACH	17.00	1	1	2.81

SEJ71000, SEJ73000



Stainless Steel Exterior

ITEM	DESCRIPTION	U/M	WEIGHT GROSS lbs	INNER PACK	MASTER PACK	CU. FT.
SEJ72000	40 Cups	EACH	15.00	1	1	2.42
SEJ74000	60 Cups	EACH	17.00	1	1	2.81

SEJ72000, SEJ74000



ASIAN TABLEWARE



ASIAN TABLEWARE



BAMBOO SOUP SPOON

Soup spoon made with bamboo handle. Easy to wash and maintain.

ITEM	DESCRIPTION	U/M	WEIGHT GROSS lbs	INNER PACK	MASTER PACK	CU. FT.
30-27	4" x 11"	EACH	44.00	40	480	4.06
30-28	3" x 8½"	EACH	30.80	40	480	4.39
30-55	3" x 8½"	EACH	30.80	40	480	4.25



DONBURI BOWL WITH LADLE

Japanese style, comes with bowl, lid, and ladle. Excellent for soup and noodle.

Made in Taiwan

ITEM	DESCRIPTION	U/M	WEIGHT GROSS lbs	INNER PACK	MASTER PACK	CU. FT.
PLN001	30 oz, 6" Diameter, Red	EACH	39.60	1	60	5.80
PLN002	30 oz, 6" Diameter, Black	EACH	39.60	1	60	5.80



45-1



45-2



45-3



45-4



45-5



45-8



45-35

WOOD MISO & RICE BOWL

Assorted rice and miso soup bowls. Wood carved with clear finish for protection.

ITEM	DESCRIPTION	U/M	WEIGHT GROSS lbs	INNER PACK	MASTER PACK	CU. FT.
45-1	16½ oz, 5½" x 4⅞"	DOZEN	33.01	0.5	6	4.13
45-2	10½ oz, 4¼" x 2½"	DOZEN	28.88	1	12	2.77
45-3	9 oz, 4" x 2½"	DOZEN	33.32	1	12	4.63
45-4	9 oz, 4¾" x 2¼"	DOZEN	33.01	1	12	3.07
45-5	9 oz, 4¾" x 2¼"	DOZEN	34.59	1	12	3.22
45-8	9 oz, 4" x 2½"	DOZEN	30.15	1	12	2.59
45-35	9 oz, 3¾" x 2¾"	DOZEN	36.18	1	12	3.57

PLASTIC SUSHI PARTY TRAY

Container to accommodate large quantities of sushi. Ideal for use at parties or to accommodate large crowds serving.

ITEM	DESCRIPTION	U/M	WEIGHT GROSS lbs	INNER PACK	MASTER PACK	CU. FT.
PLSPT0802	8½" x 2¾"	EACH	18.10	1	18	1.84
PLSPT0902	9½" x 2¼"	EACH	22.44	1	18	2.78
PLSPT1102	11¾" x 2¾"	EACH	29.67	1	18	4.82



HAND ROLL RACK

Convenient rack to hold sushi rolls. Accommodates 3, 5, or 10 rolls at once.

Made in Taiwan

ABS

ITEM	DESCRIPTION	U/M	WEIGHT GROSS lbs	INNER PACK	MASTER PACK	CU. FT.
29	7" x 4" x 3¼" 3 Cavities	EACH	12.80	1	60	3.30
30	10¼" x 4¼" x 3¼" 5 Cavities	EACH	11.90	1	40	3.50
53	8½" x 8½" x 4⅞" 10 Cavities	EACH	14.30	1	24	3.80

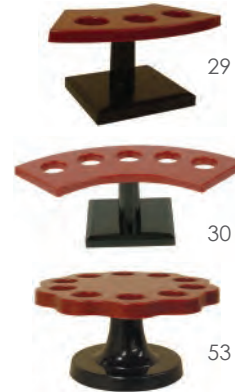

OBON SERVING TRAY

Japanese Lacquer Ware with coated finish to resist water and moisture.

Made in Taiwan

ITEM	DESCRIPTION	U/M	WEIGHT GROSS lbs	INNER PACK	MASTER PACK	CU. FT.
PLA013	13" x 9½"	EACH	59.40	12	72	4.20
PLA016	15½" x 11½"	EACH	81.60	12	84	3.20



PLA013

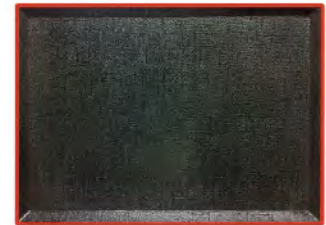

PLA016

MAKUNOUCHI BENTO BOX

Japanese style lunch box with decorative exterior. Comes with removable inner tray or fixed interior. Separate compartments for each item.

Made in Taiwan

ITEM	DESCRIPTION	U/M	WEIGHT GROSS lbs	INNER PACK	MASTER PACK	CU. FT.
JPRB001	10⅝" x 8⅜" x 3½" w/ Removable Trays	EACH	48.18	1	24	4.80
JPRB002	10⅝" x 8⅜" x 3½"	EACH	35.64	1	24	4.80

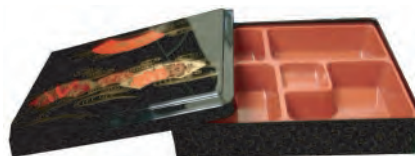

JPRB001



JPRB002



WOBR43
WOBR57

WOOD BRIDGE

Decorative platter for assorted recipes. Crafted in wood.

ITEM	DESCRIPTION	U/M	WEIGHT GROSS lbs	INNER PACK	MASTER PACK	CU. FT.
WOBR43	17" x 13 $\frac{3}{8}$ " x 4"	EACH	20.94	1	5	2.90
WOBR57	22 $\frac{1}{2}$ " x 17 $\frac{1}{2}$ " x 4 $\frac{1}{2}$ "	EACH	39.68	1	5	5.50

WOOD BOAT

Festive wooden boat to decorate and display assorted recipes.



WOBOAT61
WOBOAT76
WOBOAT90

ITEM	DESCRIPTION	U/M	WEIGHT GROSS lbs	INNER PACK	MASTER PACK	CU. FT.
WOBOAT61	24" x 8" x 14"	EACH	48.40	1	6	5.80
WOBOAT76	30" x 9 $\frac{1}{2}$ " x 16 $\frac{3}{8}$ "	EACH	24.25	1	4	6.55
WOBOAT90	35 $\frac{1}{2}$ " x 12" x 7"	EACH	33.00	1	4	9.99

IRPA001



NABEMONO BOWL (CAST IRON)

Large stew bowl for hot recipes. Durable cast iron construction. Includes wooden lid and base.

ITEM	DESCRIPTION	U/M	WEIGHT GROSS lbs	INNER PACK	MASTER PACK	CU. FT.
IRPA001	24 oz, 7" Diameter	EACH	52.80	1	18	2.10
IRPA002	32 oz, 7" Diameter	EACH	43.14	1	12	2.01
IRPA003	40 oz, 7 $\frac{1}{2}$ " Diameter	EACH	55.00	1	8	2.40

IRPA002



IRPA003



IRPA004



SHABU SHABU NABE BOWL (ALUMINUM ALLOY)

Use this large Shabu Shabu pot to accommodate for large groups.

ITEM	DESCRIPTION	U/M	WEIGHT GROSS lbs	INNER PACK	MASTER PACK	CU. FT.
IRPA004	32 oz, 7 $\frac{5}{8}$ " x 7" 9 $\frac{3}{4}$ "	EACH	52.35	1	36	6.30

SHIRAKI WOOD SUSHI SERVER

Large sushi server to accommodate large parties servings.

ITEM	DESCRIPTION	U/M	WEIGHT GROSS lbs	INNER PACK	MASTER PACK	CU. FT.
Y-55	12½" x 8"	EACH	28.66	1	12	2.18
Y-35	16½" x 10¼"	EACH	39.68	1	10	3.39
Y-15	21½" x 13¼"	EACH	39.68	1	6	4.36



BAMBOO SUSHI PLATE

Light weight bamboo plate to accommodate single sushi serving plate.

ITEM	DESCRIPTION	U/M	WEIGHT GROSS lbs	INNER PACK	MASTER PACK	CU. FT.
WSPB001	8½" x 4¾" x 1¼"	EACH	17.60	6	24	0.96
WSPB002	9½" x 6" x 1¼"	EACH	21.85	6	24	1.26
WSPB003	10½" x 7" x 1¼"	EACH	24.20	6	24	1.63



WOOD SUSHI PLATE

Wooden individual sushi plate. Ideal for customers served at shushi bar counter.

ITEM	DESCRIPTION	U/M	WEIGHT GROSS lbs	INNER PACK	MASTER PACK	CU. FT.
WSPW001	8½" x 4¾" x 2¼"	EACH	22.05	6	24	1.76
WSPW002	9½" x 6" x 2¼"	EACH	26.46	6	24	2.43
WSPW003	10½" x 7" x 2¼"	EACH	27.56	6	24	3.24



SHIRAKI WOOD SHOYU HOLDER

Shiraki wood made dispenser for soy sauce and condiment dispensers. Compact and decorative.

ITEM	DESCRIPTION	U/M	WEIGHT GROSS lbs	INNER PACK	MASTER PACK	CU. FT.
Y-75	9" x 5"	EACH	24.25	6	36	1.74
Y-95	8" x 4½"	EACH	24.25	6	36	1.59
K109	6½" x 3¾" with Handle	EACH	30.86	7	42	2.80



TOOTHPICKS

Round toothpicks made of bamboo. Packed.

ITEM	DESCRIPTION	U/M	WEIGHT GROSS lbs	INNER PACK	MASTER PACK	CU. FT.
BATP001	Bamboo Tooth Pick, 10 Bag/Pack	PACK	25.60	1	50	1.01



SLAL01A
Wok Set



SLAL01B
Wok Body



SLAL005
Base Only

ALCOHOL WOK

Stainless steel woks with stand to keep meals nice and hot. Wok includes handles and lid.

ITEM	DESCRIPTION	U/M	WEIGHT GROSS lbs	INNER PACK	MASTER PACK	CU. FT.
SLAL01A	7½" Alcohol Wok Set	SET	41.89	1	24	4.08
SLAL02A	9" Alcohol Wok Set	SET	68.20	1	24	5.14
SLAL03A	10" Alcohol Wok Set	SET	58.42	1	24	6.33
SLAL04A	11" Alcohol Wok Set	SET	62.83	1	24	8.20
SLAL01B	7½" Alcohol Wok Body	EACH	59.40	6	72	5.09
SLAL02B	9" Alcohol Wok Body	EACH	68.30	6	48	5.03
SLAL03B	10" Alcohol Wok Body	EACH	68.34	6	48	4.87
SLAL04B	11" Alcohol Wok Body	EACH	77.16	6	48	6.43
SLAL005	Alcohol Wok Base	EACH	48.50	1	80	5.01



SLFD001, SLFD002

OVAL FISH PLATTER

Wok set comes with oval steel platter. Lever handle allows easy control of flames.



ITEM	DESCRIPTION	U/M	WEIGHT GROSS lbs	INNER PACK	MASTER PACK	CU. FT.
SLFD001	14"	EACH	57.76	1	24	9.86
SLFD002	16"	EACH	69.22	1	24	13.02



SLFM001

CHAFING WOK SET

Steel wok set comes with lid and base. Heating compartment to keep meals hot.

ITEM	DESCRIPTION	U/M	WEIGHT GROSS lbs	INNER PACK	MASTER PACK	CU. FT.
SLFM001	7" x 7¼" Wok Set	SET	41.80	1	30	5.50

RICE CONTAINER

Keep your rice warm and moist with an insulated container. Constructed with light weight plastic. Container for rice with lid. Replacement lid also available.

Insulated

ITEM	DESCRIPTION	U/M	WEIGHT GROSS lbs	INNER PACK	MASTER PACK	CU. FT.
T-111	64 oz, Rice Container, w/ handle. Spoon Included	SET	28.00	1	12	2.43
T-111C	Rice Container Cover Fits T-111 and T-333	EACH	32.63	12	72	2.82



Regular

ITEM	DESCRIPTION	U/M	WEIGHT GROSS lbs	INNER PACK	MASTER PACK	CU. FT.
P-222	72 oz, 7½" Rice Container	SET	19.25	1	12	2.67
T-333	72 oz, Rice Container w/ handle. Spoon Included	SET	21.61	1	12	2.35



RICE SCOOP

A simple hand tool for scooping rice from container. Durable and easy to clean.

ITEM	DESCRIPTION	U/M	WEIGHT GROSS lbs	INNER PACK	MASTER PACK	CU. FT.
PLRS001	Plastic Rice Scoop	EACH	33.07	50	500	1.55
PLRS003	10½" Plastic Jumbo Rice Scoop	EACH	21.67	24	120	1.79



PHO BOWL – MELAMINE



Ivory

ITEM	DESCRIPTION	U/M	WEIGHT GROSS lbs	INNER PACK	MASTER PACK	CU. FT.
PH5005V	19 oz, 5⅞" x 2¼"	DOZEN	37.25	1	6	1.65
PH5007V	38 oz, 7⅞" x 2¾"	DOZEN	38.06	1	4	2.26
PH5008V	58 oz, 8¼" x 3¼"	DOZEN	42.02	1	3	3.16
PH5010V	88 oz, 9¼" x 3⅞"	DOZEN	46.95	1	2	2.78



White

ITEM	DESCRIPTION	U/M	WEIGHT GROSS lbs	INNER PACK	MASTER PACK	CU. FT.
PH5005TW	19 oz, 5⅞" x 2¼"	DOZEN	37.25	1	6	1.65
PH5007TW	38 oz, 7⅞" x 2¾"	DOZEN	38.06	1	4	2.26
PH5008TW	58 oz, 8¼" x 3¼"	DOZEN	42.02	1	3	3.16
PH5010TW	88 oz, 9¼" X 3⅞"	DOZEN	46.95	1	2	2.78





10" Red



12" Blue



14" Light Green



16" Red

FISH PLATTER (MELAMINE)

Festive fish shaped platter.



ITEM	DESCRIPTION	U/M	WEIGHT GROSS lbs	INNER PACK	MASTER PACK	CU. FT.
1000CFB	10" - Blue	DOZEN	19.11	0.5	3	1.47
1000CFG	10" - Light Green	DOZEN	19.11	0.5	3	1.47
1000CFR	10" - Red	DOZEN	19.11	0.5	3	1.47
1200CFB	12" - Blue	DOZEN	26.04	0.5	3	2.12
1200CFG	12" - Light Green	DOZEN	26.04	0.5	3	2.12
1200CFR	12" - Red	DOZEN	26.04	0.5	3	2.12
1400CFB	14" - Blue	DOZEN	30.03	0.25	2	2.97
1400CFG	14" - Light Green	DOZEN	30.03	0.25	2	2.97
1400CFR	14" - Red	DOZEN	30.03	0.25	2	2.97
1600CFB	16" - Blue	DOZEN	38.85	0.25	2	3.90
1600CFG	16" - Light Green	DOZEN	38.85	0.25	2	3.90
1600CFR	16" - Red	DOZEN	38.85	0.25	2	3.90

JAPANESE LANTERN

Festive lanterns for decoration. 16" diameter.



HL-22



HL-23



HL36-2

ITEM	DESCRIPTION	U/M	WEIGHT GROSS lbs	INNER PACK	MASTER PACK	CU. FT.
HL-22	Red, Fortune	EACH	22.46	12	96	5.88
HL-23	Red, Longevity	EACH	22.46	12	96	5.88
HL36-2	Geisha	EACH	30.29	12	96	9.88

WELCOME MAT

Festive red mat to invite guests. Works in all kinds of weather.

ITEM	DESCRIPTION	U/M	WEIGHT GROSS lbs	INNER PACK	MASTER PACK	CU. FT.
PLWC001	54" x 34" Welcome Mat	EACH	70.40	12	12	4.00



PLWC001



CHOPSTICKS

Bag sealed chopsticks. Made of selective bamboo, plastics and melamine for various choices. 1,000 Pairs/Case

ITEM	DESCRIPTION	U/M	WEIGHT GROSS lbs	INNER PACK	MASTER PACK	CU. FT.
BACS002	45 cm Long Chopsticks	PAIR	22.05	50	500	2.07
PLCS001	Dragon Chopsticks	CASE	66.00	1	1	1.11
PLCS002	White Chopsticks	CASE	66.00	1	1	1.11
PLCS003	Red Chopsticks	CASE	66.00	1	1	1.11
MLCS001	Melamine Chopsticks White	CASE	66.00	1	1	1.10
MLCS002	Melamine Chopsticks Yellow	CASE	66.00	1	1	1.10
MLCS001B	Melamine Chopsticks Black	CASE	66.00	1	1	1.10
MLCS001G	Melamine Chopsticks Green	CASE	66.00	1	1	1.10



BACS002

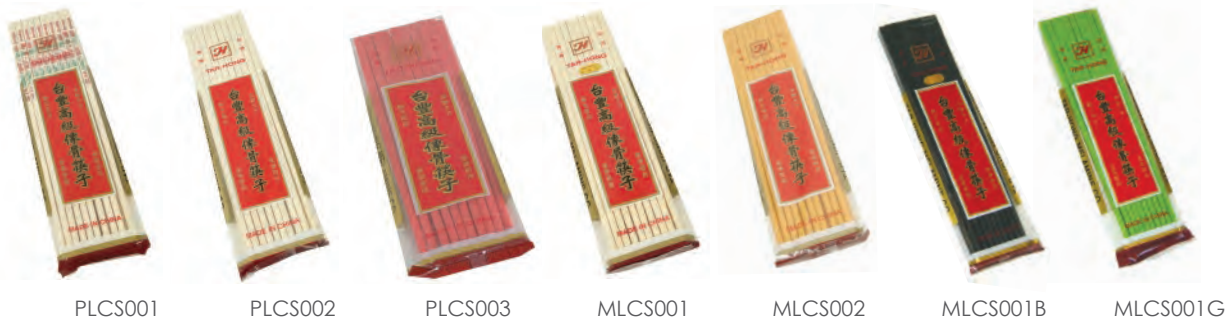

PLCS001

PLCS002

PLCS003

MLCS001

MLCS002

MLCS001B

MLCS001G

*Sold by Master Pack Only

CHOPSTICKS HOLDER

Plastic vertical chopstick holders. Available in black, ivory, and stainless steel.

ITEM	DESCRIPTION	U/M	WEIGHT GROSS lbs	INNER PACK	MASTER PACK	CU. FT.
PLCH001-B	Black	EACH	28.60	1	24	3.20
PLCH001-I	Ivory	EACH	28.60	1	24	3.20
SLCH007	Stainless Steel	EACH	37.48	1	24	2.81



PLCH001-B



PLCH001-I



SLCH007

SUSHI ROLLER

Bamboo rolling tool for Sushi hand rolls. Compact and easy to use.

ITEM	DESCRIPTION	U/M	WEIGHT GROSS lbs	INNER PACK	MASTER PACK	CU. FT.
BASR095JP	9½" x 9½" - Flat	EACH	44.09	10	200	1.63
BASR195JP	9½" x 9½" - Round	EACH	24.25	10	200	1.54



BASR095JP



BASR195JP



BASR095JP



BASR195JP



Pizza Supplies

- Dough Boxes p. 258
- Pizza Tray p. 209
- Pizza Peels p. 210
- Pizza Screen p. 209
- Pizza Bags p. 210
- Pizza Stands p. 337
- Cheese Dispenser p. 330
- Pizza Cutter p. 210
- Pan Grip p. 210

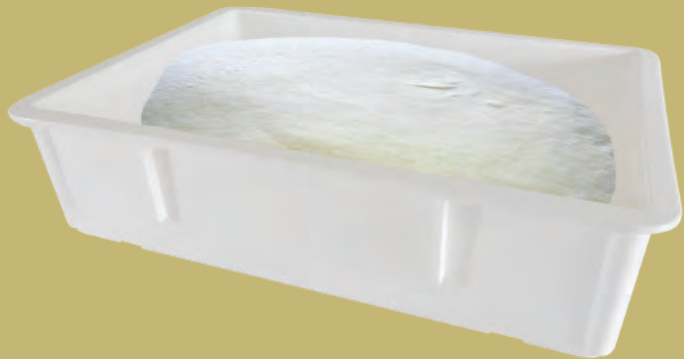



BAKEWARE & SUPPLIES

2024

ALBA0214



ALBA0312



Handles



BAKE PAN

A ALUMINUM

ITEM	DESCRIPTION	U/M	WEIGHT GROSS lbs	INNER PACK	MASTER PACK	CU. FT.
ALBA0214	26¼" x 18¼" x 2¼"	EACH	44.98	1	12	1.79
ALBA0312	26¼" x 18¼" x 3¼" with Handles	EACH	30.87	1	6	2.48

CARBON STEEL NON-STICK



SLKMP012



SLKMP024



SLKMP124

ALUMINUM



ALKMP012

MUFFIN PAN

Multiple usage include food storage and food preparation. Smooth surface for easy cleaning and maintenance.

ITEM	DESCRIPTION	U/M	WEIGHT GROSS lbs	INNER PACK	MASTER PACK	CU. FT.
Aluminum						
ALKMP012	3½ oz, 12 cup	EACH	31.97	12	24	1.40
ALKMP024	3½ oz, 24 cup	EACH	26.00	12	12	1.44
Carbon Steel, Non-Stick						
SLKMP012	3½ oz, 12 cup	EACH	28.66	1	24	1.41
SLKMP024	3½ oz, 24 cup	EACH	30.78	1	12	2.00
SLKMP124	1½ oz, 24 cup	EACH	28.66	1	24	1.37



ALKMP024

BAKEWARE & SUPPLIES

199

SHEET PAN

With galvanized wire, perfect for all baking needs.



ALSP1813PF



ALSP1826PF



ALSP1813PG



ALSP1826
ALSP1826M
ALSP1826H
ALSP1826S



ALSP1622



ALSP1813



ALSP1826PG

TRUE GAUGE



ITEM	DESCRIPTION	U/M	WEIGHT GROSS lbs	INNER PACK	MASTER PACK	CU. FT.
ALSP1006	10" x 6" Eighth Size	EACH	40.73	12	72	1.43
ALSP1013	9½" x 13" Quarter Size	EACH	26.06	24	24	0.78
ALSP1622	16" x 22" Two-thirds Size	EACH	25.31	12	12	1.34
ALSP1813	18" x 13" Half Size	EACH	20.06	12	12	0.86
ALSP1826	18" x 26" Full Size	EACH	34.70	12	12	1.91
ALSP1826M	18" x 26" Full Size Pan	EACH	38.08	12	12	1.91
ALSP1826H	18" x 26" Full Size Pan	EACH	42.97	12	12	1.91
ALSP1826S	18" x 26" Full Size Pan	EACH	55.93	12	12	1.94



ALSP1006



ALSP1013

Perforated

ALSP1813PF	18" x 13" Half Size, Perforated	EACH	19.75	12	12	0.86
ALSP1826PF	18" x 26" Full Size, Perforated	EACH	34.61	12	12	1.91
ALSP1813PG	18" x 13" Half Size, Fully Perforated	EACH	20.98	12	12	0.94
ALSP1826PG	18" x 26" Full Size, Fully Perforated	EACH	35.48	12	12	1.91
ALSP1826HPF	18" x 26" Perforated Full Size Pan	EACH	39.50	12	12	1.91

*Fully Perforated



Non-Stick

ALSP1813D	18" x 13" Half Size	EACH	23.44	12	12	0.94
ALSP1826D	18" x 26" Full Size	EACH	39.32	12	12	1.91

*Non-Stick Coating



ALSP1813D



ALSP1826D

SHEET PAN

Open bead edge is easy to clean.



ITEM	DESCRIPTION	U/M	WEIGHT GROSS lbs	INNER PACK	MASTER PACK	CU. FT.
SLSP1813	18" x 13" Half Size Sheet, 18/8 Stainless Steel	EACH	17.46	6	6	0.46
SLSP1826	18" x 26" Full Size Sheet, 18/8 Stainless Steel	EACH	35.36	6	6	1.02



*open bead design

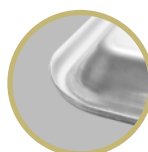

SHEET PAN COVER – POLYPROPYLENE

ITEM	DESCRIPTION	U/M	WEIGHT GROSS lbs	INNER PACK	MASTER PACK	CU. FT.
PLSP1013C	9½" x 13" Quarter Size	EACH	10.34	12	24	1.32
PLSP1813C	18" x 13" Half Size	EACH	25.00	12	36	2.34
PLSP1826C	18" x 26" Full Size	EACH	45.00	12	36	5.86



(Cover & Pan are sold separately)



PLSP1826C



PLSP1813C



PLSP1013C

ALUMINUM SHEET PAN TRUCK

- 14 gauge 6063 aluminum with 1" extruded aluminum tube frame
- Full swivel casters 5" diameter x 1¼" width
- Capacity: up to 54 full size (18" x 26") or 108 half size (18" x 13") sheet pans
- Overall Size 20¾" W x 28¼" D x 33⅜" H
- Ships knocked down



ALSC1826

Sheet Pans Sold Separately



PLCB5150



ITEM	DESCRIPTION	U/M	WEIGHT GROSS lbs	INNER PACK	MASTER PACK	CU. FT.
ALSC1826	Full Size Aluminum Sheet Pan Truck w/four 5" Swivel Casters	SET	22.66	1	1	1.87
PLCB5150	Replacement 5" Swivel Caster For ALSC1826	EACH	28.11	1	18	1.41

PAN RACK

Rack with cross supports.
 10 tier rack holds 10 full-size pans, or 20 half-size pans.
 20 tier rack holds 20 full-size pans, or 40 half-size pans.
 2 large locking casters and 2 regular casters for easy transport are included.
 Clear cover is also available separately.



ITEM	DESCRIPTION	U/M	WEIGHT GROSS lbs	INNER PACK	MASTER PACK	CU. FT.
ALSPR010	10-Tier 20¼" x 26" x 38½"	SET	20.64	1	1	2.26
ALSPR020	20-Tier 20¼" x 26" x 69¼"	SET	32.86	1	1	4.18
Pan Rack Accessories						
PLRC005	5" Caster	EACH	16.70	1	12	0.50
PLRC005B	5" Locking Caster	EACH	19.28	1	12	0.59
PLPRC020	20-Tier Pan Rack Cover - Clear	EACH	49.20	1	12	1.85

*** Shipped Freight Only - No UPS ***



DOUGH PAN/ PIE PAN



ALDP048
ALDP048c
ALDP096
ALDP096c



ALPN009
ALPN010
ALPN011
ALPN012



ITEM	DESCRIPTION	U/M	WEIGHT GROSS lbs	INNER PACK	MASTER PACK	CU. FT.
Dough Pan						
ALDP048	48 oz Dough Pan, 8" Diameter x 2½" Stackable	EACH	27.31	12	48	5.04
ALDP048C	Dough Pan Cover For ALDP048,	EACH	26.72	12	120	1.34
ALDP096	96 oz Dough Pan, 9" Diameter x 3¾" Stackable	EACH	28.31	12	48	7.01
ALDP096C	Dough Pan Cover For ALDP096,	EACH	34.26	12	120	1.70
Pie Pan						
ALPN009	9" Pie Pan	EACH	31.38	12	72	1.75
ALPN010	10" Pie Pan	EACH	34.71	12	72	2.31
ALPN011	11" Pie Pan	EACH	41.05	12	72	2.49
ALPN012	12" Pie Pan	EACH	49.17	12	72	2.92

PIE MARKER

Portion control. For pie or cake cutting.



ALPMA008

ITEM	DESCRIPTION	U/M	WEIGHT GROSS lbs	INNER PACK	MASTER PACK	CU. FT.
ALPMA005	5 Cut	EACH	33.07	12	96	8.16
ALPMA006	6 Cut	EACH	34.17	12	96	8.16
ALPMA007	7 Cut	EACH	35.27	12	96	8.16
ALPMA008	8 Cut	EACH	36.38	12	96	8.16
ALPMA009	9 Cut	EACH	38.58	12	96	8.77
ALPMA010	10 Cut	EACH	39.68	12	96	8.77
ALPMA012	12 Cut	EACH	43.50	12	96	8.77

PIE SERVER

Stainless steel blade. Durable and flexible. Sturdy handle made of plastic or wood.

ITEM	DESCRIPTION	U/M	WEIGHT GROSS lbs	INNER PACK	MASTER PACK	CU. FT.
SLTWPS002	6" w/ 3" x 4½" Blade Wood Handle. 11¼" x 3" x 1½"	EACH	40.79	12	120	1.19
SLPS027P	2½" x 4¼" Plastic Handle	EACH	30.86	12	120	1.43



SLTWPS002

SLPS027P

ROUND LAYER CAKE PAN

For creating the perfect multi-layer cake.



ITEM	DESCRIPTION	U/M	WEIGHT GROSS lbs	INNER PACK	MASTER PACK	CU. FT.
2" Pan						
ALCP0302	3" Diameter x 2"	EACH	10.71	12	48	0.99
ALCP0602	6" Diameter x 2"	EACH	12.83	6	36	2.30
ALCP0802	8" Diameter x 2"	EACH	21.66	6	36	5.03
ALCP0902	9" Diameter x 2"	EACH	27.94	6	36	5.51
ALCP1002	10" Diameter x 2"	EACH	29.49	6	36	7.03
ALCP1202	12" Diameter x 2"	EACH	36.79	6	36	9.90
ALCP1402	14" Diameter x 2"	EACH	28.17	6	24	6.78
ALCP1602	16" Diameter x 2"	EACH	33.99	6	24	9.09

Available Size in Diameter
3"
16"



ITEM	DESCRIPTION	U/M	WEIGHT GROSS lbs	INNER PACK	MASTER PACK	CU. FT.
3" Pan						
ALCP0303	3" Diameter x 3"	EACH	13.89	12	48	1.40
ALCP0603	6" Diameter x 3"	EACH	15.21	6	36	3.22
ALCP0803	8" Diameter x 3"	EACH	25.30	6	36	6.54
ALCP0903	9" Diameter x 3"	EACH	27.96	6	36	7.34
ALCP1003	10" Diameter x 3"	EACH	36.44	6	36	9.15
ALCP1203	12" Diameter x 3"	EACH	44.51	6	36	12.87
ALCP1403	14" Diameter x 3"	EACH	31.35	6	24	9.70
ALCP1603	16" Diameter x 3"	EACH	36.64	6	24	12.83

Available Size in Diameter
3"
16"

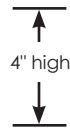

ITEM	DESCRIPTION	U/M	WEIGHT GROSS lbs	INNER PACK	MASTER PACK	CU. FT.
4" Pan						
ALCP1004	10" Diameter x 4"	EACH	13.89	12	48	1.40
ALCP1204	12" Diameter x 4"	EACH	15.21	6	36	3.22
ALCP1404	14" Diameter x 4"	EACH	25.30	6	36	6.54
ALCP1604	16" Diameter x 4"	EACH	27.96	6	36	7.34

Available Size in Diameter
10"
16"



DREDGER

For dispensing flour, sugar and more.



SLRDH001



SLRDH002



ALRDH001



ALRDH002



PLRDH003

ITEM	DESCRIPTION	U/M	WEIGHT GROSS lbs	INNER PACK	MASTER PACK	CU. FT.	
SLRDH001	10 oz with Handle	EACH	22.00	12	72	1.95	STAINLESS STEEL
SLRDH002	10 oz without Handle	EACH	20.79	12	72	1.95	STAINLESS STEEL
ALRDH001	10 oz Dredge With Handle	EACH	19.10	12	144	3.16	ALUMINUM
ALRDH002	10 oz Dredge Without Handle	EACH	16.88	12	144	3.16	ALUMINUM
PLRDH003	10 oz with 3 Snap-On Lids: Fine, Medium & Large Holes. (Polycarbonate Cup with Polypropylene Lid)	SET	25.30	12	72	3.36	POLYCARBONATE

LIQUID MEASURE CUP

With riveted handles. Easy to measure.



ALKAM005



ALKAM010



ALKAM020



ALKAM040



ITEM	DESCRIPTION	U/M	WEIGHT GROSS lbs	INNER PACK	MASTER PACK	CU. FT.
ALKAM005	1/2 qt	EACH	20.30	1	48	3.31
ALKAM010	1 qt	EACH	17.64	1	36	4.10
ALKAM020	2 qt	EACH	20.94	1	24	4.93
ALKAM040	4 qt	EACH	16.71	1	12	4.07

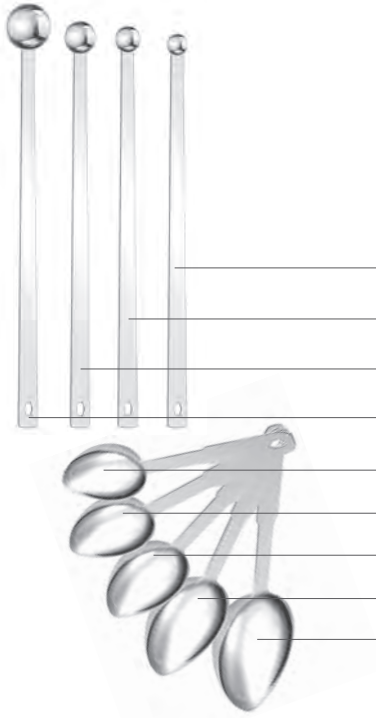

MEASURING SPOON

Measurements comply with U.S. Standards.



ITEM	DESCRIPTION	U/M	WEIGHT GROSS lbs	INNER PACK	MASTER PACK	CU. FT.
SLMS025L	1/4 tsp, 15 3/4" Long	EACH	21.60	12	144	0.53
SLMS050L	1/2 tsp, 15 3/8" Long	EACH	30.00	12	144	0.53
SLMS100L	1 tsp, 15 1/2" Long	EACH	30.80	12	144	0.91
SLMS150L	1 Tbsp, 16" Long	EACH	31.40	12	144	0.91
SLMS013V	1/8 Cup, 8 3/4" Long	EACH	15.70	12	72	0.21
SLMS025V	1/4 Cup, 8 3/4" Long	EACH	18.40	12	72	0.26
SLMS033V	1/3 Cup, 8 3/4" Long	EACH	22.80	12	72	0.38
SLMS050V	1/2 Cup, 10" Long	EACH	26.20	12	72	0.46
SLMS100V	1 Cup, 11" Long	EACH	27.70	12	72	0.67

MEASURING SPOON SET & MEASURING CUP SET

Measurements comply with U.S. Standards.



SLMC2414

ITEM	DESCRIPTION	U/M	WEIGHT GROSS lbs	INNER PACK	MASTER PACK	CU. FT.
SLMC2414	1/4, 1/2, 1 Cup	SET	37.48	12	72	1.59
SLMC2415	1/4, 1/2, 1 tsp, 1 Tbsp	SET	30.75	24	288	0.88
SLMC2416	1/4, 1/2, 1 tsp, 1 Tbsp	SET	48.5	24	288	1.13
OW356	1/4, 1/2, 1 tsp, 1 Tbsp	SET	48.40	24	288	1.13



SLMC2415



SLMC2416



OW356

MEASURING SPOON SET

Measurements comply with U.S. Standards.



ALMC001

ITEM	DESCRIPTION	U/M	WEIGHT GROSS lbs	INNER PACK	MASTER PACK	CU. FT.
ALMC001	1 Tbsp, 1 Tsp, 1/2 Tsp & 1/4 Tsp	SET	23.15	24	288	0.88

Make baking easier with non-stick silicone baking products

- Non-stick high heat silicone
- Flexible and unbreakable
- FDA Approved
- Temperature rated -40° to 550° F



PLBM001S



PLBM002S



PLBM003S



PLBM004S



PLBM005S



SILICONE BAKING MOLD

ITEM	DESCRIPTION	U/M	WEIGHT GROSS lbs	INNER PACK	MASTER PACK	CU. FT.
PLBM001S	2.7 oz, Hemisphere	EACH	14.06	1	48	3.68
PLBM002S	4.4 oz, Heart	EACH	18.82	1	48	5.57
PLBM003S	4.57 oz, Muffin	EACH	15.64	1	48	3.68
PLBM004S	3.89 oz, Dahlia	EACH	16.90	1	48	3.68
PLBM005S	3.89 oz, Sunflower	EACH	18.38	1	48	3.68

SILICONE BAKING MOLD

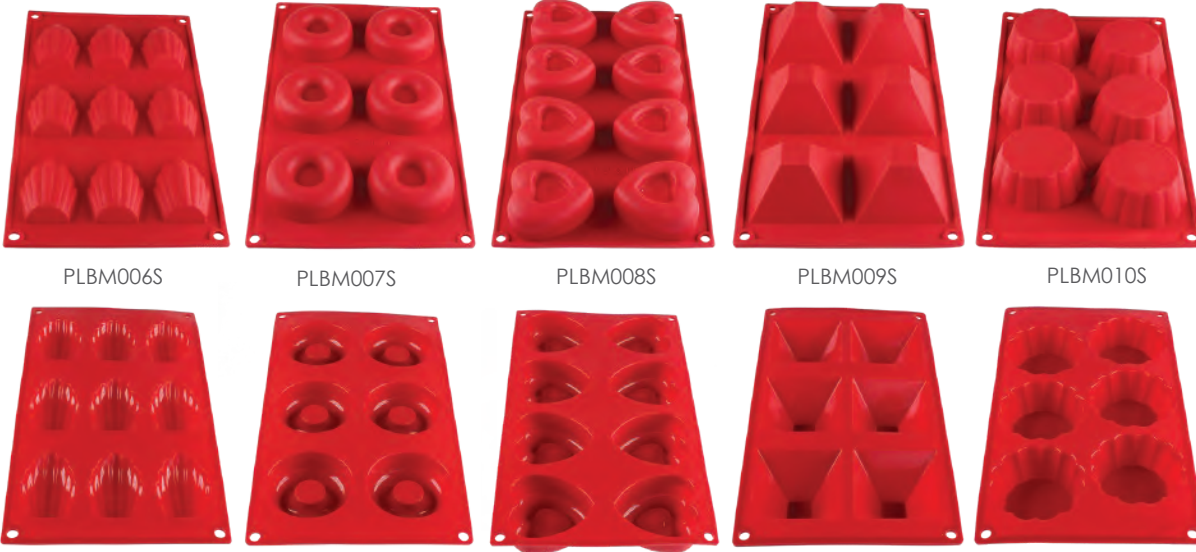

PLBM006S

PLBM007S

PLBM008S

PLBM009S

PLBM010S

ITEM	DESCRIPTION	U/M	WEIGHT GROSS lbs	INNER PACK	MASTER PACK	CU. FT.
PLBM006S	1 oz, Madeleine	EACH	14.14	1	48	2.79
PLBM007S	2.1 oz, Savarin	EACH	13.32	1	48	2.79
PLBM008S	2.4 oz, Heart	EACH	15.11	1	48	3.68
PLBM009S	3 oz, Pyramid	EACH	14.27	1	48	3.68
PLBM010S	3.7 oz, Brioche	EACH	13.00	1	48	3.68

SILICONE BAKING MAT



PLBM0804S

PLBM1108S

PLBM1216S

PLBM1520S

PLBM1624S

ITEM	DESCRIPTION	U/M	WEIGHT GROSS lbs	INNER PACK	MASTER PACK	CU. FT.
PLBM0804S	4 $\frac{3}{4}$ " x 8 $\frac{3}{4}$ " Rectangular, Fits $\frac{1}{8}$ Sheet Pan	EACH	10.32	12	48	0.11
PLBM1108S	8 $\frac{1}{4}$ " x 11 $\frac{3}{4}$ " Rectangular, Fits $\frac{1}{4}$ Sheet Pan	EACH	13.49	12	48	0.74
PLBM1216S	11 $\frac{7}{8}$ " x 16 $\frac{1}{2}$ " Rectangular, Fits $\frac{1}{2}$ Sheet Pan	EACH	19.52	12	48	1.45
PLBM1520S	14 $\frac{5}{8}$ " x 20 $\frac{1}{2}$ " Rectangular, Fits $\frac{3}{8}$ Sheet Pan	EACH	25.98	12	48	1.75
PLBM1624S	16 $\frac{1}{2}$ " x 24 $\frac{1}{2}$ " Rectangular, Fits $\frac{1}{2}$ Sheet Pan	EACH	34.76	12	48	1.97

PIZZA TRAY & PIZZA SCREEN



ALUMINUM

Wide Rim
ALPTWR008 ~ ALPTWR022



Seamless Rim
ALPZ08 ~ ALPZ22



Coupe Style
ALPTCS008 ~ ALPTCS018



ITEM	DESCRIPTION	U/M	WEIGHT GROSS lbs	INNER PACK	MASTER PACK	CU. FT.
Pizza Tray						
ALPTWR008	8" Wide Rim Tray	EACH	40.79	12	168	1.70
ALPTWR009	9" Wide Rim Tray	EACH	50.04	12	168	2.04
ALPTWR010	10" Wide Rim Tray	EACH	61.73	12	168	2.50
ALPTWR011	11" Wide Rim Tray	EACH	72.75	12	168	2.98
ALPTWR012	12" Wide Rim Tray	EACH	61.07	12	120	2.77
ALPTWR013	13" Wide Rim Tray	EACH	28.66	12	48	1.25
ALPTWR014	14" Wide Rim Tray	EACH	33.07	12	48	1.40
ALPTWR015	15" Wide Rim Tray	EACH	39.24	12	48	1.72
ALPTWR016	16" Wide Rim Tray	EACH	44.09	12	48	1.81
ALPTWR017	17" Wide Rim Tray	EACH	49.16	12	48	2.16
ALPTWR018	18" Wide Rim Tray	EACH	56.88	12	48	2.36
ALPTWR019	19" Wide Rim Tray	EACH	31.53	12	24	1.59
ALPTWR020	20" Wide Rim Tray	EACH	34.61	12	24	1.75
ALPTWR022	22" Wide Rim Tray	EACH	41.89	12	24	2.07
Pizza Screen						
ALPZ08	8" Seamless Rim Screen	EACH	24.25	12	168	1.30
ALPZ09	9" Seamless Rim Screen	EACH	28.66	12	168	1.67
ALPZ10	10" Seamless Rim Screen	EACH	33.07	12	168	1.97
ALPZ11	11" Seamless Rim Screen	EACH	37.48	12	168	2.34
ALPZ12	12" Seamless Rim Screen	EACH	27.60	12	120	2.82
ALPZ13	13" Seamless Rim Screen	EACH	15.40	12	48	0.97
ALPZ14	14" Seamless Rim Screen	EACH	15.84	12	48	1.27
ALPZ15	15" Seamless Rim Screen	EACH	16.72	12	48	1.37
ALPZ16	16" Seamless Rim Screen	EACH	18.48	12	48	1.54
ALPZ17	17" Seamless Rim Screen	EACH	20.33	12	48	1.61
ALPZ18	18" Seamless Rim Screen	EACH	22.13	12	48	2.24
ALPZ19	19" Seamless Rim Screen	EACH	14.00	12	24	1.12
ALPZ20	20" Seamless Rim Screen	EACH	14.99	12	24	1.24
ALPZ22	22" Seamless Rim Screen	EACH	15.00	12	24	1.53
Coupe Tray						
ALPTCS008	8" Coupe Style Tray	EACH	40.74	12	168	1.79
ALPTCS009	9" Coupe Style Tray	EACH	49.69	12	168	2.08
ALPTCS010	10" Coupe Style Tray	EACH	60.80	12	168	2.51
ALPTCS011	11" Coupe Style Tray	EACH	72.53	12	168	3.05
ALPTCS012	12" Coupe Style Tray	EACH	61.07	12	120	2.63
ALPTCS013	13" Coupe Style Tray	EACH	28.57	12	48	1.41
ALPTCS014	14" Coupe Style Tray	EACH	32.54	12	48	1.49
ALPTCS015	15" Coupe Style Tray	EACH	37.39	12	48	1.69
ALPTCS016	16" Coupe Style Tray	EACH	41.71	12	48	1.82
ALPTCS017	17" Coupe Style Tray	EACH	46.83	12	48	1.99
ALPTCS018	18" Coupe Style Tray	EACH	51.37	12	48	2.22



PLPB018

PIZZA BAG

Insulated bag with Velcro fasteners and holes for ventilation. The exterior is made out of durable Leatheroid PVC (a synthetic leather) with nylon edges. The interior is constructed of 1" foam insulation for better heat retention. T-strap for easy handling.

ITEM	DESCRIPTION	U/M	WEIGHT GROSS lbs	INNER PACK	MASTER PACK	CU. FT.
PLPB018	18" x 18" Holds 2 of 16" Pizza	EACH	17.42	1	12	4.58
PLPB020	20" x 20" Holds 2 of 18" Pizza	EACH	21.16	1	12	5.56
PLPB024	24" x 24" Holds 2 of 22" Pizza	EACH	27.78	1	12	7.81



PIZZA PEEL

Endures heat, scrubbing, and other harsh treatment. Surface area withstands bending and offers a reliable support.

ITEM	DESCRIPTION	U/M	WEIGHT GROSS lbs	INNER PACK	MASTER PACK	CU. FT.
Aluminum with Wood Handle						
ALWDPP2512	12" x 14" Blade, 25" Overall Length, 12" Handle	EACH	27.94	12	24	1.51
ALWDPP3012	12" x 14" Blade, 30" Overall Length, 16 ⁷ / ₈ " Handle	EACH	31.90	12	24	1.87
ALWDPP3512	12" x 14" Blade, 35" Overall Length, 22" Handle	EACH	34.40	12	24	2.14
ALWDPP5212	12" x 14" Blade, 52" Overall Length, 38" Handle	EACH	38.50	12	24	2.98
Wood						
WDPP1222	12" x 14" Blade, 22" Overall Length, 8 ³ / ₄ " Handle	EACH	19.84	1	12	0.98
WDPP1236	12" X 14" Blade, 36" Overall Length, 22 ¹ / ₄ " Handle	EACH	28.66	1	12	1.61
WDPP1242	12" X 14" Blade, 42" Overall Length, 28 ³ / ₈ " Handle	EACH	29.98	1	12	1.87
WDPP1424	14" x 16" Blade, 24" Overall Length, 8 ³ / ₈ " Handle	EACH	30.86	1	12	1.26
WDPP1436	14" x 16" Blade, 36" Overall Length, 20 ³ / ₈ " Handle	EACH	33.95	1	12	1.82
WDPP1442	14" x 16" Blade, 42" Overall Length, 26 ³ / ₈ " Handle	EACH	35.27	1	12	2.18
WDPP1642	16" x 18" Blade, 42" Overall Length, 24 ¹ / ₄ " Handle	EACH	22.05	1	6	1.25
WDPP1842	18" x 18" Blade, 42" Overall Length, 22 ¹ / ₈ " Handle	EACH	47.18	1	12	2.78
WDPP2042	20" x 21" Blade, 42" Overall Length, 20 ¹ / ₈ " Handle	EACH	28.66	1	6	1.56

PIZZA ACCESSORIES



ITEM	DESCRIPTION	U/M	WEIGHT GROSS lbs	INNER PACK	MASTER PACK	CU. FT.
Pizza Server						
SLTWPS005	3" x 4 ¹ / ₄ " Blade Wood Handle, 10" x 2 ¹ / ₄ " x 2 ¹ / ₄ "	EACH	39.00	12	180	1.25
SLTWPS006	2 ¹ / ₂ " x 5" Blade Wood Handle, 10 ¹ / ₄ " x 2 ¹ / ₁₆ " x 1 ¹ / ₄ "	EACH	30.64	12	144	0.89
Pizza Cutter						
SLTWPC002	2 ¹ / ₂ " Wheel Plastic Handle, 8 ³ / ₄ " x 3 ³ / ₄ " x 7 ⁸ / ₈ "	EACH	42.90	12	120	1.18
SLTWPC004	4" Wheel Plastic Handle, 9 ¹ / ₄ " x 4 ¹ / ₂ " x 7 ⁸ / ₈ "	EACH	44.09	12	120	2.05
Pan Grips						
ALPG008H	Heavy Duty, Aluminum, 7 ⁷ / ₈ " x 1 ¹ / ₄ " x 6 ¹ / ₂ "	EACH	18.80	12	48	0.78
SLPG008D	For Deep Dish, Steel, 7 ³ / ₈ " x 1 ¹ / ₂ " x 2 ³ / ₄ "	EACH	22.70	6	60	0.95
SLPG008S	For Shallow Pan, Steel, 7 ⁷ / ₈ " x 1 ¹ / ₂ " x 2 ³ / ₄ "	EACH	22.50	6	60	0.97

ROLLING PIN

ITEM	DESCRIPTION	U/M	WEIGHT GROSS lbs	INNER PACK	MASTER PACK	CU. FT.
Aluminum						
ALRNP013	13"	EACH	22.90	1	6	1.02
ALRNP015	15"	EACH	28.50	1	6	1.14
ALRNP018	18"	EACH	33.00	1	6	1.28
Wood						
WDRNP013	13"	EACH	17.60	1	6	0.84
WDRNP015	15"	EACH	18.52	1	6	0.93
WDRNP018	18"	EACH	24.03	1	6	1.01

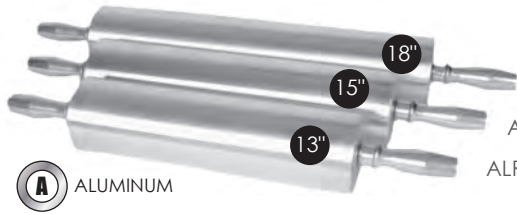

ALRNP018
ALRNP015
ALRNP013



WDRNP018
WDRNP015
WDRNP013

FLOUR SIFTER

Mirror-finished body made of stainless steel. Four wire agitator to properly sift flour.



ITEM	DESCRIPTION	U/M	WEIGHT GROSS lbs	INNER PACK	MASTER PACK	CU. FT.
SLFS008	8 Cup	EACH	16.29	1	12	3.25



SLFS008

ROLLER DOCKER

Professional rolling docker with sanitary stainless steel handle. Plastic barrel with securely mounted pins.



ITEM	DESCRIPTION	U/M	WEIGHT GROSS lbs	INNER PACK	MASTER PACK	CU. FT.
SLRD008	Plastic Barrel, 8 Wheels	EACH	25.35	1	24	1.98
SLRD020	Half Size Plastic Barrel 3/8" Stainless Pin	EACH	19.84	1	24	1.43
SLRD038	Plastic Barrel, 3/8" Stainless Pin	EACH	28.66	1	24	1.96

SLRD008
4 7/8" Wide Barrel
x 2 3/8"

SLRD020
3 1/4" Wide Barrel
x 2 1/2"

SLRD038
5 3/8" Wide Barrel
x 2 1/2"

ADJUSTABLE DOUGH DIVIDER & CROISSANT CUTTER

Made of stainless steel. The dough dividers can be locked for constant widths.

ITEM	DESCRIPTION	U/M	WEIGHT GROSS lbs	INNER PACK	MASTER PACK	CU. FT.
Adjustable Dough divider						
SLADD05	5-Wheel	EACH	41.89	1	36	1.75
SLADD06	6-Wheel	EACH	42.99	1	36	2.00
Croissant Cutter						
CRCCT038	Cutter Size: 8 1/4" x 3 3/4" x 3 3/4"	EACH	30.80	1	20	4.40



SLADD05



SLADD06



CRCCT038

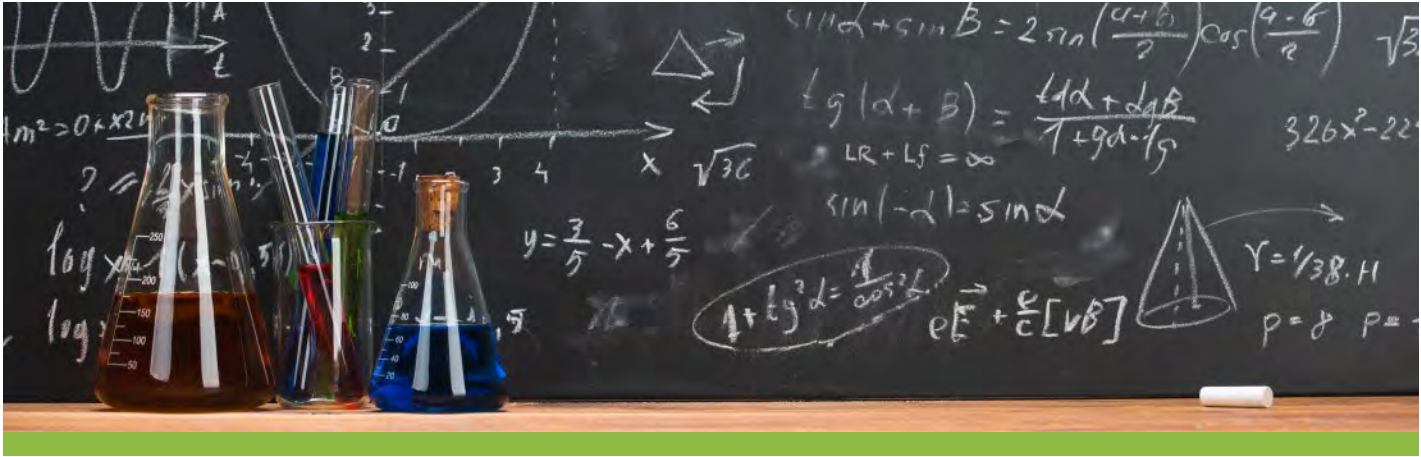

What is Polycarbonate?

Polycarbonate is a clear, durable, shatterproof material that is known for its impact resistance. Polycarbonate made materials are far stronger than those made from acrylic. It's used in applications which demand high performance properties such as in bulletproof windows, riot shields, eyewear lenses etc. This thermoplastic polymer has a highly transparency and refractive index and it has better light transmission characteristics than many conventional glasses.

Bring in the polycarbonate material into Foodservice industry, Thunder Group make public of this unique, elegant & stylish line back in 2009, which brings a new twist to professionals in the foodservice industry, flipping the concept of the traditional glassware in commercial environment. Polycarbonate drinkware looks and feels like glass, but, it is not glass. Its usage provides a perfect upscale dining experience while entertaining with friends and family in a safe environment indoor or outdoor. It also adds to the cost-saving in night clubs and bars' operational side in the long run because breakage will never be a concern or turn into a lawsuit for foodservice operators.

Starburst Pattern

- Crystal clear glass-like
- One-piece molding process
- Durable quality eliminating weak joints
- Shatter and break resistant
- Patented design
- Cold drink (10° C / 50° F) use only





STACKABLE



PLTHRG212C

ROCKS GLASS

ITEM	DESCRIPTION	U/M	WEIGHT GROSS lbs	INNER PACK	MASTER PACK	CU. FT.
PLTHRG208C	8 oz, 3 1/4"	EACH	6.56	12	24	0.76
PLTHRG210C	10 oz, 3 5/8"	EACH	8.34	12	24	0.92
PLTHRG212C	12 oz, 3 3/4"	EACH	10.00	12	24	1.12



STACKABLE

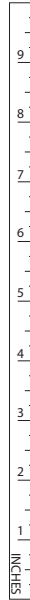

PLTHST214C

HIGHBALL GLASS

ITEM	DESCRIPTION	U/M	WEIGHT GROSS lbs	INNER PACK	MASTER PACK	CU. FT.
PLTHST212C	12 oz, 5 1/2"	EACH	10.50	12	24	1.21
PLTHST214C	14 oz, 6 1/8"	EACH	12.00	12	24	1.49



PLTHPS013C



PLTHPS023C

PILSNER GLASS

ITEM	DESCRIPTION	U/M	WEIGHT GROSS lbs	INNER PACK	MASTER PACK	CU. FT.
PLTHPS013C	13 oz, 8 1/4"	EACH	9.90	12	24	1.42
PLTHPS023C	23 oz, 10"	EACH	8.50	12	12	0.81

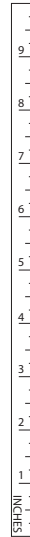

PLPCM001

BEER MUG

ITEM	DESCRIPTION	U/M	WEIGHT GROSS lbs	INNER PACK	MASTER PACK	CU. FT.
PLPCM001	16 oz, 6 1/4"	EACH	16.32	24	24	1.16



PLTHMG016C



PLTHMG020C

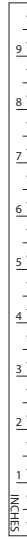

PINT GLASS

ITEM	DESCRIPTION	U/M	WEIGHT GROSS lbs	INNER PACK	MASTER PACK	CU. FT.
PLTHMG016C	16 oz, 6"	EACH	11.46	12	24	1.24
PLTHMG020C	20 oz, 6¾"	EACH	12.41	12	24	1.52



PLTHEP016C



PLTHEP020C

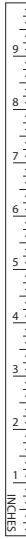

ENGLISH PUB GLASS

ITEM	DESCRIPTION	U/M	WEIGHT GROSS lbs	INNER PACK	MASTER PACK	CU. FT.
PLTHEP016C	16 oz, 6¼"	EACH	10.50	12	24	1.24
PLTHEP020C	20 oz, 6½"	EACH	12.00	12	24	1.49



PLTHWP015C

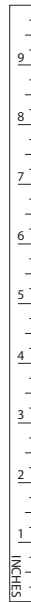

WATER PITCHER w/STARBURST BASE

ITEM	DESCRIPTION	U/M	WEIGHT GROSS lbs	INNER PACK	MASTER PACK	CU. FT.
PLTHWP015C	1.5 liter / 51oz, 9½"	EACH	4.81	1	3	0.86
PLTHWP020C	2 liter / 68oz, 10½"	EACH	6.08	1	3	1.08



PLWP032CL

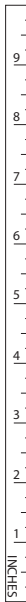

WATER PITCHER w/THREE SPOUTS

ITEM	DESCRIPTION	U/M	WEIGHT GROSS lbs	INNER PACK	MASTER PACK	CU. FT.
PLWP032CL	32 oz Water Pitcher (Three Spouts)	EACH	4.81	12	12	0.90
PLWP064CL	64 oz Water Pitcher (Three Spouts)	EACH	9.37	12	12	1.79



Heavy Base Style

STACKABLE PYRAMID



PLTHRG010C

CLASSIC ROCKS GLASS

ITEM	DESCRIPTION	U/M	WEIGHT GROSS lbs	INNER PACK	MASTER PACK	CU. FT.
PLTHRG008C	8½ oz, 3¼"	EACH	8.04	12	24	0.71
PLTHRG010C	10 oz, 3½"	EACH	9.08	12	24	0.78
PLTHRG012C	12 oz, 3¾"	EACH	9.82	12	24	0.85

Heavy Base Style

STACKABLE PYRAMID

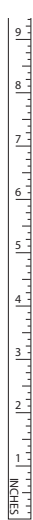

PLTHST012C

CLASSIC HIGHBALL

ITEM	DESCRIPTION	U/M	WEIGHT GROSS lbs	INNER PACK	MASTER PACK	CU. FT.
PLTHST012C	12 oz, 5½"	EACH	6.06	12	24	0.86
PLTHST014C	14 oz, 6½"	EACH	6.80	12	24	0.98

Heavy Base Style

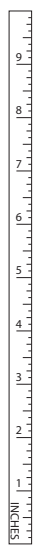

PLTHSG002AC

PLTHSG130SC
PLTHSG125SC

SHOT GLASS

ITEM	DESCRIPTION	U/M	WEIGHT GROSS lbs	INNER PACK	MASTER PACK	CU. FT.
PLTHSG002AC	2 oz Flair, 3¾"	EACH	20.30	24	144	2.07
PLTHSG125SC	2½ oz Square, 2½"	EACH	17.95	24	144	1.08
PLTHSG130SC	3 oz Square, 2½"	EACH	29.10	24	144	1.35

Heavy Base Style

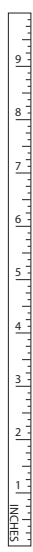

PLTHSG001CC
PLTHSG015CC
PLTHSG002CC

SHOT GLASS

ITEM	DESCRIPTION	U/M	WEIGHT GROSS lbs	INNER PACK	MASTER PACK	CU. FT.
PLTHSG001CC	1 oz Round, 2½"	EACH	17.10	24	144	0.89
PLTHSG015CC	1½ oz Round, 3¼"	EACH	21.00	24	144	1.27
PLTHSG002CC	2 oz Round, 4¼"	EACH	23.79	24	144	1.36

Heavy Base Style



PLTHBK140C

ICE BUCKET

ITEM	DESCRIPTION	U/M	WEIGHT GROSS lbs	INNER PACK	MASTER PACK	CU. FT.
PLTHBK040C	4 qt - 8" Diameter, 8 1/2"H	EACH	11.46	1	6	2.38
PLTHBK140C	4 qt - 8" Diameter with 6" Clear PC Tong	EACH	11.84	1	6	2.38

Heavy Base Style



PLTHCG008C

PLTHFT005C

COCKTAIL GLASS / FRUIT TRAY

ITEM	DESCRIPTION	U/M	WEIGHT GROSS lbs	INNER PACK	MASTER PACK	CU. FT.
PLTHCG008C	8 oz, 3 3/4"	EACH	8.27	12	24	0.79
PLTHFT005C	5 oz, 5" Diameter x 2" Tall	EACH	8.51	12	48	1.37



PLTHMR009C

MARGARITA GLASS

ITEM	DESCRIPTION	U/M	WEIGHT GROSS lbs	INNER PACK	MASTER PACK	CU. FT.
PLTHMR009C	9 oz	EACH	7.24	12	12	2.11
PLTHMR009C	11 oz	EACH	8.14	12	12	2.62



PLTHMT008C

MARTINI GLASS

ITEM	DESCRIPTION	U/M	WEIGHT GROSS lbs	INNER PACK	MASTER PACK	CU. FT.
PLTHMT008C	8 oz, 6 1/2"	EACH	8.86	12	24	2.54

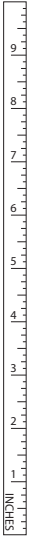

PLTHHC016C PLTHHC024C

HURRICANE GLASSES

ITEM	DESCRIPTION	U/M	WEIGHT GROSS lbs	INNER PACK	MASTER PACK	CU. FT.
PLTHHC016C	16 oz, 8"	EACH	8.29	12	24	1.54
PLTHHC024C	24 oz, 9 1/4"	EACH	11.77	12	24	2.05

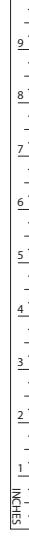

PLTHGL020C

GOBLET

ITEM	DESCRIPTION	U/M	WEIGHT GROSS lbs	INNER PACK	MASTER PACK	CU. FT.
PLTHGL020C	20 oz, 7 3/4"	EACH	10.50	12	24	1.59

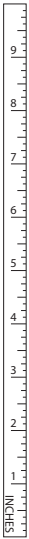

PLTHCP007C



PLTHWG011RC PLTHWG014RC



PLTHWG023RC PLTHWG025RC

CHAMPAGNE

ITEM	DESCRIPTION	U/M	WEIGHT GROSS lbs	INNER PACK	MASTER PACK	CU. FT.
PLTHCP007C	7 oz, 9"	EACH	7.14	12	24	1.32

WINE GLASSES

ITEM	DESCRIPTION	U/M	WEIGHT GROSS lbs	INNER PACK	MASTER PACK	CU. FT.
PLTHWG011RC	11 oz, 9"	EACH	7.25	12	24	1.42
PLTHWG014RC	14 oz, 9 3/4"	EACH	8.91	12	24	1.83
PLTHWG023RC	23 oz, 9"	EACH	7.94	12	24	2.27
PLTHWG025RC	25 oz, 8 5/8"	EACH	8.38	12	24	2.56



PLTHSS016C

SHOT SHAKER

ITEM	DESCRIPTION	U/M	WEIGHT GROSS lbs	INNER PACK	MASTER PACK	CU. FT.
PLTHSS016C	16 oz - 3 Piece Set, 8¾"	EACH	16.90	6	36	2.23



PLTHCF050CC

PLTHCF100CC

CARAFE

ITEM	DESCRIPTION	U/M	WEIGHT GROSS lbs	INNER PACK	MASTER PACK	CU. FT.
PLTHCF050CC	17 oz Carafe - ½ liter, 6"	EACH	3.55	12	12	0.60
PLTHCF100CC	34 oz Carafe - 1 liter, 9¾"	EACH	5.71	12	12	1.02
PLTHSL001W	Snap Lid (White Polypropylene)	EACH	6.59	12	144	0.62



PLTHWD009C

PLTHCF075NC

DECANTER

ITEM	DESCRIPTION	U/M	WEIGHT GROSS lbs	INNER PACK	MASTER PACK	CU. FT.
PLTHWD009C	9 oz, 9¾"	EACH	4.19	12	24	0.71
PLTHCF075NC	750 ml, 9¾"	EACH	6.00	12	12	1.34



PLTHSN024C

SCHOONER

ITEM	DESCRIPTION	U/M	WEIGHT GROSS lbs	INNER PACK	MASTER PACK	CU. FT.
PLTHSN024C	24 oz Schooner, 7¼"	EACH	11.97	12	12	1.10



BAR SUPPLIES

2024

TABLE MOUNT WINE OPENER

This durable mirror polished stainless steel wine opener uses a lever-action mechanism to insert the corkscrew smoothly into the bottle and removes the cork with one quick, upward motion.

ITEM	DESCRIPTION	U/M	WEIGHT GROSS lbs	INNER PACK	MASTER PACK	CU. FT.
SLDWO001	11¾" x 11" x 2" Clamp on max - 1.5" Thick table	EACH	17.64	1	6	1.43



SLDWO001

BOTTLE AND CAN OPENER

Convenient compact size, for professional bartending. A multi-purpose tool for opening medium size cans and bottle caps.

ITEM	DESCRIPTION	U/M	WEIGHT GROSS lbs	INNER PACK	MASTER PACK	CU. FT.
SLBO002	Flat - 7" x 2"	EACH	49.50	24	240	0.22
SLBO003	Can Opener - 4¼" x ¾" x 1"	EACH	28.66	60	600	0.36
SLBO004	Wall Mount Bottle Opener - 4½" x 2½" x 1"	EACH	49.50	24	288	0.47
SLBO005	Corkscrew Opener, Chrome Plated - 6½" x 2½" x 2½"	EACH	46.30	12	144	3.01
WDW06768	Corkscrew w/ Wooden Handle - 4" x 4" x 1½"	EACH	5.95	24	120	0.64
OW115	Champagne Opener - 7" x 2¾" x 1¾"	EACH	52.80	12	144	1.84
OW110	Rotary Can Opener 8" x 2" x 2½"	EACH	44.53	12	96	1.72
SLBO106	Punch Can Opener 7" x 1¾" x 1"	EACH	38.14	12	144	0.23

SLBO002

SLBO004

SLBO003

SLBO106



SLBO005



WDW06768



OW115



OW110



CAP CATCHER

Smooth back notch for flat wall-mounting. Deep inner catcher for containing bottle caps.



ITEM	DESCRIPTION	U/M	WEIGHT GROSS lbs	INNER PACK	MASTER PACK	CU. FT.
SLCCA13	5½" x 10"	EACH	43.56	12	24	3.61

SLCCA13



BAR SUPPLIES

219

MRWC001R



MRWC002R

MARBLE WINE COOLER

ITEM	DESCRIPTION	U/M	WEIGHT GROSS lbs	INNER PACK	MASTER PACK	CU. FT.
MRWC001R	4 1/2" x 6" Black	EACH	24.20	1	6	0.75
MRWC002R	4 1/2" x 6" Natural	EACH	24.20	1	6	0.75



PLBC004P

4 COMPARTMENT BAR CADDY WITH COVER

Sturdy and easy to clean.

ITEM	DESCRIPTION	U/M	WEIGHT GROSS lbs	INNER PACK	MASTER PACK	CU. FT.
PLBC004P	18" x 5" x 3"	EACH	43.25	6	36	5.78



SLCN004

CONDIMENT COMPARTMENT & REPLACEMENT INSERT

1-pint plastic inserts. Detachable. Acrylic lid hinged onto stainless steel casing. (Open bottom).

ITEM	DESCRIPTION	U/M	WEIGHT GROSS lbs	INNER PACK	MASTER PACK	CU. FT.
SLCN004	4 Compartments 12" x 5 7/8" x 3 1/2"	EACH	33.10	1	16	3.00
SLCN005	5 Compartments 15" x 5 7/8" x 3 1/2"	EACH	41.50	1	16	3.70
SLCN006	6 Compartments 17 7/8" x 5 7/8" x 3 1/2"	EACH	44.09	1	16	4.50



SLINS002

SLINS001

Condiment Replacement Inserts, 2 Sizes

SLINS001	Large, 2 Pint 6" x 5 7/8" x 3"	EACH	14.90	12	60	2.55
SLINS002	Small, 1 Pint 5 3/4" x 3" x 3"	EACH	18.85	12	120	2.41



SSCD004

CONDIMENT COMPARTMENT

(Open bottom)



ITEM	DESCRIPTION	U/M	WEIGHT GROSS lbs	INNER PACK	MASTER PACK	CU. FT.
SSCD003	3 Compartments	EACH	37.48	1	16	2.72
SSCD004	4 Compartments	EACH	39.60	1	16	3.56
SSCD005	5 Compartments	EACH	50.60	1	16	4.24
SSCD006	6 Compartments	EACH	57.20	1	16	5.03

SPEED RAIL

Organize and store bar pour bottles or other bottles for fast and easy access.



SLSPR022S



ITEM	DESCRIPTION	U/M	WEIGHT GROSS lbs	INNER PACK	MASTER PACK	CU. FT.
SLSPR022S	22" x 4" x 6 1/8"	EACH	28.66	1	8	3.35
SLSPR032S	32" x 4" x 6 1/8"	EACH	30.86	1	6	3.66
SLSPR042S	42" x 4" x 6 1/8"	EACH	24.25	1	4	3.20

SLSPR032S



SLSPR042S

MUDDLER

Bar muddler with tenderizer head is just the right tool for mashing up fruits, herbs and spices to make those mixed drinks pop. The tenderizer head offers a comprehensive mash.

ITEM	DESCRIPTION	U/M	WEIGHT GROSS lbs	INNER PACK	MASTER PACK	CU. FT.
WDML008W	8" x 1" x 1", Flat Head, Walnut	EACH	23.15	24	144	1.25
PLML008N	8" x 1" x 1", Netted Head, Black	EACH	57.38	12	216	1.75
PLML008T	8" x 1" x 1", Triangular Head, Black	EACH	59.76	12	216	1.83



WDML008W
Lacquered
Wood



PLML008N
Polycarbonate



PLML008T
Polycarbonate

DELUXE BAR SPOON

The handle is twirled for easy stirring.



ITEM	DESCRIPTION	U/M	WEIGHT GROSS	INNER PACK	MASTER PACK	CU. FT.
SLKBS011	11" Length	EACH	20.28	24	240	0.49



SLKBS011

BAR TONG

Hang tag packaging.



ITEM	DESCRIPTION	U/M	WEIGHT GROSS lbs	INNER PACK	MASTER PACK	CU. FT.
IRSH4403	4 3/4" Multi-Functional Tongs	EACH	24.26	12	360	1.80
SLGB026	9 7/8" Bean Tongs	EACH	40.13	12	360	3.00
SLPB030	12" Plum Tongs	EACH	40.13	12	360	3.48



IRSH4403

SLGB026

SLPB030

STRAINER



ITEM	DESCRIPTION	U/M	WEIGHT GROSS lbs	INNER PACK	MASTER PACK	CU. FT.
SLBS022	Bar Strainer 6" x 4 5/8" x 7/8"	EACH	14.33	24	120	1.22
SLJS031	Julep Strainer 6 1/8" x 2 7/8" x 1 1/2"	EACH	23.75	12	240	0.76



SLBS022



SLJS031



SLHO030

SCOOP



ITEM	DESCRIPTION	U/M	WEIGHT GROSS lbs	INNER PACK	MASTER PACK	CU. FT.
SLHO030	4 oz - 9 3/4" x 3 5/8" x 1"	EACH	24.64	12	144	1.22



IRCP008

IRPC008

ICE CHIPPER & ICE PICK

Comes with comfortable wooden handle.

ITEM	DESCRIPTION	U/M	WEIGHT GROSS lbs	INNER PACK	MASTER PACK	CU. FT.
IRCP008	9" Chipper - 9" x 2 7/16" x 9/2"	EACH	40.79	12	120	1.32
IRPC008	8" Pick - 8" x 1 3/16" x 1 1/16"	EACH	30.36	12	180	3.81

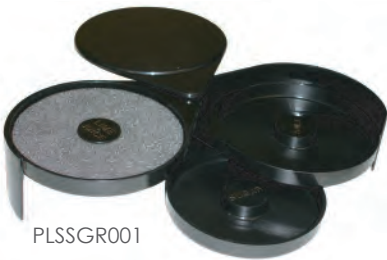

PLSSGR001

SALT & SUGAR GLASS RIMMER

Folds to small package for easy storage. Accommodates cocktail glasses up to 5 1/2 in diameter.

ITEM	DESCRIPTION	U/M	WEIGHT GROSS lbs	INNER PACK	MASTER PACK	CU. FT.
PLSSGR001	Three swing trays with a sponge for dampening the glass rim	EACH	25.96	2	24	1.96



PLBC006

BAR CADDY



ITEM	DESCRIPTION	U/M	WEIGHT GROSS lbs	INNER PACK	MASTER PACK	CU. FT.
PLBC006	Plastic Bar Caddy 6 Compartments 9 1/2" x 5 3/4" x 4 1/8"	EACH	15.19	1	12	1.92



PLTP050A Arrow

PLTP050S Sword

PICKS

Assorted colors. (500 piece per pack)



ITEM	DESCRIPTION	U/M	WEIGHT GROSS	INNER PACK	MASTER PACK	CU. FT.
PLTP050A	3 1/2" Arrow	PACK	23.15	24	96	2.85
PLTP050S	3" Sword	PACK	35.27	12	96	6.11

COCKTAIL SHAKER

Versatile functions for both dry and wet products.



ITEM	DESCRIPTION	U/M	WEIGHT GROSS lbs	INNER PACK	MASTER PACK	CU. FT.
SLIG001	15 oz - 3 ⁵ / ₁₆ " x 3 ⁵ / ₁₆ " x 4 ⁵ / ₈ "	EACH	49.94	12	144	1.08
SLIG002	30 oz - 3 ⁵ / ₈ " x 3 ⁵ / ₈ " x 7"	EACH	36.00	6	72	1.37



SLIG001



SLIG002

COCKTAIL SHAKER SET

Mirror-finished stainless steel mixer. Three-piece ensemble: container, cup and ice strainer for spill-free pouring.



ITEM	DESCRIPTION	U/M	WEIGHT GROSS lbs	INNER PACK	MASTER PACK	CU. FT.
SLIG008	8 oz - 3 Piece Set 2 ³ / ₄ " x 2 ³ / ₄ " x 7 ¹ / ₈ "	EACH	19.84	1	48	2.40
SLIG003	16 oz - 3 Piece Set 3" x 3" x 7 ⁵ / ₈ "	EACH	14.40	1	24	1.42
SLIG004	28 oz - 3 Piece Set 3 ⁵ / ₈ " x 3 ⁵ / ₈ " x 10"	EACH	16.94	1	24	2.84



SLIG008

SLIG003

SLIG004

MALT CUP

Fits standard machines.



ITEM	DESCRIPTION	U/M	WEIGHT GROSS lbs	INNER PACK	MASTER PACK	CU. FT.
SLMC001	30 oz 4 ¹ / ₈ " x 4 ¹ / ₈ " x 6 ³ / ₄ "	EACH	34.87	6	72	1.49



SLMC001

JIGGER

Holds from 1/2 oz to 2 oz.



ITEM	DESCRIPTION	U/M	WEIGHT GROSS lbs	INNER PACK	MASTER PACK	CU. FT.
SLJG001	1/2 & 1 oz 2" x 2" x 2 ³ / ₁₆ "	EACH	24.25	12	300	1.96
SLJG002	3/4 & 1 1/2 oz 1 ⁷ / ₈ " x 2 ⁵ / ₁₆ " x 2 ¹ / ₁₆ "	EACH	31.80	12	300	3.53
SLJG003	1 & 2 oz 2 ⁵ / ₈ " x 2 ⁵ / ₈ " x 3 ¹ / ₈ "	EACH	37.70	12	300	4.68



SLJG001



SLJG002



SLJG003

INTERLOCKING MAT

ITEM	DESCRIPTION	U/M	WEIGHT GROSS lbs	INNER PACK	MASTER PACK	CU. FT.
PLIM1212SM	12" x 12" Black	EACH	11.44	1	12	0.69

- Light weight
- Dishwasher safe
- Sanitary
- Durable
- Easy assembly

PLIM1212SM



Bar mat securely interlocks via underside tab. Mat can be easily put together and taken apart to fit desired area.

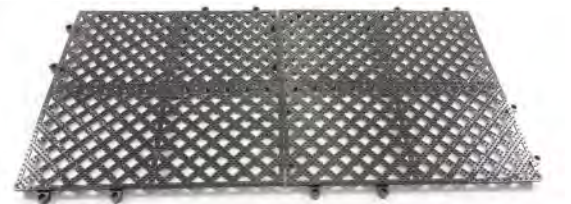
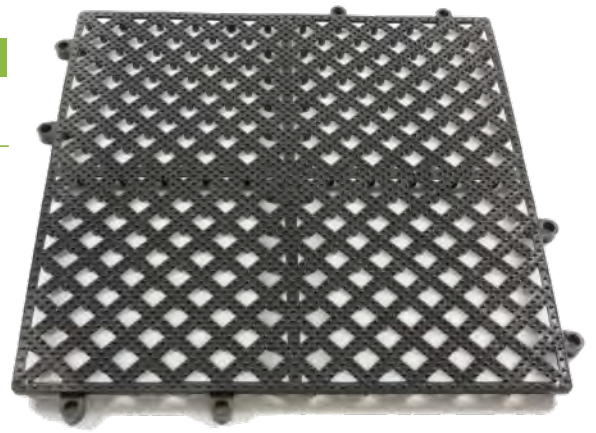

Two interlocked bar mats.

BAR SERVICE MAT

The non-slip drainer/mats are essential to keep counter tops clean. Pattern molds helps to secure grip for wet glassware, and the receptacle ends provides drainage for spilled drinks. Easy to wash. Available in brown or black.

ITEM	DESCRIPTION	U/M	WEIGHT GROSS lbs	INNER PACK	MASTER PACK	CU. FT.
Service Mat						
PLSVM1218BL	12" x 18" Black	EACH	26.23	1	12	0.71
PLSVM1218R	12" x 18" Brown	EACH	26.23	1	12	0.71
Bar Mat						
PLBM027BL	27" x 3 1/4" Black	EACH	48.50	1	50	1.98
PLBM027R	27" x 3 1/4" Brown	EACH	48.50	1	50	1.98

SERVICE MAT

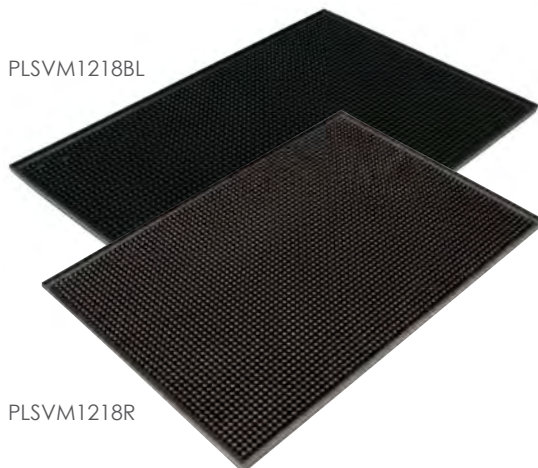

PLSVM1218BL

PLSVM1218R

BAR MAT

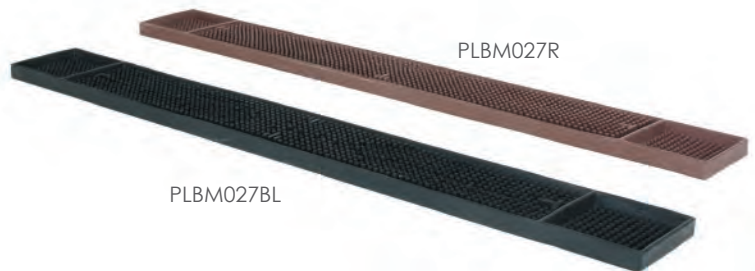

PLBM027R

PLBM027BL

BAR LINER

Bar liners provide impact absorption and drainage.

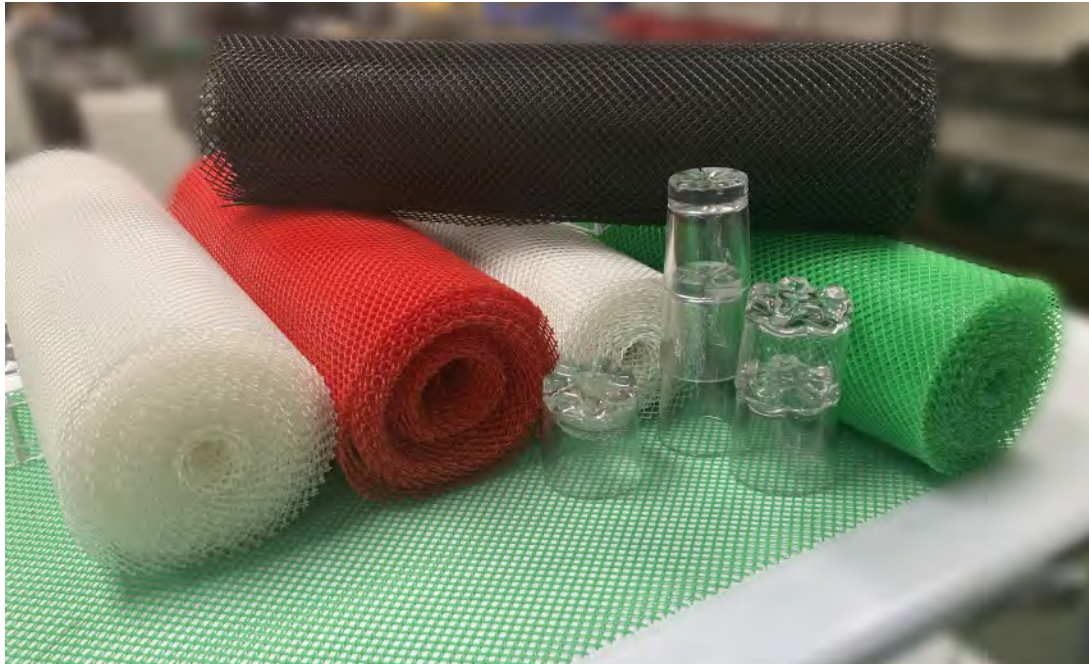

ITEM	DESCRIPTION	U/M	WEIGHT GROSS lbs	INNER PACK	MASTER PACK	CU. FT.
PLBL240C	2' x 40' Clear	EACH	13.23	1	2	2.02
PLBL240G	2' x 40' Green	EACH	13.23	1	2	2.02
PLBL240K	2' x 40' Black	EACH	13.23	1	2	2.02
PLBL240R	2' x 40' Red	EACH	13.23	1	2	2.02
PLBL240W	2' x 40' White	EACH	13.23	1	2	2.02

WIRE GLASS HANGER

Stores glass stemware.

ITEM	DESCRIPTION	U/M	WEIGHT GROSS lbs	INNER PACK	MASTER PACK	CU. FT.
Brass Plated						
SLKGH010	10" x 4 ⁹ / ₁₆ " x 1 ⁵ / ₈ "	EACH	41.01	12	120	2.54
SLKGH016	16" x 4 ⁹ / ₁₆ " x 1 ⁵ / ₈ "	EACH	28.00	12	60	2.09
SLKGH024	24" x 4 ⁹ / ₁₆ " x 1 ⁵ / ₈ "	EACH	37.04	12	60	3.11
Chrome Plated						
SLKGH010C	10" x 4 ⁹ / ₁₆ " x 1 ⁵ / ₈ "	EACH	41.01	12	120	2.54
SLKGH016C	16" x 4 ⁹ / ₁₆ " x 1 ⁵ / ₈ "	EACH	28.00	12	60	2.09
SLKGH024C	24" x 4 ⁹ / ₁₆ " x 1 ⁵ / ₈ "	EACH	37.04	12	60	3.11

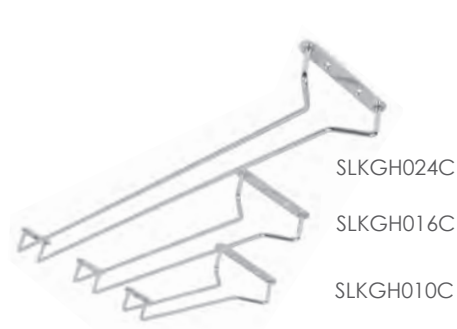

LIQUOR & JUICE POUR BOTTLES



PLSNP01B



PLSNP01G



PLSNP01O



PLSNP01R



PLSNP01W



PLSNP01Y

1 QT

Color Coded

ITEM	DESCRIPTION	U/M	WEIGHT GROSS lbs	INNER PACK	MASTER PACK	CU. FT.
PLSNP01B	1 qt Brown - 3¾" x 3¾" x 13½"	EACH	5.84	1	12	0.85
PLSNP01G	1 qt Green - 3¾" x 3¾" x 13½"	EACH	5.84	1	12	0.85
PLSNP01O	1 qt Orange - 3¾" x 3¾" x 13½"	EACH	5.84	1	12	0.85
PLSNP01R	1 qt Red - 3¾" x 3¾" x 13½"	EACH	5.84	1	12	0.85
PLSNP01W	1 qt White - 3¾" x 3¾" x 13½"	EACH	5.84	1	12	0.85
PLSNP01Y	1 qt Yellow - 3¾" x 3¾" x 13½"	EACH	5.84	1	12	0.85



PLSNP02B



PLSNP02G



PLSNP02O



PLSNP02R



PLSNP02W



PLSNP02Y

2 QT

Color Coded

ITEM	DESCRIPTION	U/M	WEIGHT GROSS lbs	INNER PACK	MASTER PACK	CU. FT.
PLSNP02B	2 qt Brown - 4½" x 4½" x 13¾"	EACH	3.28	1	6	0.87
PLSNP02G	2 qt Green - 4½" x 4½" x 13¾"	EACH	3.28	1	6	0.87
PLSNP02O	2 qt Orange - 4½" x 4½" x 13¾"	EACH	3.28	1	6	0.87
PLSNP02R	2 qt Red - 4½" x 4½" x 13¾"	EACH	3.28	1	6	0.87
PLSNP02W	2 qt White - 4½" x 4½" x 13¾"	EACH	3.28	1	6	0.87
PLSNP02Y	2 qt Yellow - 4½" x 4½" x 13¾"	EACH	3.28	1	6	0.87



POURER

Economy free flow pourer with wide range of selection on flow speeds.



ITEM	DESCRIPTION	U/M	WEIGHT GROSS lbs	INNER PACK	MASTER PACK	CU. FT.
Stainless Steel						
PLPR501S	Tapered, Med Flow - 4½" x 1½" x 1½"	PACK OF 12	17.60	12	48	2.88
PLPR505S	Tapered with Flip Cap, Med Flow - 4½" x 1½" x 1½"	PACK OF 12	23.54	12	48	2.88
PLPR503S	Jet, Extra Fast Flow - 4½" x 1½" x 1½"	PACK OF 12	17.97	12	48	2.88
PLPR502S	Jet with Flip Cap, Fast Flow - 4½" x 1½" x 1½"	PACK OF 12	19.49	12	48	2.88
PLPR504S	Gooseneck, Fast Flow - 4½" x 1½" x 1½"	PACK OF 12	18.35	12	48	2.88
Chrome						
PLPR506S	Free Flow. Soft Collar	PACK OF 12	23.23	12	72	2.24
PLPR507S	Free Flow. No Collar	PACK OF 12	18.68	12	72	2.24

POURER COVER



UNIVERSAL CAP

PLPRC001

DUST CAP



PLPRC002BK



PLPRC002RD

ITEM	DESCRIPTION	U/M	WEIGHT GROSS lbs	INNER PACK	MASTER PACK	CU. FT.
PLPRC001	Universal Cap, Plastic - 3" x 1½" x 1½"	PACK OF 12	25.45	12	48	2.88
PLPRC002BK	Dust Cap, 1", Black, Plastic - ½" x ½" x ⅝"	PACK OF 12	10.12	1	144	0.98
PLPRC002RD	Dust Cap, 1", Red, Plastic	PACK OF 12	10.12	1	144	0.98

MEASURED POURER

Fits standard 750 mL liquor bottles and color coded for portion control.

Collared



PLPR050C

PLPR063C

PLPR075C

PLPR088C

PLPR100C

PLPR113C

PLPR125C

PLPR150C

PLPR200C

Color Coded

ITEM	DESCRIPTION	U/M	WEIGHT GROSS lbs	INNER PACK	MASTER PACK	CU. FT.
PLPR050C	½ oz, Orange Tail	PACK OF 12	16.02	1	25	1.19
PLPR063C	⅝ oz, Black Tail	PACK OF 12	16.02	1	25	1.19
PLPR075C	¾ oz, Green Tail	PACK OF 12	16.02	1	25	1.19
PLPR088C	⅞ oz, Blue Tail	PACK OF 12	16.02	1	25	1.19
PLPR100C	1 oz, Red Tail	PACK OF 12	16.02	1	25	1.19
PLPR113C	1 ⅙ oz, Purple Tail	PACK OF 12	16.02	1	25	1.19
PLPR125C	1 ¼ oz, Clear Tail	PACK OF 12	16.02	1	25	1.19
PLPR150C	1 ½ oz, Yellow Tail	PACK OF 12	16.02	1	25	1.19
PLPR200C	2 oz, White Tail	PACK OF 12	16.02	1	25	1.19

Package of 12



Without Collar



PLPR050M

PLPR063M

PLPR075M

PLPR088M

PLPR100M

PLPR113M

PLPR125M

PLPR150M

PLPR200M

Color Coded

ITEM	DESCRIPTION	U/M	WEIGHT GROSS lbs	INNER PACK	MASTER PACK	CU. FT.
PLPR050M	½ oz, Orange Tail	PACK OF 12	12.72	1	25	1.19
PLPR063M	⅝ oz, Black Tail	PACK OF 12	12.72	1	25	1.19
PLPR075M	¾ oz, Green Tail	PACK OF 12	12.72	1	25	1.19
PLPR088M	⅞ oz, Blue Tail	PACK OF 12	12.72	1	25	1.19
PLPR100M	1 oz, Red Tail	PACK OF 12	12.72	1	25	1.19
PLPR113M	1 ⅙ oz, Purple Tail	PACK OF 12	12.72	1	25	1.19
PLPR125M	1 ¼ oz, Clear Tail	PACK OF 12	12.72	1	25	1.19
PLPR150M	1 ½ oz, Yellow Tail	PACK OF 12	12.72	1	25	1.19
PLPR200M	2 oz, White Tail	PACK OF 12	12.72	1	25	1.19

Package of 12



SCREENED POURER

The build-in screen will keep bugs and insects from entering the bottle.



Color Coded

ITEM	DESCRIPTION	U/M	WEIGHT GROSS lbs	INNER PACK	MASTER PACK	CU. FT.
PLPR600AM	Amber - 3½" x 1⅝" x 1⅝"	PACK OF 12	15.44	12	48	2.88
PLPR600CL	Clear - 3½" x 1⅝" x 1⅝"	PACK OF 12	15.44	12	48	2.88
PLPR600RD	Red - 3½" x 1⅝" x 1⅝"	PACK OF 12	15.44	12	48	2.88
PLPR600SM	Smoke - 3½" x 1⅝" x 1⅝"	PACK OF 12	15.44	12	48	2.88

FLOW LIQUOR POURER

Collared



With Collar

Without Collar

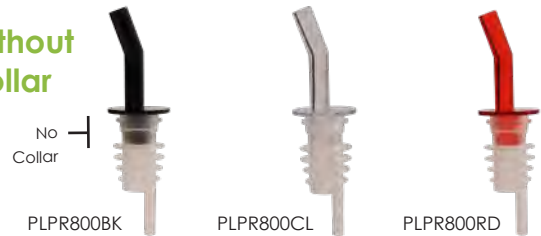

No Collar

ITEM	DESCRIPTION	U/M	WEIGHT GROSS lbs	INNER PACK	MASTER PACK	CU. FT.
PLPR700BK	Black - 4½" x 1½" x 1½"	PACK OF 12	18.37	12	48	2.88
PLPR700CL	Clear - 4½" x 1½" x 1½"	PACK OF 12	18.37	12	48	2.88
PLPR700RD	Red - 4½" x 1½" x 1½"	PACK OF 12	18.37	12	48	2.88
PLPR800BK	Black - 3½" x 1½" x 1½"	PACK OF 12	12.28	12	48	2.88
PLPR800CL	Clear - 3½" x 1½" x 1½"	PACK OF 12	12.28	12	48	2.88
PLPR800RD	Red - 3½" x 1½" x 1½"	PACK OF 12	12.28	12	48	2.88

FREE FLOW POURER



Color Coded

ITEM	DESCRIPTION	U/M	WEIGHT GROSS lbs	INNER PACK	MASTER PACK	CU. FT.
PLPR900BK	Black - 2⅔" x 1⅝" x 1⅝"	PACK OF 12	13.90	12	72	2.24
PLPR900BL	Blue - 2⅔" x 1⅝" x 1⅝"	PACK OF 12	13.90	12	72	2.24
PLPR900CL	Clear - 2⅔" x 1⅝" x 1⅝"	PACK OF 12	13.90	12	72	2.24
PLPR900GR	Green - 2⅔" x 1⅝" x 1⅝"	PACK OF 12	13.90	12	72	2.24
PLPR900RD	Red - 2⅔" x 1⅝" x 1⅝"	PACK OF 12	13.90	12	72	2.24
PLPR900WH	White - 2⅔" x 1⅝" x 1⅝"	PACK OF 12	13.90	12	72	2.24
PLPR900YW	Yellow - 2⅔" x 1⅝" x 1⅝"	PACK OF 12	13.90	12	72	2.24

SLIP RESISTANT SERVING TRAY

Anti-slip serving trays with textured surface or cork.

ABS

	ITEM	DESCRIPTION	U/M	WEIGHT GROSS lbs	INNER PACK	MASTER PACK	CU. FT.
Textured Surface	PLRT012	12" Round, (S), Black	EACH	42.99	12	60	1.95
	PLRT014	14" Round, (M), Black	EACH	55.12	12	48	2.00
	PLRT016	16" Round, (L), Black	EACH	70.55	12	48	2.55
	PLRT1612	16" x 12 Rectangular, Black	EACH	42.99	12	36	2.42
Cork	PLRT012BCK	12" Round w/ Cork, (S), Black	EACH	45.10	12	60	1.95
	PLRT014BCK	14" Round w/ Cork, (M), Black	EACH	48.38	12	48	2.00
	PLRT016BCK	16" Round w/ Cork, (L), Black	EACH	61.71	12	48	2.55
	PLRT1612BCK	16" x 12 Rectangular w/ Cork, Black	EACH	44.35	12	36	2.42
	PLRT012CK	12" Round w/ Cork, (S), Brown	EACH	45.19	12	60	1.95
	PLRT014CK	14" Round w/ Cork, (M), Brown	EACH	48.48	12	48	2.00
	PLRT016CK	16" Round w/ Cork, (L), Brown	EACH	61.84	12	48	2.55
	PLRT1612CK	16" x 12" Rectangular w/ Cork, Brown	EACH	44.44	12	36	2.42



POLYPROPYLENE

	ITEM	DESCRIPTION	U/M	WEIGHT GROSS lbs	INNER PACK	MASTER PACK	CU. FT.
Black	PLST1100BL	11" Round Tray	EACH	10.36	12	12	0.31
	PLST1400BL	14" Round Tray	EACH	14.11	12	12	0.49
	PLST1600BL	16" Round Tray	EACH	25.35	12	12	0.72
	PLST1418BL	14" x 18" Rectangular Tray	EACH	22.48	12	12	0.75
	PLST2700BL	22" x 27" Oval Tray	EACH	35.26	6	6	1.89
Brown	PLST1100BR	11" Round Tray	EACH	10.36	12	12	0.31
	PLST1400BR	14" Round Tray	EACH	14.11	12	12	0.49
	PLST1600BR	16" Round Tray	EACH	25.35	12	12	0.72
	PLST1418BR	14" x 18" Rectangular Tray	EACH	22.48	12	12	0.75
	PLST2700BR	22" x 27" Oval Tray	EACH	35.26	6	6	1.89

Round Tray
PLST1100 ~ PLST1600



PLST1418



PLST2700



FIBERGLASS

	ITEM	DESCRIPTION	U/M	WEIGHT GROSS lbs	INNER PACK	MASTER PACK	CU. FT.
Black	PLFT1100BK	11" Round	EACH	10.14	1	12	0.34
	PLFT1400BK	14" Round	EACH	16.09	1	12	0.52
	PLFT1418BK	14" x 18" Rectangular	EACH	28.66	1	12	0.77
	PLFT1600BK	16" Round	EACH	25.35	1	12	0.72
	PLFT2700BK	22" x 27" Oval	EACH	27.78	1	6	1.91
Brown	PLFT1100BR	11" Round	EACH	10.14	1	12	0.34
	PLFT1400BR	14" Round	EACH	16.09	1	12	0.52
	PLFT1418BR	14" x 18" Rectangular	EACH	28.66	1	12	0.77
	PLFT1600BR	16" Round	EACH	25.35	1	12	0.72
	PLFT2700BR	22" x 27" Oval	EACH	27.78	1	6	1.91

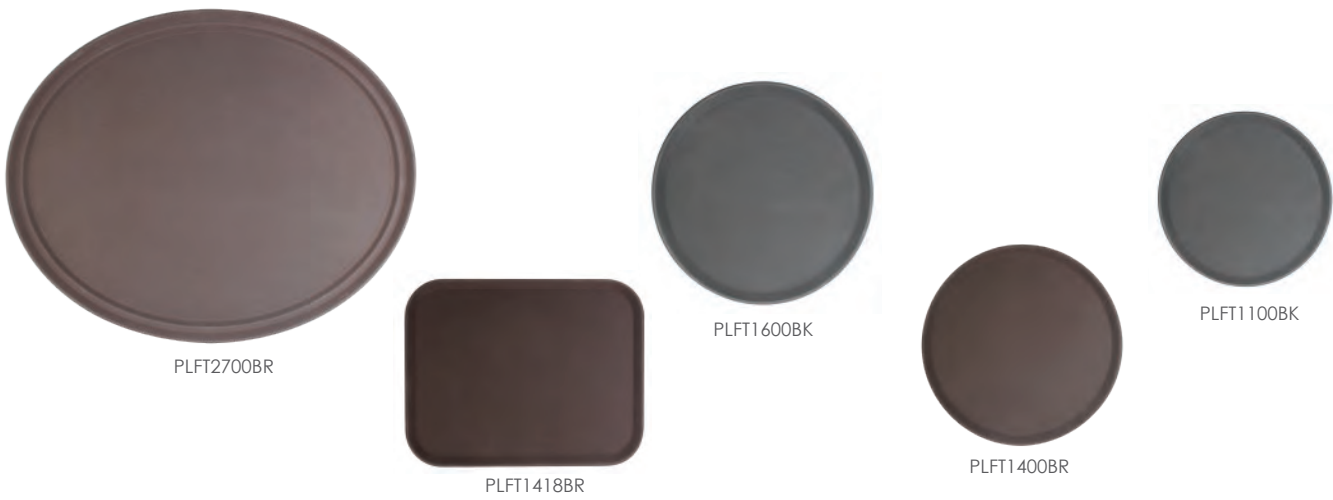

WINE BUCKET & FOLDABLE STAND

Present chilled wines and champagnes in an elegant ensemble.



ITEM	DESCRIPTION	U/M	WEIGHT GROSS lbs	INNER PACK	MASTER PACK	CU. FT.
SLWB001	8 qt Wine Bucket 10" x 9" x 10 1/8"	EACH	44.85	6	24	3.45
SLWB003	Foldable Stand 9 3/4" x 9 3/4" x 28 5/8"	EACH	36.30	3	12	1.23

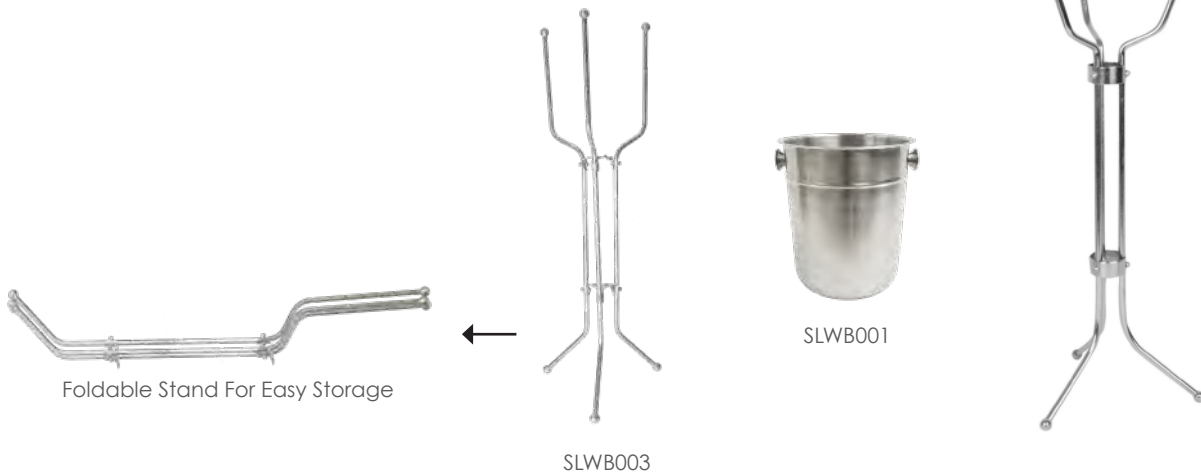

CATERING & BUFFETWARE



CATERING & BUFFETWARE



SLRCF0860

ROUND ROLL TOP CHAFER

Swivels open easily to 90 degree angle.



ITEM	DESCRIPTION	U/M	WEIGHT GROSS lbs	INNER PACK	MASTER PACK	CU. FT.
SLRCF0860	6 qt with Stainless Steel Handle 17" x 16½" x 17¾"	SET	24.25	1	1	3.28



SLRCF8632

DELUXE ROUND CHAFER

Stainless steel Deluxe Round Chafers with faux wood or brass handles and knobs with a polished finish cover. Serves up to 5 quarts.



ITEM	DESCRIPTION	U/M	WEIGHT GROSS lbs	INNER PACK	MASTER PACK	CU. FT.
SLRCF8632	5 qt with Wood Handle 17¾" x 13" x 16½"	SET	9.50	1	1	2.36
SLRCF8633	5 qt with Brass Handle 17¾" x 13" x 16½"	SET	10.50	1	1	2.36



SLRCF8633



SLRCF8633



SLRCF8307

MARMITE CHAFER



ITEM	DESCRIPTION	U/M	WEIGHT GROSS lbs	INNER PACK	MASTER PACK	CU. FT.
SLRCF8307	7 qt 12½" x 9¼" x 13¼"	EACH	6.83	1	1	0.81
SLRCF8311	11 qt 14½" x 11½" x 13¼"	EACH	7.94	1	1	1.08



SLRCF8311



SLRCF8307

DELUXE CHAFER - HALF SIZE



ITEM	DESCRIPTION	U/M	WEIGHT GROSS lbs	INNER PACK	MASTER PACK	CU. FT.
SLRCF0825	4 qt with Faux Wood Handle 17 ¹ / ₁₆ " x 11 ¹ / ₁₆ " x 16 ³ / ₁₆ "	SET	9.76	1	1	1.42



SLRCF0825

DELUXE CHAFER - FULL SIZE

Full size Deluxe Chafers. Handles also available in faux wood or brass.



ITEM	DESCRIPTION	U/M	WEIGHT GROSS lbs	INNER PACK	MASTER PACK	CU. FT.
SLRCF8532	8 qt with Faux Wood Handle 26 ¹ / ₂ " x 14" x 16 ¹ / ₂ "	SET	17.00	1	1	2.84
SLRCF8533	8 qt with Brass Handle 26 ¹ / ₂ " x 14" x 16 ¹ / ₂ "	SET	16.42	1	1	2.84



SLRCF8532



SLRCF8533



SLRCF8532

CONTINENTAL CHAFER



ITEM	DESCRIPTION	U/M	WEIGHT GROSS lbs	INNER PACK	MASTER PACK	CU. FT.
SLRCF0840	8 qt with Brass Handle 22 ³ / ₈ " x 14 ⁷ / ₈ " x 12 ³ / ₄ "	SET	13.23	1	1	2.03



SLRCF0840

WIRE STAND

ITEM	DESCRIPTION	U/M	WEIGHT GROSS lbs	INNER PACK	MASTER PACK	CU. FT.
SLRCF511	22 ³ / ₄ " x 12 ¹ / ₄ " x 9" Wire Stand for Full Size Aluminum Foil Tray	EACH	17.64	1	10	3.42



SLRCF511

GOLD ACCENTED ROUND CHAFER



ITEM	DESCRIPTION	U/M	WEIGHT GROSS lbs	INNER PACK	MASTER PACK	CU. FT.
SLRCF0831GH	4 qt - 16½" x 13¾" x 12"	SET	8.50	1	1	1.14



SLRCF0831GH



Gift boxed

GOLD ACCENTED OVAL CHAFER



ITEM	DESCRIPTION	U/M	WEIGHT GROSS lbs	INNER PACK	MASTER PACK	CU. FT.
SLRCF0836GH	6 qt - 21¾" x 12¾" x 11½"	SET	10.58	1	1	1.93



SLRCF0836GH



Gift boxed

GOLD ACCENTED OBLONG CHAFER



ITEM	DESCRIPTION	U/M	WEIGHT GROSS lbs	INNER PACK	MASTER PACK	CU. FT.
SLRCF0833GH	8 qt - 25" x 13¾" x 12¼"	SET	13.23	1	1	2.07



SLRCF0833GH



Gift boxed

GOLD ACCENTED CHAFER



ITEM	DESCRIPTION	U/M	WEIGHT GROSS lbs	INNER PACK	MASTER PACK	CU. FT.
SLRCF0834GH	4 qt - 17" x 11½" x 12½"	SET	8.38	1	1	1.25



Gift boxed



SLRCF0834GH

STACKABLE CHAFER



ITEM	DESCRIPTION	U/M	WEIGHT GROSS lbs	INNER PACK	MASTER PACK	CU. FT.
SLRCF0833BT	8 qt - 24¾" x 14¾" x 12¾"	SET	13.67	1	1	2.07



Gift boxed



SLRCF0833BT

ROLL TOP CHAFER

Roll top golden chafers with gold accents on handles. Fuel holders side in underneath. 8 quart capacity.



ITEM	DESCRIPTION	U/M	WEIGHT GROSS lbs	INNER PACK	MASTER PACK	CU. FT.
SLRCF0171G	8 qt, with Golden Accent Handles 24¼" x 14¾" x 15½"	SET	24.47	1	1	3.27



Gift boxed



SLRCF0171G

ECONOMY CHAFER

Parts & accessories sold separately.



ITEM	DESCRIPTION	U/M	WEIGHT GROSS lbs	INNER PACK	MASTER PACK	CU. FT.
SLRCF001F	8 qt - 23 $\frac{3}{8}$ " x 13 $\frac{1}{8}$ " x 12 $\frac{3}{8}$ ", w/ Folding Stand	SET	11.01	1	1	1.15
SLRCF001	8 qt - 23 $\frac{3}{8}$ " x 13 $\frac{1}{8}$ " x 15 $\frac{1}{2}$ ", w/ Plastic Handle on Top Cover	SET	12.79	1	1	2.13
SLRCF002	8 qt - 23 $\frac{3}{8}$ " x 13 $\frac{1}{8}$ " x 13 $\frac{3}{8}$ " Plastic Footed	SET	13.23	1	1	2.17
SLRCF005	8 qt - 22 $\frac{1}{2}$ " x 14 $\frac{1}{8}$ " x 12 $\frac{3}{4}$ " Foldable	SET	13.67	1	1	1.29



SLRCF001F



Foldable Stand



Gift Boxed



SLRCF001



Gift boxed



SLRCF002



Gift boxed



Holder clips for cover included



SLRCF005



Gift boxed

CHAFFER PARTS & ACCESSORIES

ITEM	DESCRIPTION	U/M	WEIGHT GROSS lbs	INNER PACK	MASTER PACK	CU. FT.
SLRCF100	Cover Holder Clip 5 ⁹ / ₈ " x 1" x 1"	EACH	3.09	12	12	0.70
SLRCF111	Dripless Water Pan 22" x 14" x 4 ¹ / ₂ "	EACH	40.78	1	12	2.52
SLRCF112	Dome Cover with Plastic Handle 21 ¹ / ₈ " x 13 ³ / ₈ " x 4"	EACH	26.23	1	12	3.18
SLRCF113	Fuel Holder 6 ³ / ₈ " x 3 ¹ / ₂ " x 2 ⁵ / ₈ "	EACH	28.00	6	72	2.30
SLRCF114	Folding Frame with Fuel Plate 23" x 12 ¹ / ₂ " x 9"	SET	5.51	1	1	1.06
SLRCF115	Dome Cover With Chrome Plated Handle 21 ¹ / ₈ " x 13" x 3 ¹ / ₂ "	EACH	26.23	12	24	3.01



SLRCF112



SLRCF115



SLRCF100



SLRCF111



SLRCF114



SLRCF113



SLRCF114
Shown folded

HINGED DOME COVER

Hinged dome cover with handle, suitable for full size (8 qt) chafers.

ITEM	DESCRIPTION	U/M	WEIGHT GROSS lbs	INNER PACK	MASTER PACK	CU. FT.
SLRCF7100	Stainless Steel 21 ³ / ₈ " x 12" x 2 ¹ / ₂ "	EACH	41.89	3	12	5.00
PLRCF001H	Polycarbonate 21" x 13" x 3"	EACH	23.25	12	12	2.98
PLRCF001R	Roll Top Chafers Cover, Polycarbonate 21 ¹ / ₈ " x 14 ¹ / ₄ " x 7 ¹ / ₂ "	EACH	9.59	4	4	3.45



SLRCF7100



PLRCF001R



PLRCF001H



PLRCF001R

18/8 STAINLESS STEEL LUXOR SPOON

High quality serving spoons are elegantly crafted in 18/8 stainless steel in mirror finish.



ITEM	DESCRIPTION	U/M	WEIGHT GROSS lbs	INNER PACK	MASTER PACK	CU. FT.
Spoon						
SLBF101	13" Solid - 3 $\frac{3}{4}$ " x 2 $\frac{1}{2}$ " x 1 $\frac{5}{8}$ ", 9 $\frac{3}{4}$ " Handle Length	EACH	49.70	12	120	0.56
SLBF102	13" Slotted 3 $\frac{3}{4}$ " x 2 $\frac{1}{2}$ " x 1 $\frac{5}{8}$ ", 9 $\frac{3}{4}$ " Handle Length	EACH	45.40	12	120	0.56
SLBF103	10 $\frac{1}{2}$ " Solid 3 $\frac{3}{4}$ " x 2 $\frac{1}{2}$ " x 1 $\frac{5}{8}$ ", 7 $\frac{1}{8}$ " Handle Length	EACH	41.00	12	120	0.62
SLBF105	9 $\frac{3}{4}$ " Solid 3 $\frac{3}{8}$ " x 2 $\frac{1}{2}$ " x 1 $\frac{3}{8}$ ", 6 $\frac{3}{4}$ " Handle Length	EACH	29.00	12	120	0.45
SLBF106	9 $\frac{3}{4}$ " Slotted 3 $\frac{3}{8}$ " x 2 $\frac{1}{2}$ " x 1 $\frac{3}{8}$ ", 6 $\frac{3}{4}$ " Handle Length	EACH	28.99	12	120	0.45
Pastry Server						
SLBF109	8 $\frac{1}{2}$ " Pastry Server 5 $\frac{3}{8}$ " x 2 x 1 $\frac{5}{8}$ ", 3 $\frac{3}{4}$ " Handle Length	EACH	29.50	12	120	0.53

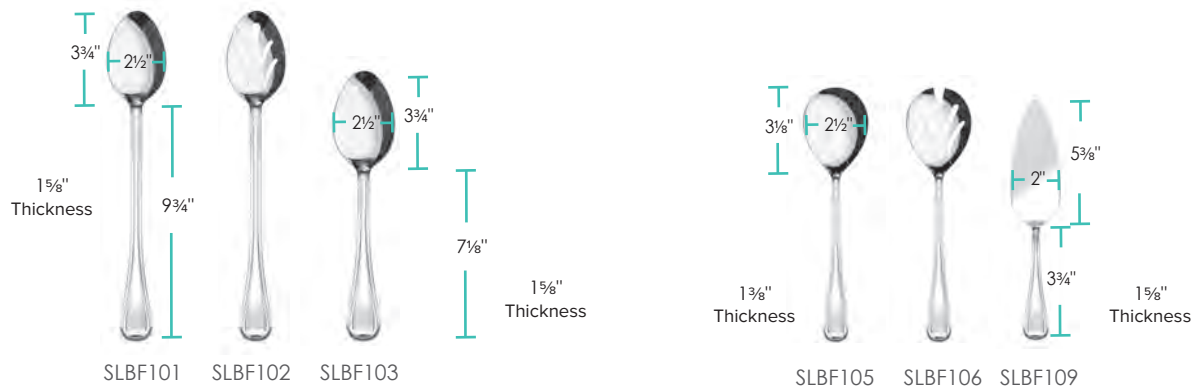

JUICE DISPENSER

ITEM	DESCRIPTION	U/M	WEIGHT GROSS lbs	INNER PACK	MASTER PACK	CU. FT.
SLRCF0031GH	2.2 Gallon, 10" x 13 $\frac{1}{16}$ " x 23 $\frac{1}{4}$ " - Gold Accented Knobs - Stainless Steel Lid & Base - Polycarbonate Body	EACH	12.79	1	1	2.23





BUFFETWARE

One-piece construction. Thick handles with finger grips fit the hand comfortably. A great contribution to buffet serving. Durable and easy to clean.



STAINLESS
STEEL

ITEM	DESCRIPTION	U/M	WEIGHT GROSS lbs	INNER PACK	MASTER PACK	CU. FT.
SLBF001	Solid Serving Spoon 12" x 2 ⁷ / ₁₆ " x 1"	EACH	38.58	12	144	1.14
SLBF002	Slotted Serving Spoon 11 ⁷ / ₈ " x 2 ⁷ / ₁₆ " x 1 ¹ / ₈ "	EACH	36.38	12	144	1.14
SLBF003	Notched Serving Spoon 11 ³ / ₄ " x 2 ⁷ / ₁₆ " x 1"	EACH	34.17	12	144	1.14
SLBF004	2-Tine Pot Fork 11 ¹ / ₈ " x 1" x 1 ¹ / ₄ "	EACH	29.76	12	144	0.96
SLBF005	4-Tine Meat Fork 10 ⁹ / ₁₆ " x 1 ³ / ₄ " x ⁷ / ₈ "	EACH	31.97	12	144	1.02
SLBF006	1 oz Spout Ladle 12" x 3 ¹ / ₄ " x 2"	EACH	49.60	12	144	1.36
SLBF007	2 oz Spout Ladle 12 ¹ / ₄ " x 3 ⁵ / ₈ " x 3 ¹ / ₄ "	EACH	55.12	12	144	1.84
SLBF008	4 oz Deep Ladle 12 ¹ / ₂ " x 3 ⁵ / ₈ " x 3 ¹ / ₄ "	EACH	61.73	12	144	2.32
SLBF009	Pastry Server 11 ¹ / ₈ " x 2 ³ / ₁₆ " x 1 ⁷ / ₁₆ "	EACH	47.40	12	144	1.28
SLBF010	Pie/Cake Server 11 ¹ / ₂ " x 4" x 2 ¹ / ₂ "	EACH	52.91	12	144	2.58
SLBF011	Perforated Turner 14 ¹ / ₄ " x 3 ¹ / ₄ " x 1 ¹ / ₈ "	EACH	55.12	12	144	1.40
SLBF012	Round Skimmer 14 ¹ / ₄ " x 4 ³ / ₁₆ " x 1 ³ / ₄ "	EACH	58.42	12	144	2.27
SLBF013	Carving Knife 12 ³ / ₄ " x ⁷ / ₈ " x ³ / ₈ "	EACH	33.07	12	144	1.09
SLBF014	Slicing Knife 13 ¹ / ₁₆ " x 1 ³ / ₁₆ " x ³ / ₈ "	EACH	35.27	12	144	1.16
SLBF015	Cheese Plane 11" x 2 ³ / ₁₆ " x 1 ⁵ / ₈ "	EACH	47.40	12	144	1.28



SLOP010 ~ SLOP026



OVAL PLATTER

Mirror finished.



ITEM	DESCRIPTION	U/M	WEIGHT GROSS lbs	INNER PACK	MASTER PACK	CU. FT.
SLOP010	10" x 7 ³ / ₁₆ " x ³ / ₄ "	EACH	29.29	12	72	0.77
SLOP012	12" x 8 ¹ / ₂ " x ⁷ / ₈ "	EACH	29.60	12	72	0.81
SLOP014	14" x 8 ³ / ₄ " x ¹ / ₂ "	EACH	24.44	12	36	0.62
SLOP016	16" x 10 ⁵ / ₈ " x 1"	EACH	35.16	12	36	0.85
SLOP018	18" x 11 ³ / ₄ " x 1 ¹ / ₄ "	EACH	43.25	12	24	1.10
SLOP020	20" x 13 ³ / ₈ " x 1 ¹ / ₈ "	EACH	48.49	12	24	1.33
SLOP022	22" x 14 ¹ / ₂ " x 1"	EACH	40.60	18	18	1.00
SLOP024	24" x 16 ³ / ₈ " x 1 ¹ / ₂ "	EACH	34.95	12	12	0.97
SLOP026	26" x 18" x 1 ³ / ₁₆ "	EACH	41.64	12	12	1.14



SLCT310 ~ SLCT318



ROUND TRAY with NARROW RIM

Edges contoured for tight secure grip.



ITEM	DESCRIPTION	U/M	WEIGHT GROSS lbs	INNER PACK	MASTER PACK	CU. FT.
SLCT310	10" Diameter	EACH	34.61	12	48	1.49
SLCT312	12" Diameter	EACH	46.85	12	48	2.08
SLCT314	14" Diameter	EACH	34.72	12	24	1.43
SLCT316	16" Diameter	EACH	50.15	12	24	1.83
SLCT318	18" Diameter	EACH	62.83	12	24	2.37



SLCS001

CAKE STAND



ITEM	DESCRIPTION	U/M	WEIGHT GROSS lbs	INNER PACK	MASTER PACK	CU. FT.
SLCS001	13 ¹ / ₄ " x 6"	EACH	34.00	1	12	5.08



PLATE COVER

Mirror finish. Nestles in place during stacked storage, or while in use.



STAINLESS STEEL

ITEM	DESCRIPTION	U/M	WEIGHT GROSS lbs	INNER PACK	MASTER PACK	CU. FT.
SLPC230	9 3/4" Diameter x 2 1/4" Height	EACH	33.00	12	48	1.37
SLPC250	10" Diameter x 2 3/8" Height	EACH	38.58	12	48	2.01



SLPC230
SLPC250

CONDIMENT PACK HOLDER



STAINLESS STEEL

ITEM	DESCRIPTION	U/M	WEIGHT GROSS lbs	INNER PACK	MASTER PACK	CU. FT.
SLFC002	Condiment Pack Holder with three divided areas. Fits 1/6 and 1/3 steam pans. 13 1/4" x 16 5/8" x 9"	EACH	29.98	1	4	5.63



SLFC002

*Steam pan shown - sold separately

FLATWARE CYLINDER HOLDER



STAINLESS STEEL

ITEM	DESCRIPTION	U/M	WEIGHT GROSS lbs	INNER PACK	MASTER PACK	CU. FT.
SLFC004	4 holes - 10 3/8" x 11 7/8" x 8"	EACH	24.25	1	6	4.26
SLFC006	6 holes - 15 1/4" x 11 7/8" x 8"	EACH	22.00	1	4	5.03



SLFC004



SLFC006

FLATWARE CYLINDER

Perforated holes for aeration. Outer lip fits perfectly in holders.

With Outer Lip
Straight Wall Style

ITEM	DESCRIPTION	U/M	WEIGHT GROSS lbs	INNER PACK	MASTER PACK	CU. FT.
PLFC001	Plastic with Outer Lip 4 3/8" Diameter x 5 3/8" Height	DOZEN	13.89	3	6	2.20
SLFC001	Stainless Steel with Outer Lip 4 3/8" Diameter x 5 3/8" Height	EACH	27.00	12	72	1.22
SLFC007	4 3/4" Diameter x 7" Height	EACH	21.78	12	48	5.61
SLFC008	4 1/2" Diameter x 5 1/2" Height	EACH	23.76	12	60	5.31



PLFC001



SLFC001



SLFC007



SLFC008

No outer lip



22 GAUGE ANTI-JAM STEAM PANS (EXTRA HEAVY)

ITEM	DESCRIPTION	U/M	WEIGHT GROSS lbs	INNER PACK	MASTER PACK	CU. FT.
STPA2001	Full Size 1 1/4" Deep	EACH	28.60	6	12	1.71
STPA2002	Full Size 2 1/2" Deep	EACH	37.05	6	12	2.74
STPA2004	Full Size 4" Deep	EACH	42.86	6	12	4.00
STPA2006	Full Size 6" Deep	EACH	50.12	6	12	4.63
STPA2121	Half Size 1 1/4" Deep	EACH	15.53	12	24	1.62
STPA2122	Half Size 2 1/2" Deep	EACH	39.95	12	24	1.96
STPA2124	Half Size 4" Deep	EACH	47.08	6	24	4.00
STPA2126	Half Size 6" Deep	EACH	53.68	6	12	2.47
STPA2132	Third Size 2 1/2" Deep	EACH	15.27	12	48	2.96
STPA2134	Third Size 4" Deep	EACH	67.14	12	24	2.21
STPA2136	Third Size 6" Deep	EACH	44.18	12	24	2.51
STPA2142	Quarter Size 2 1/2" Deep	EACH	23.32	12	72	3.47
STPA2144	Quarter Size 4" Deep	EACH	0.00	12	48	3.46
STPA2146	Quarter Size 6" Deep	EACH	73.48	12	24	1.92
STPA2162	Sixth Size 2 1/2" Deep	EACH	16.98	12	72	2.50
STPA2164	Sixth Size 4" Deep	EACH	60.02	12	48	2.42
STPA2166	Sixth Size 6" Deep	EACH	51.30	12	48	2.68
STPA2192	Ninth Size 2 1/2" Deep	EACH	22.26	12	72	1.84
STPA2194	Ninth Size 4" Deep	EACH	44.97	12	72	2.73
STPA2122L	Half Size Long 2" Deep	EACH	41.90	12	24	2.36
STPA2124L	Half Size Long 4" Deep	EACH	53.00	12	24	2.61
STPA2126L	Half Size Long 6" Deep	EACH	35.51	6	12	2.13
STPA2232	Two-Thirds Size 2 1/2" Deep	EACH	52.23	12	24	2.88
STPA2234	Two-Thirds Size 4" Deep	EACH	61.90	12	24	3.61
STPA2236	Two-Thirds Size 6" Deep	EACH	38.50	6	12	2.83

18/8 **SS** STAINLESS STEEL **NSF**

22 TRUE GAUGE



STPA2144

NEW

24 GAUGE ANTI-JAM STEAM PANS (HEAVY DUTY)

ITEM	DESCRIPTION	U/M	WEIGHT GROSS lbs	INNER PACK	MASTER PACK	CU. FT.
STPA3001	Full Size 1 1/4" Deep	EACH	22.97	6	12	2.67
STPA3002	Full Size 2 1/2" Deep	EACH	28.90	6	12	2.67
STPA3004	Full Size 4" Deep	EACH	33.43	6	12	4.00
STPA3006	Full Size 6" Deep	EACH	40.54	6	12	4.63
STPA3121	Half Size 1 1/4" Deep	EACH	23.29	12	24	1.96
STPA3122	Half Size 2 1/2" Deep	EACH	31.50	12	24	1.96
STPA3122L	Half Size Long 2 1/2" Deep	EACH	31.04	12	24	2.20
STPA3124	Half Size 4" Deep	EACH	38.40	6	24	4.00
STPA3124L	Half Size Long 4" Deep	EACH	19.27	6	12	2.20
STPA3126	Half Size 6" Deep	EACH	22.64	6	12	2.47
STPA3126L	Half Size Long 6" Deep	EACH	22.92	6	12	2.56
STPA3132	Third Size 2 1/2" Deep	EACH	45.80	12	48	2.96
STPA3134	Third Size 4" Deep	EACH	26.94	12	24	2.21
STPA3136	Third Size 6" Deep	EACH	34.82	12	24	2.46
STPA3142	Quarter Size 2 1/2" Deep	EACH	53.74	12	72	3.47
STPA3144	Quarter Size 4" Deep	EACH	43.65	12	48	3.46
STPA3146	Quarter Size 6" Deep	EACH	28.91	12	24	1.92
STPA3162	Sixth Size 2 1/2" Deep	EACH	36.03	12	72	2.50
STPA3164	Sixth Size 4" Deep	EACH	30.06	12	48	2.42
STPA3166	Sixth Size 6" Deep	EACH	40.27	12	48	2.58
STPA3192	Ninth Size 2 1/2" Deep	EACH	26.13	12	72	1.84
STPA3194	Ninth Size 4" Deep	EACH	35.95	12	72	2.73
STPA3232	Two-Thirds Size 2 1/2" Deep	EACH	41.00	12	24	2.62
STPA3234	Two-Thirds Size 4" Deep	EACH	47.15	12	24	4.00
STPA3236	Two-Thirds Size 6" Deep	EACH	28.46	6	12	3.14

18/8 **SS** STAINLESS STEEL **NSF**

24 TRUE GAUGE



STPA3132



STPA3236

25 GAUGE ANTI-JAM STEAM PANS

ITEM	DESCRIPTION	U/M	WEIGHT GROSS lbs	INNER PACK	MASTER PACK	CU. FT.
STPA4002	Full Size 2½" Deep	EACH	29.61	6	12	2.60
STPA4004	Full Size 4" Deep	EACH	35.03	6	12	4.00
STPA4006	Full Size 6" Deep	EACH	40.03	6	12	4.63
STPA4122	Half Size 2½" Deep	EACH	33.33	12	24	1.96
STPA4124	Half Size 4" Deep	EACH	41.25	6	24	4.00
STPA4126	Half Size 6" Deep	EACH	24.23	6	12	2.47
STPA4132	Third Size 2½" Deep	EACH	45.72	12	48	2.33
STPA4134	Third Size 4" Deep	EACH	27.68	12	24	2.06
STPA4136	Third Size 6" Deep	EACH	36.31	12	24	2.36
STPA4142	Quarter Size 2½" Deep	EACH	56.25	12	72	2.91
STPA4144	Quarter Size 4" Deep	EACH	46.43	12	48	3.46
STPA4146	Quarter Size 6" Deep	EACH	29.35	12	24	1.92
STPA4162	Sixth Size 2½" Deep	EACH	38.75	12	72	2.02
STPA4164	Sixth Size 4" Deep	EACH	33.33	12	48	2.42
STPA4166	Sixth Size 6" Deep	EACH	42.03	12	48	2.58
STPA4192	Ninth Size 2½" Deep	EACH	26.79	12	72	1.61
STPA4194	Ninth Size 4" Deep	EACH	37.86	12	72	2.49

18/8 **SS** STAINLESS STEEL

25 TRUE GAUGE



STPA4164

STEAM PAN COVER

Reinforced edges prevent bending, and fit tightly on steam pans.

ITEM	DESCRIPTION	U/M	WEIGHT GROSS lbs	INNER PACK	MASTER PACK	CU. FT.
STPA5000C	Full Size Solid Cover	EACH	45.44	12	24	3.65
STPA5000CS	Full Size Slotted Cover	EACH	45.02	12	24	3.65
STPA5120C	Half Size Solid Cover	EACH	44.69	12	48	3.78
STPA5120CL	Half Size Long Solid Cover	EACH	23.67	12	24	1.98
STPA5120CS	Half Size Slotted Cover	EACH	44.29	12	48	3.78
STPA5120CSL	Half Size Long Slotted Cover	EACH	23.12	12	24	1.98
STPA5130C	Third Size Solid Cover	EACH	45.88	12	72	3.66
STPA5130CS	Third Size Slotted Cover	EACH	45.07	12	72	3.66
STPA5140C	Quarter Size Solid Cover	EACH	35.29	12	72	3.03
STPA5140CS	Quarter Size Slotted Cover	EACH	34.26	12	72	3.03
STPA5160C	Sixth Size Solid Cover	EACH	23.30	12	72	2.33
STPA5160CS	Sixth Size Slotted Cover	EACH	22.85	12	72	2.33
STPA5190C	Ninth Size Solid Cover	EACH	16.32	12	72	1.55
STPA5190CS	Ninth Size Slotted Cover	EACH	15.87	12	72	1.55
STPA5230C	Two-Thirds Size Solid Cover	EACH	30.26	12	24	2.43
STPA5230CS	Two-Thirds Size Slotted Cover	EACH	29.72	12	24	2.43

STPA5140CS
Quarter Size

18/8 **SS** STAINLESS STEEL

24 TRUE GAUGE



STPA5000CS
Full Size



STPA5130CS
Third Size



STPA5120CS
Half Size

PERFORATED STEAM PAN

ITEM	DESCRIPTION	U/M	WEIGHT GROSS lbs	INNER PACK	MASTER PACK	CU. FT.
STPA3001PF	Full Size 1¼" Deep	EACH	22.31	6	12	1.50
STPA3002PF	Full Size 2½" Deep	EACH	26.83	6	12	2.65
STPA3004PF	Full Size 4" Deep	EACH	32.37	6	12	3.25
STPA3006PF	Full Size 6" Deep	EACH	36.71	6	12	3.96
STPA3121PF	Half Size 1¼" Deep	EACH	23.58	12	24	1.60
STPA3122PF	Half Size 2½" Deep	EACH	30.15	12	24	2.44
STPA3124PF	Half Size 4" Deep	EACH	38.71	6	24	3.35
STPA3126PF	Half Size 6" Deep	EACH	22.49	6	12	2.12
STPA3022	Full Size 2½" Deep, Divided	EACH	33.51	6	12	2.65

18/8 **SS** STAINLESS STEEL

24 TRUE GAUGE



STPA3126PF



IRSC001



9007



OW360

SCISSOR

Durable steel blades provide long lasting sharpness. Enclosed in plastic grip handles for greater comfort.

ITEM	DESCRIPTION	U/M	WEIGHT GROSS lbs	INNER PACK	MASTER PACK	CU. FT.
IRSC001	7¾"	DOZEN	52.91	1	12	1.15
9007	4"	DOZEN	26.00	1	12	1.46

Made in Taiwan

VEGETABLE SHREDDER

Manual vegetable shredder with turn lever. Comes with 3 shred pattern blades. Stainless steel grater riveted on colored plastic handle.

ITEM	DESCRIPTION	U/M	WEIGHT GROSS lbs	INNER PACK	MASTER PACK	CU. FT.
JAS022006	10¾" x 4¾" 6¾"	EACH	15.43	1	8	2.30
Grater						
PLVS001	15" x 3" Grater, Large	EACH	54.01	12	240	4.18
PLVS002	12¼" x 2¾" Grater, Medium	EACH	41.89	12	240	2.95
PLVS003	10½" x 2½" Grater, Small	EACH	30.12	12	240	2.13
OW360	Multi-Use Slicer	EACH	42.09	12	120	3.84



PLVS001

PLVS002

PLVS003

* PLVS Comes in assorted colors



JAS022006

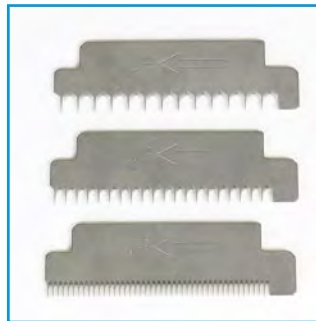

SLMLB002

MELON BALLER

Stainless steel mini scoopers fastened onto a wooden handle.

ITEM	DESCRIPTION	U/M	WEIGHT GROSS lbs	INNER PACK	MASTER PACK	CU. FT.
SLMLB002	7" x 1¾" x 5/16" With Wooden Center Grip	EACH	14.30	36	144	0.45

ADAPTOR BAR

ITEM	DESCRIPTION	U/M	WEIGHT GROSS lbs	INNER PACK	MASTER PACK	CU. FT.
SLTHAB012	12" x 1" x 3/8" Adaptor Bar w/Groove	EACH	28.00	24	144	0.51
SLTHAB020	20" x 1" x 3/8" Adaptor Bar w/Groove	EACH	37.48	24	120	0.73
SLTHAB012D	12" x 1" x 1/2" Adaptor Bar	EACH	26.62	24	144	0.60
SLTHAB020D	20" x 1" x 1/2" Adaptor Bar	EACH	36.70	24	120	0.99

Made in Taiwan

Made in Taiwan

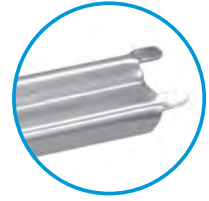

SLTHAB012
STEAM PAN & WATER PAN
SOLD SEPERATELY



SLTHAB012

SLTHAB020D

SLTHAB012D

FUNNEL

ITEM	DESCRIPTION	U/M	WEIGHT GROSS lbs	INNER PACK	MASTER PACK	CU. FT.
Plastic						
*15 mm tube's outer diameter.						
PLFN004	4 1/8" Diameter, 8 oz, Tube Diameter = 0.6"	EACH	19.14	12	360	3.02
PLFN005	5 1/4" Diameter, 12 oz, Tube Diameter = 0.6"	EACH	23.80	12	360	4.62
PLFN006	6 1/4" Diameter, 22 oz, Tube Diameter = 0.6"	EACH	35.00	12	360	5.93
Stainless Steel						
*17 mm tube's outer diameter. Removable strainer						
SLFN005	5" Diameter x 5 7/8" Length, 11 1/2 oz	EACH	9.70	1	36	3.40
SLFN006	6" Diameter x 6 3/4" Length, 18 oz	EACH	14.00	1	36	4.29

Made in Taiwan

Made in Taiwan

Made in Taiwan

SS STAINLESS STEEL



PLFN004



PLFN005



PLFN006



SLFN005



SLFN006



SLIC001

INSET COVER - DIVIDED

- * Plastic Knob
- * Notch on side for ladle



ITEM	DESCRIPTION	U/M	WEIGHT GROSS lbs	INNER PACK	MASTER PACK	CU. FT.
SLIC001	10" Diameter, 7 qt	EACH	22.05	6	24	2.75
SLIC002	12" Diameter, 11 qt	EACH	29.76	6	24	3.73



ALWP001

WATER PAN



ITEM	DESCRIPTION	U/M	WEIGHT GROSS lbs	INNER PACK	MASTER PACK	CU. FT.
ALWP001	25 qt 20 ³ / ₄ " x 12 ³ / ₄ " x 6 ¹ / ₂ ", 1mm	EACH	15.87	6	6	2.24



SLSPG001

SPILLAGE PAN



ITEM	DESCRIPTION	U/M	WEIGHT GROSS lbs	INNER PACK	MASTER PACK	CU. FT.
SLSPG001	25 qt 21" x 13" x 6", 0.7mm	EACH	24.25	6	6	2.72



SLTHFB010

FALSE BOTTOM

For use with steam table pans. Holds foods above pan bottom for draining.



ITEM	DESCRIPTION	U/M	WEIGHT GROSS lbs	INNER PACK	MASTER PACK	CU. FT.
SLTHFB010	10 ¹ / ₂ " x 8 ¹ / ₄ " x ³ / ₈ "	EACH	26.46	1	24	0.77
SLTHFB017	17" x 8 ³ / ₄ " x ³ / ₈ "	EACH	47.40	1	24	1.50



SLPHAP068

ADAPTOR PLATE



ITEM	DESCRIPTION	U/M	WEIGHT GROSS lbs	INNER PACK	MASTER PACK	CU. FT.
SLPHAP066	Two 6 ¹ / ₂ " Holes Fits 4 qt Inset Pans 20 ³ / ₁₆ " x 12 ⁷ / ₈ "	EACH	57.00	1	24	0.55
SLPHAP068	One 6 ¹ / ₂ ", & One 8 ¹ / ₂ " Hole Fits 4 qt & 7 qt Inset Pans 20 ³ / ₁₆ " x 12 ⁷ / ₈ "	EACH	49.00	1	24	0.55
SLPHAP088	Two 8 ¹ / ₂ " Holes Fits 7 qt Inset Pans 20 ³ / ₁₆ " x 12 ⁷ / ₈ "	EACH	43.00	1	24	0.55

BAIN MARIE POT & COVER

Polished exterior and satin interior. Stackable cover fits perfectly on pot.



ITEM	DESCRIPTION	U/M	WEIGHT GROSS lbs	INNER PACK	MASTER PACK	CU. FT.
Pot						
SLBM001	1½ qt Bain Marie Pot 4⅞" Diameter x 5¼" Height	EACH	15.40	6	24	1.48
SLBM002	2 qt Bain Marie Pot 4⅞" Diameter x 6¼" Height	EACH	20.13	6	24	2.15
SLBM003	3½ qt Bain Marie Pot 7" Diameter x 7¾" Height	EACH	26.75	6	24	3.28
SLBM004	4¼ qt Bain Marie Pot 7⅞" Diameter x 7¾" Height	EACH	17.35	6	12	1.46
SLBM005	6 qt Bain Marie Pot 8" Diameter x 8½" Height	EACH	22.45	6	12	4.57
SLBM006	8¼ qt Bain Marie Pot 8⅞" Diameter x 9¾" Height	EACH	26.60	6	12	5.68
Cover						
SLBM007	Fits 1½ qt, SLBM001	EACH	26.86	12	144	1.78
SLBM008	Fits 2 qt, SLBM001	EACH	32.89	12	144	2.03
SLBM009	Fits 3½ qt, SLBM001	EACH	44.95	12	144	3.63
SLBM010	Fits 4¼ qt, SLBM001	EACH	27.02	12	72	2.17
SLBM011	Fits 6 qt SLBM001	EACH	30.83	6	72	3.79
SLBM012	Fits 8¼ qt SLBM001	EACH	25.27	6	48	2.06

*** IMPROVED ***

COVER
SLBM007 ~ SLBM012



POT
SLBM001 ~ SLBM006

INSET PAN & COVER

Mirror-polished exterior and satin finish interior.



ITEM	DESCRIPTION	U/M	WEIGHT GROSS lbs	INNER PACK	MASTER PACK	CU. FT.
Pan						
SLIP001	2½ qt Inset Pan 5⅞" Diameter x 7½" Height	EACH	27.50	6	36	2.31
SLIP002	4 qt Inset Pan 7⅞" Diameter x 8" Height	EACH	45.24	6	36	4.37
SLIP003	7 qt Inset Pan 9½" Diameter x 8¼" Height	EACH	40.13	6	24	4.42
SLIP004	11 qt Inset Pan 11⅞" Diameter x 8" Height	EACH	54.21	6	24	6.14
Cover						
SLIP005	Fits 2½ qt, SLIP001	EACH	19.29	6	72	1.02
SLIP006	Fits 4 qt, SLIP002	EACH	30.24	6	72	1.56
SLIP007	Fits 7 qt, SLIP003	EACH	31.88	6	48	1.78
SLIP008	Fits 11 qt, SLIP004	EACH	32.78	6	36	2.67

COVER
SLIP005 ~ SLIP008



INSET PAN
SLIP001 ~ SLIP004

PAIL

With swing handle.



ITEM	DESCRIPTION	U/M	WEIGHT GROSS lbs	INNER PACK	MASTER PACK	CU. FT.
SLPAL002	2 qt, 6½" Diameter x 6¼" Height w/3½" handle Length	EACH	49.50	12	72	2.93
SLPAL006	6 qt, 8⅞" Diameter x 9½" Height w/5" handle Length	EACH	37.04	12	24	2.11
SLPAL009	9 qt, 10" Diameter x 10¼" Height w/5" handle Length	EACH	23.50	12	12	1.22
SLPAL013	13 qt, 11⅞" Diameter x 11" Height w/6" handle Length	EACH	27.60	12	12	1.59



SLPAL002 ~ SLPAL013

2024

FOOD PREPARATION

ROUND FOOD STORAGE CONTAINERS

CLEAR



ITEM	DESCRIPTION	U/M	WEIGHT GROSS lbs	INNER PACK	MASTER PACK	CU. FT.
PLRFT301PC	1 qt, 5 1/2" Diameter x 5" Height	EACH	19.73	6	48	2.35
PLRFT302PC	2 qt, 7 3/8" Diameter x 4 1/4" Height	EACH	15.26	12	24	2.02
PLRFT304PC	4 qt, 7 3/8" Diameter x 8 1/2" Height	EACH	11.93	12	12	1.31
PLRFT306PC	6 qt, 8 5/8" Diameter x 7 5/8" Height	EACH	12.57	12	12	1.84
PLRFT308PC	8 qt, 8 5/8" Diameter x 10 5/8" Height	EACH	16.36	12	12	2.21
PLRFT312PC	12 qt, 12 3/8" Diameter x 8 3/4" Height	EACH	23.88	12	12	4.16
PLRFT318PC	18 qt, 12 3/8" Diameter x 12" Height	EACH	16.36	6	6	2.81
PLRFT322PC	22 qt, 12 3/8" Diameter x 14 3/8" Height	EACH	20.08	6	6	3.40

TRANSLUCENT



ITEM	DESCRIPTION	U/M	WEIGHT GROSS lbs	INNER PACK	MASTER PACK	CU. FT.
PLRFT301TL	1 qt, 5 1/2" Diameter x 5" Height	EACH	19.73	6	48	2.35
PLRFT302TL	2 qt, 7 3/8" Diameter x 4 1/4" Height	EACH	15.26	12	24	2.02
PLRFT304TL	4 qt, 7 3/8" Diameter x 8 1/2" Height	EACH	11.93	12	12	1.31
PLRFT306TL	6 qt, 8 5/8" Diameter x 7 5/8" Height	EACH	12.57	12	12	1.84
PLRFT308TL	8 qt, 8 5/8" Diameter x 10 5/8" Height	EACH	16.36	12	12	2.21
PLRFT312TL	12 qt, 12 3/8" Diameter x 8 3/4" Height	EACH	23.88	12	12	4.16
PLRFT318TL	18 qt, 12 3/8" Diameter x 12" Height	EACH	16.36	6	6	2.81
PLRFT322TL	22 qt, 12 3/8" Diameter x 14 3/8" Height	EACH	20.08	6	6	3.40

WHITE



POLYPROPYLENE

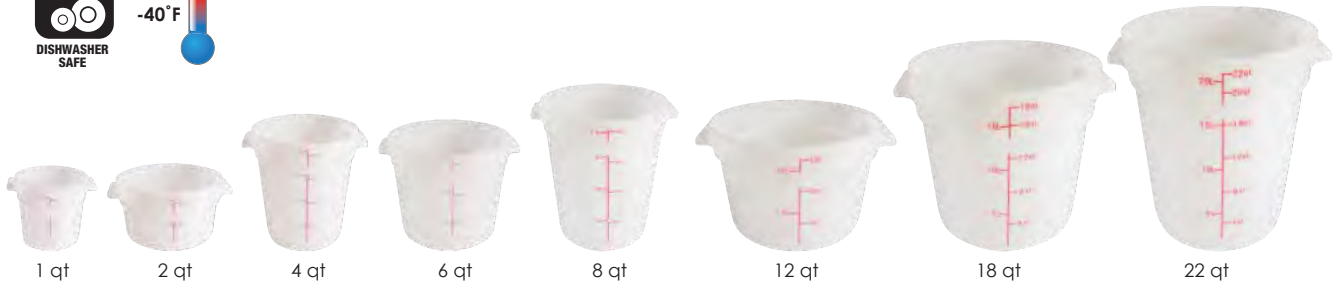

ITEM	DESCRIPTION	U/M	WEIGHT GROSS lbs	INNER PACK	MASTER PACK	CU. FT.
PLRFT301PP	1 qt, 5 1/8" Diameter x 5" Height	EACH	19.73	6	48	2.35
PLRFT302PP	2 qt, 7 3/8" Diameter x 4 1/4" Height	EACH	15.26	12	24	2.02
PLRFT304PP	4 qt, 7 7/8" Diameter x 8 1/2" Height	EACH	11.93	12	12	1.31
PLRFT306PP	6 qt, 8 3/8" Diameter x 7 5/8" Height	EACH	12.57	12	12	1.84
PLRFT308PP	8 qt, 8 7/8" Diameter x 10 1/8" Height	EACH	16.36	12	12	2.21
PLRFT312PP	12 qt, 12 3/8" Diameter x 8 3/4" Height	EACH	23.88	12	12	4.16
PLRFT318PP	18 qt, 12 3/8" Diameter x 12" Height	EACH	16.36	6	6	2.81
PLRFT322PP	22 qt, 12 3/8" Diameter x 14 7/8" Height	EACH	20.08	6	6	3.40

LIDS



ITEM	DESCRIPTION	U/M	WEIGHT GROSS lbs	INNER PACK	MASTER PACK	CU. FT.
White						
PLRFC0001PP	Fits 1 qt, PLRFT301PP	EACH	1.32	12	12	0.10
PLRFC0204PP	Fits 2 & 4 qt, PLRFT302PP & 304PP	EACH	5.00	12	12	0.25
PLRFC0608PP	Fits 6 & 8 qt, PLRFT306PP & 308PP	EACH	4.12	12	12	0.41
PLRFC121822PP	Fits 12, 18 & 22 qt, PLRFT312, 318, 322PP	EACH	4.96	6	6	0.45
Translucent						
PLRFC0001TL	Fits 1 qt, PLRFT301TL	EACH	1.32	12	12	0.10
PLRFC0204TL	Fits 2 & 4 qt, PLRFT302TL & PLRFT304TL	EACH	5.00	12	12	0.25
PLRFC0608TL	Fits 6 & 8 qt, PLRFT306TL & PLRFT308TL	EACH	4.12	12	12	0.41
PLRFC121822TL	Fits 12, 18 & 22 qt, PLRFT312TL, PLRFT-318TL & PLRFT322TL	EACH	4.96	6	6	0.45
Clear						
PLRFC0001PC	Fits 1 qt, PLRFT301PC	EACH	1.32	12	12	0.10
PLRFC0204PC	Fits 2 & 4 qt, PLRFT302PC & PLRFT304PC	EACH	5.00	12	12	0.25
PLRFC0608PC	Fits 6 & 8 qt, PLRFT306PC & PLRFT308PC	EACH	4.12	12	12	0.41
PLRFC121822PC	Fits 12, 18 & 22 qt, PLRFT312PC, PLRFT318PC & PLRFT322PC	EACH	4.96	6	6	0.45

SQUARE FOOD STORAGE CONTAINERS

CLEAR (POLYCARBONATE)



SHATTER RESISTANT



SCRATCH RESISTANT



DISHWASHER SAFE

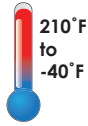

*Lids Sold Separately

ITEM	DESCRIPTION	U/M	WEIGHT GROSS lbs	INNER PACK	MASTER PACK	CU. FT.
PLSFT002PC	2 qt, 7 ¹ / ₁₆ " x 7" x 4"	EACH	16.31	6	24	2.05
PLSFT004PC	4 qt, 7 ¹ / ₁₆ " x 7" x 7 ¹ / ₂ "	EACH	24.12	6	24	2.84
PLSFT006PC	6 qt, 8 ⁷ / ₁₆ " x 8 ⁷ / ₁₆ " x 7 ¹ / ₂ "	EACH	35.58	6	24	4.57
PLSFT008PC	8 qt, 8 ⁷ / ₁₆ " x 8 ⁷ / ₁₆ " x 9"	EACH	41.38	6	24	4.96
PLSFT012PC	12 qt, 11 ¹ / ₄ " x 11 ³ / ₈ " x 8 ¹ / ₄ "	EACH	32.25	6	12	4.02
PLSFT018PC	18 qt, 11 ¹ / ₄ " x 11 ³ / ₈ " x 12 ³ / ₈ "	EACH	41.36	6	12	4.72
PLSFT022PC	22 qt, 11 ¹ / ₄ " x 11 ³ / ₈ " x 15 ³ / ₄ "	EACH	49.85	6	12	5.37

TRANSLUCENT (POLYPROPYLENE)



DISHWASHER SAFE

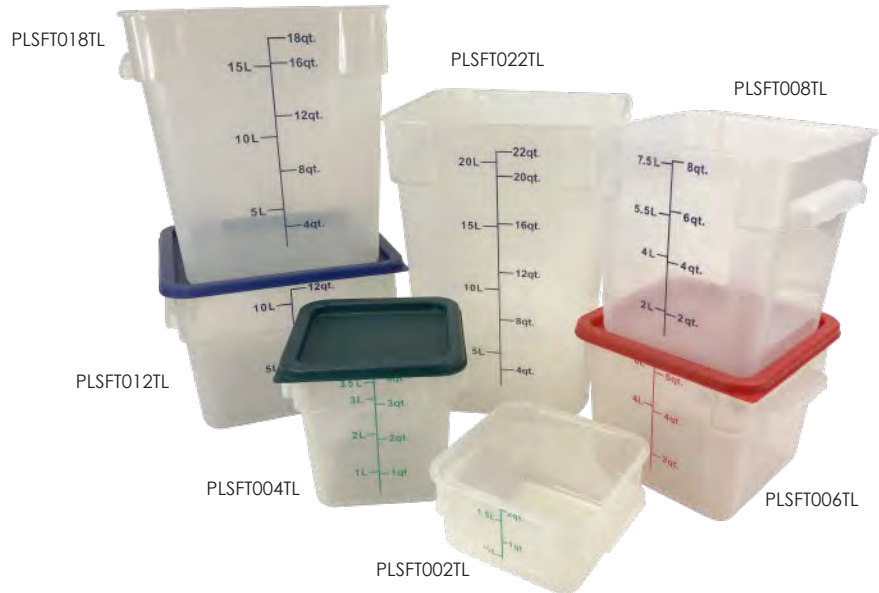

ITEM	DESCRIPTION	U/M	WEIGHT GROSS lbs	INNER PACK	MASTER PACK	CU. FT.
PLSFT002TL	2 qt, 7 ¹ / ₁₆ " x 7" x 4"	EACH	13.29	6	24	2.05
PLSFT004TL	4 qt, 7 ¹ / ₁₆ " x 7" x 7 ¹ / ₂ "	EACH	19.07	6	24	2.85
PLSFT006TL	6 qt, 8 ⁷ / ₁₆ " x 8 ⁷ / ₁₆ " x 7 ¹ / ₂ "	EACH	27.82	6	24	4.55
PLSFT008TL	8 qt, 8 ⁷ / ₁₆ " x 8 ⁷ / ₁₆ " x 9"	EACH	26.19	6	24	4.96
PLSFT012TL	12 qt, 11 ¹ / ₄ " x 11 ³ / ₈ " x 8 ¹ / ₄ "	EACH	23.57	6	12	4.02
PLSFT018TL	18 qt, 11 ¹ / ₄ " x 11 ³ / ₈ " x 12 ³ / ₈ "	EACH	30.31	6	12	4.72
PLSFT022TL	22 qt, 11 ¹ / ₄ " x 11 ³ / ₈ " x 15 ³ / ₄ "	EACH	39.55	6	12	5.37



**WHITE
(POLYPROPYLENE)**



*Lids Sold separately

ITEM	DESCRIPTION	U/M	WEIGHT GROSS lbs	INNER PACK	MASTER PACK	CU. FT.
PLSFT002PP	2 qt, 7 ¹ / ₆ " x 7" x 4"	EACH	13.29	6	24	2.05
PLSFT004PP	4 qt, 7 ¹ / ₆ " x 7" x 7 ¹ / ₂ "	EACH	19.07	6	24	2.85
PLSFT006PP	6 qt, 8 ⁷ / ₈ " x 8 ⁷ / ₈ " x 7 ¹ / ₂ "	EACH	27.82	6	24	4.55
PLSFT008PP	8 qt, 8 ⁷ / ₈ " x 8 ⁷ / ₈ " x 9"	EACH	26.19	6	24	4.96
PLSFT012PP	12 qt, 11 ¹ / ₄ " x 11 ³ / ₈ " x 8 ¹ / ₄ "	EACH	23.57	6	12	4.02
PLSFT018PP	18 qt, 11 ¹ / ₄ " x 11 ³ / ₈ " x 12 ³ / ₈ "	EACH	30.31	6	12	4.72
PLSFT022PP	22 qt, 11 ¹ / ₄ " x 11 ³ / ₈ " x 15 ³ / ₄ "	EACH	39.55	6	12	5.37

SQUARE LID

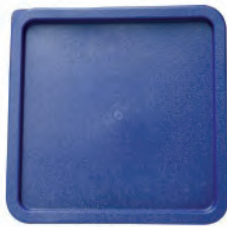

PLSFT121822C



PLSFT0608C



PLSFT0204C

ITEM	DESCRIPTION	U/M	WEIGHT GROSS lbs	INNER PACK	MASTER PACK	CU. FT.
PLSFT0204C	Fits 2 qt & 4 qt Green, PLSFT002 & PLSFT004 (PC/TL/PP)	EACH	3.26	6	12	0.31
PLSFT0608C	Fits 6 qt & 8 qt Red, PLSFT006 & PLSFT008(PC/TL/PP)	EACH	4.50	6	12	0.43
PLSFT121822C	Fits 12 qt, 18 qt & 22 qt Blue, PLSFT012, PLSFT018 & PLSFT022 (PC/TL/PP)	EACH	7.54	6	12	0.73

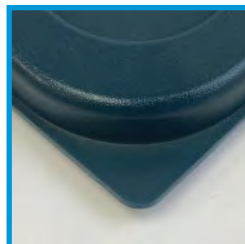

non-slip texture

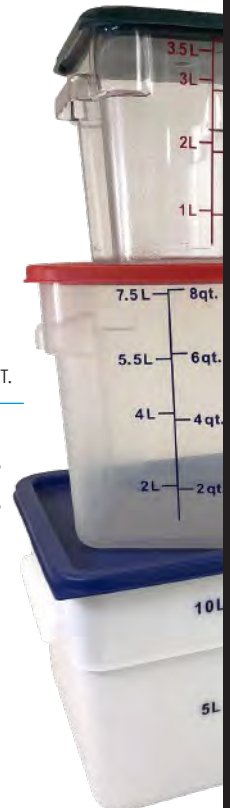



POLYCARBONATE FOOD PAN - CLEAR

Lids and drain shelves are sold separately.

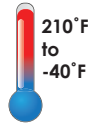

ITEM	DESCRIPTION	U/M	WEIGHT GROSS lbs	INNER PACK	MASTER PACK	CU. FT.
PLPA8002	Full Size 2 1/2" Deep	EACH	25.18	6	12	3.10
PLPA8004	Full Size 4" Deep	EACH	29.87	6	12	4.00
PLPA8006	Full Size 6" Deep	EACH	36.68	6	12	4.85
PLPA8008	Full Size 8" Deep	EACH	48.63	6	12	5.90
PLPA8122	Half Size 2 1/2" Deep	EACH	24.47	12	24	2.71
PLPA8124	Half Size 4" Deep	EACH	31.08	6	24	3.93
PLPA8126	Half Size 6" Deep	EACH	20.50	6	12	2.54
PLPA8128	Half Size 8" Deep	EACH	22.71	6	12	3.00
PLPA8122L	Half Size Long 2 1/2" Deep	EACH	20.94	6	24	2.10
PLPA8124L	Half Size Long 4" Deep	EACH	13.89	6	12	1.38
PLPA8132	Third Size 2 1/2" Deep	EACH	16.98	12	24	1.93
PLPA8134	Third Size 4" Deep	EACH	21.61	12	24	2.40
PLPA8136	Third Size 6" Deep	EACH	33.51	6	24	3.59
PLPA8138	Third Size 8" Deep	EACH	19.40	6	12	2.10
PLPA8142	Quarter Size 2 1/2" Deep	EACH	21.83	6	36	2.59
PLPA8144	Quarter Size 4" Deep	EACH	23.59	6	36	2.96
PLPA8146	Quarter Size 6" Deep	EACH	21.61	6	24	2.53
PLPA8162	Sixth Size 2 1/2" Deep	EACH	13.23	12	36	1.39
PLPA8164	Sixth Size 4" Deep	EACH	21.16	12	48	2.29
PLPA8166	Sixth Size 6" Deep	EACH	14.99	6	24	1.71
PLPA8192	Ninth Size 2 1/2" Deep	EACH	16.09	12	72	1.80
PLPA8194	Ninth Size 4" Deep	EACH	21.38	12	72	2.40

2 1/2", 4", 6", 8"
Depth Available



POLYCARBONATE FOOD PAN LID

The clear lid makes it easy to view contents inside the food pans. Rigid built-in handle provides a secure grip.



ITEM	DESCRIPTION	U/M	WEIGHT GROSS lbs	INNER PACK	MASTER PACK	CU. FT.
Solid						
PLPA7000C	Full Size Solid Lid	EACH	34.17	12	24	2.44
PLPA7120C	Half Size Solid Lid	EACH	33.73	12	48	2.78
PLPA7120LC	Half Size Long Solid Lid	EACH	15.43	12	24	1.19
PLPA7130C	Third Size Solid Lid	EACH	31.53	12	72	3.00
PLPA7140C	Quarter Size Solid Lid	EACH	26.46	12	72	2.39
PLPA7160C	Sixth Size Solid Lid	EACH	20.28	12	72	1.61
PLPA7190C	Ninth Size Solid Lid	EACH	13.56	12	72	0.65
Slotted						
PLPA7000CS	Full Size Slotted Lid	EACH	34.17	12	24	2.44
PLPA7120CS	Half Size Slotted Lid	EACH	33.73	12	48	2.78
PLPA7130CS	Third Size Slotted Lid	EACH	31.53	12	72	3.00
PLPA7140CS	Quarter Size Slotted Lid	EACH	26.46	12	72	2.39
PLPA7160CS	Sixth Size Slotted Lid	EACH	20.28	12	72	1.61
PLPA7190CS	Ninth Size Slotted Lid	EACH	13.56	12	72	0.65



PLPA7000CS



PLPA7000C



PLPA7120CS



PLPA7140C



PLPA7140CS



PLPA7120DS

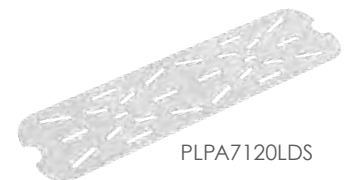

PLPA7120LDS



PLPA7160DS

POLYCARBONATE FOOD PAN DRAIN SHELF

The sturdy feet help to support contents and allow room for easy drainage.



ITEM	DESCRIPTION	U/M	WEIGHT GROSS lbs	INNER PACK	MASTER PACK	CU. FT.
PLPA7000DS	Full size	EACH	26.01	10	20	2.01
PLPA7120DS	Half size	EACH	9.92	10	20	0.72
PLPA7120LDS	Half Size Long	EACH	6.17	10	20	0.66
PLPA7130DS	Third size	EACH	13.67	20	40	1.04
PLPA7140DS	Quarter size	EACH	6.83	20	40	0.69
PLPA7160DS	Sixth size	EACH	5.73	20	60	0.64



POLYCARBONATE FOOD PAN - BLACK

Lids and drain shelves are sold separately.

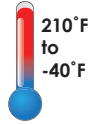

ITEM	DESCRIPTION	U/M	WEIGHT GROSS lbs	INNER PACK	MASTER PACK	CU. FT.
PLPA8002BK	Full Size 2 1/2" Deep	EACH	25.18	6	12	3.10
PLPA8004BK	Full Size 4" Deep	EACH	29.87	6	12	4.00
PLPA8006BK	Full Size 6" Deep	EACH	36.68	6	12	4.85
PLPA8008BK	Full Size 8" Deep	EACH	48.63	6	12	5.90
PLPA8122BK	Half Size 2 1/2" Deep	EACH	24.47	12	24	2.71
PLPA8124BK	Half Size 4" Deep	EACH	31.08	6	24	3.93
PLPA8126BK	Half Size 6" Deep	EACH	20.5	6	12	2.54
PLPA8128BK	Half Size 8" Deep	EACH	22.71	6	12	3.00
PLPA8122LBK	Half Size Long 2 1/2" Deep	EACH	20.94	6	24	2.10
PLPA8124LBK	Half Size Long 4" Deep	EACH	13.89	6	12	1.38
PLPA8132BK	Third Size 2 1/2" Deep	EACH	16.98	12	24	1.93
PLPA8134BK	Third Size 4" Deep	EACH	21.61	12	24	2.40
PLPA8136BK	Third Size 6" Deep	EACH	33.51	6	24	3.59
PLPA8138BK	Third Size 8" Deep	EACH	19.4	6	12	2.10
PLPA8142BK	Quarter Size 2 1/2" Deep	EACH	21.83	6	36	2.59
PLPA8144BK	Quarter Size 4" Deep	EACH	23.59	6	36	2.96
PLPA8146BK	Quarter Size 6" Deep	EACH	21.61	6	24	2.53
PLPA8162BK	Sixth Size 2 1/2" Deep	EACH	13.23	12	36	1.39
PLPA8164BK	Sixth Size 4" Deep	EACH	21.16	12	48	2.29
PLPA8166BK	Sixth Size 6" Deep	EACH	14.99	6	24	1.71
PLPA8192BK	Ninth Size 2 1/2" Deep	EACH	16.09	12	72	1.80
PLPA8194BK	Ninth Size 4" Deep	EACH	21.38	12	72	2.40

2 1/2", 4", 6", 8"
Depth Available



POLYCARBONATE FOOD PAN LID - BLACK



SHATTER RESISTANT



SCRATCH RESISTANT



DISHWASHER SAFE



POLYCARBONATE



ITEM	DESCRIPTION	U/M	WEIGHT GROSS lbs	INNER PACK	MASTER PACK	CU. FT.
Solid						
PLPA7000CBK	Full Size Solid Lid	EACH	34.17	12	24	2.44
PLPA7120CBK	Half Size Solid Lid	EACH	33.73	12	48	2.78
PLPA7120LCBK	Half Size Long Solid Lid	EACH	15.43	12	24	1.19
PLPA7130CBK	Third Size Solid Lid	EACH	31.53	12	72	3.00
PLPA7140CBK	Quarter Size Solid Lid	EACH	26.46	12	72	2.39
PLPA7160CBK	Sixth Size Solid Lid	EACH	20.28	12	72	1.61
PLPA7190CBK	Ninth Size Solid Lid	EACH	13.56	12	72	0.65
Slotted						
PLPA7000CSBK	Full Size Slotted Lid	EACH	34.17	12	24	2.44
PLPA7120CSBK	Half Size Slotted Lid	EACH	33.73	12	48	2.78
PLPA7130CSBK	Third Size Slotted Lid	EACH	31.53	12	72	3.00
PLPA7140CSBK	Quarter Size Slotted Lid	EACH	26.46	12	72	2.39
PLPA7160CSBK	Sixth Size Slotted Lid	EACH	20.28	12	72	1.61
PLPA7190CSBK	Ninth Size Slotted Lid	EACH	13.56	12	72	0.65



PLPA7000CBK



PLPA7120CSBK



PLPA7120CBK



PLPA7120LCBK



PLPA7160CSBK

POLYCARBONATE FOOD PAN DRAIN SHELF - BLACK

The sturdy feet help to support contents and allow room for easy drainage.



SHATTER RESISTANT



SCRATCH RESISTANT



DISHWASHER SAFE



POLYCARBONATE



ITEM	DESCRIPTION	U/M	WEIGHT GROSS lbs	INNER PACK	MASTER PACK	CU. FT.
PLPA7000DSBK	Full Size	EACH	26.01	10	20	2.01
PLPA7120DSBK	Half Size	EACH	9.92	10	20	0.72
PLPA7120LDSBK	Half Size	EACH	6.17	10	20	0.66
PLPA7130DSBK	Third Size	EACH	13.67	20	40	1.04
PLPA7140DSBK	Quarter Size	EACH	6.83	20	40	0.69
PLPA7160DSBK	Sixth Size	EACH	5.73	20	60	0.64

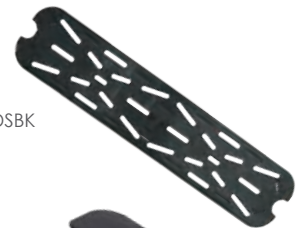

PLPA7120LDSBK



PLPA7120DSBK



PLPA7160DSBK

POLYCARBONATE FOOD STORAGE BOX - CLEAR

12" X 18"

Lids and drain shelves are sold separately.



POLYCARBONATE

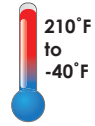

PLFBC1218PC



PLFBD1218PC

12" x 18" comes in 3 sizes of depth:



ITEM	DESCRIPTION	U/M	WEIGHT GROSS lbs	INNER PACK	MASTER PACK	CU. FT.
PLFB121803PC	12" x 18" x 3 1/2", 1.75 Gallon	EACH	22.95	12	12	3.16
PLFB121806PC	12" x 18" x 6", 3 Gallon	EACH	31.78	12	12	3.47
PLFB121809PC	12" x 18" x 9", 4.75 Gallon	EACH	39.37	12	12	3.88
PLFBC1218PC	Lid for 12" x 18"	EACH	16.26	12	12	0.85
PLFBD1218PC	Drain Shelf Fits 12" x 18"	EACH	14.12	24	24	0.78

18" X 26"

Lids and drain shelves are sold separately.



PLFBC1826PC



PLFBD1826PC

18" x 26" comes in 5 sizes of depth:



ITEM	DESCRIPTION	U/M	WEIGHT GROSS lbs	INNER PACK	MASTER PACK	CU. FT.
PLFB182603PC	18" x 26" x 3 1/2", 5 Gallon	EACH	25.42	6	6	3.74
PLFB182606PC	18" x 26" x 6", 8.75 Gallon	EACH	29.87	6	6	4.31
PLFB182609PC	18" x 26" x 9", 13 Gallon	EACH	37.81	6	6	5.24
PLFB182612PC	18" x 26" x 12", 17 Gallon	EACH	46.38	6	6	6.66
PLFB182615PC	18" x 26" x 15", 22 Gallon	EACH	61.94	6	6	8.57
PLFBC1826PC	Lid For 18" x 26"	EACH	32.03	12	12	1.69
PLFBD1826PC	Drain Shelf Fits 18" x 26"	EACH	53.40	24	24	2.05

POLYPROPYLENE FOOD STORAGE BOX - WHITE

12" X 18"



POLYPROPYLENE



LFBC1218PP



PLFBD1218PP

12" x 18" comes in 3 sizes of depth:



ITEM	DESCRIPTION	U/M	WEIGHT GROSS lbs	INNER PACK	MASTER PACK	CU. FT.
PLFB121803PP	12" x 18" x 3 1/2", 1.75 Gallon	EACH	16.2	12	12	3.14
PLFB121806PP	12" x 18" x 6", 3 Gallon	EACH	22.65	12	12	3.46
PLFB121809PP	12" x 18" x 9", 4.75 Gallon	EACH	28.87	12	12	3.88
PLFBC1218PP	Lid For Half Size	EACH	10.66	12	12	0.74
PLFBD1218PP	Drain Shelf Fits 12" x 18"	EACH	10.94	24	24	0.78

18" X 26"



PLFBC1826PP



PLFBD1826PP

18" x 26" comes in 5 sizes of depth:



ITEM	DESCRIPTION	U/M	WEIGHT GROSS lbs	INNER PACK	MASTER PACK	CU. FT.
PLFB182603PP	18" x 26" x 3 1/2", 5 Gallon	EACH	18.68	6	6	3.74
PLFB182606PP	18" x 26" x 6", 8.75 Gallon	EACH	21.67	6	6	4.31
PLFB182609PP	18" x 26" x 9", 13 Gallon	EACH	27.32	6	6	5.23
PLFB182612PP	18" x 26" x 12", 17 Gallon	EACH	33.35	6	6	6.67
PLFB182615PP	18" x 26" x 15", 22 Gallon	EACH	44.74	6	6	8.58
PLFBC1826PP	Lid For Full Size	EACH	23.27	12	12	1.59
PLFBD1826PP	Drain Shelf Fits 18" x 26"	EACH	40.44	24	24	2.05

DOUGH BOX AND COVER

Stackable space-saving design.



POLYPROPYLENE

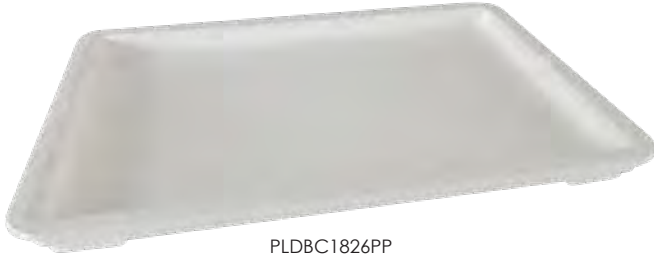

PLDBC1826PP
Cover



PLDB182603PP
3"



PLDB182606PP
6"

ITEM	DESCRIPTION	U/M	WEIGHT GROSS lbs	INNER PACK	MASTER PACK	CU. FT.
PLDB182603PP	18" x 26" x 3"	EACH	22.24	6	6	5.12
PLDB182606PP	18" x 26" x 6"	EACH	31.99	6	6	10.16
PLDBC1826PP	Cover Fits 18" x 26"	EACH	17.00	6	6	2.12

BEVERAGE DISPENSER CONTAINER



POLYPROPYLENE



PLFA006
Leak-proof faucet



Liquid Measurements

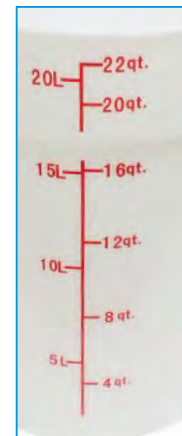

ITEM	DESCRIPTION	U/M	WEIGHT GROSS lbs	INNER PACK	MASTER PACK	CU. FT.
PLBD006PP	6 Gallon Beverage Dispenser With Faucet, 12 $\frac{3}{8}$ " Diameter x 14 $\frac{7}{8}$ " Height	EACH	9.04	4	4	6.85
PLFA006	Faucet For PLBD006PP, 3 $\frac{1}{2}$ " x 1 $\frac{1}{4}$ " x 2 $\frac{5}{8}$ "	EACH	3.22	1	40	0.22



SHELF INGREDIENT BIN

Stackable. Clear flip top lid. Scoop included with build-in holder.



PP POLYPROPYLENE



PLIB002S



PLIB005S



PLIB010S

ITEM	DESCRIPTION	U/M	WEIGHT GROSS lbs	INNER PACK	MASTER PACK	CU. FT.
PLIB002S	2 Gallon/ 40 Cup, 11 ³ / ₄ " x 14 ¹ / ₂ " x 8 ⁵ / ₈ "	EACH	3.97	1	1	1.06
PLIB005S	5 Gallon/ 80 Cup, 11 ³ / ₈ " x 23 ³ / ₈ " x 17"	EACH	11.13	1	1	3.18
PLIB010S	10 Gallon/ 150 Cup, 19 ¹ / ₄ " x 23 ³ / ₈ " x 17"	EACH	17.06	1	1	4.94

INGREDIENT BIN

Two 3" regular casters and two 3" locking casters. Clear sliding lid. Scoop included with build-in hook.



• 21 gal • Holds 160 lbs of sugar or 126 lbs of flour

• 27 gal • Holds 197 lbs of sugar or 154 lbs of flour



PLIB021C



PLIB027C

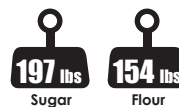
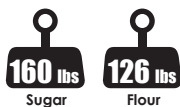

ITEM	DESCRIPTION	U/M	WEIGHT GROSS lbs	INNER PACK	MASTER PACK	CU. FT.
PLIB021C	21 Gallon, 13" x 29 ¹ / ₄ " x 28", w/Casters and Scoop, S/170,F/139	EACH	27.08	1	1	6.11
PLIB027C	27 Gallon, 16 ¹ / ₂ " x 29 ¹ / ₂ " x 28", w/Casters and Scoop, S/207, F/150	EACH	29.95	1	1	7.33
PLCB3150	3" Caster For PLIB021C & PLIB027C	EACH	9.04	4	4	6.85
PLCB3150B	3" Caster With Brake For PLIB021C & CPLIB027C	EACH	9.04	4	4	6.85



PLCB001 ~ PLCB004



PLCB005



PLCB006



PLCB008



PLCB007



CUTTING BOARD

Non-skid surface.



Made in Taiwan



PLCB004, PLCB005 & PLCB006 are NSF listed.



ITEM	DESCRIPTION	U/M	WEIGHT GROSS lbs	INNER PACK	MASTER PACK	CU. FT.
Square						
PLCB001	15" x 9" x 1/2"	EACH	35.49	20	20	0.86
PLCB002	16" x 10" x 1/2"	EACH	43.43	20	20	1.00
PLCB003	17" x 11" x 1/2"	EACH	51.36	20	20	1.20
PLCB004	18" x 12" x 1/2"	EACH	58.42	20	20	1.40
PLCB005	20" x 15" x 1/2"	EACH	49.38	10	10	1.20
PLCB006	24" x 18" x 1/2"	EACH	72.97	10	10	1.60
PLCB008	6" x 10" x 3/8"	EACH	18.30	20	20	0.43
Ping Pong						
PLCB007	13 7/8" x 6 7/8" x 3/8" with Handle	EACH	22.71	20	20	0.65

PLRCB001



PLRCB002



ROUND BOARD - HIGH DENSITY POLYETHYLENE



Made in Taiwan



ITEM	DESCRIPTION	U/M	WEIGHT GROSS lbs	INNER PACK	MASTER PACK	CU. FT.
PLRCB001	14" x 1"	EACH	54.01	10	10	1.37
PLRCB002	14" x 1/2"	EACH	47.40	20	20	1.20

PLCB011 ~ PLCB017
(Heavy Duty)



Made in Taiwan



Made in Taiwan

Made in Taiwan

Made in Taiwan

Made in Taiwan

ITEM	DESCRIPTION	U/M	WEIGHT GROSS lbs	INNER PACK	MASTER PACK	CU. FT.
PLCB011	12" x 18" x 3/4"	EACH	52.25	10	10	1.30
PLCB012	15" x 20" x 3/4"	EACH	36.38	5	5	0.70
PLCB013	18" x 24" x 3/4"	EACH	53.46	5	5	1.00
PLCB014	12" x 18" x 1 1/8"	EACH	43.76	5	5	0.98
PLCB015	15" x 20" x 1 1/8"	EACH	48.50	4	4	1.12
PLCB016	18" x 24" x 1 1/8"	EACH	52.23	3	3	1.27
PLCB017	20" x 30" x 1 1/8"	EACH	48.46	2	2	1.31

POLYETHYLENE COLOR CUTTING BOARDS - HDPE



Made in Taiwan



ITEM	DESCRIPTION	U/M	WEIGHT GROSS lbs	INNER PACK	MASTER PACK	CU. FT.
18" x 12"						
PLCB181205BR	18" x 12" x 1/2" Brown	EACH	22.27	6	6	0.42
PLCB181205BU	18" x 12" x 1/2" Blue	EACH	22.27	6	6	0.42
PLCB181205GR	18" x 12" x 1/2" Green	EACH	22.27	6	6	0.42
PLCB181205RD	18" x 12" x 1/2" Red	EACH	22.27	6	6	0.42
PLCB181205WH	18" x 12" x 1/2" White	EACH	22.27	6	6	0.42
PLCB181205YW	18" x 12" x 1/2" Yellow	EACH	22.27	6	6	0.42
PLCB181205PP	18" x 12" x 1/2" Purple	EACH	22.27	6	6	0.42
20" x 15"						
PLCB201505BR	20" x 15" x 1/2" Brown	EACH	30.86	6	6	0.62
PLCB201505BU	20" x 15" x 1/2" Blue	EACH	30.86	6	6	0.62
PLCB201505GR	20" x 15" x 1/2" Green	EACH	30.86	6	6	0.62
PLCB201505RD	20" x 15" x 1/2" Red	EACH	30.86	6	6	0.62
PLCB201505WH	20" x 15" x 1/2" White	EACH	30.86	6	6	0.62
PLCB201505YW	20" x 15" x 1/2" Yellow	EACH	30.86	6	6	0.62
PLCB201505PP	20" x 15" x 1/2" Purple	EACH	30.86	6	6	0.62
24" x 18"						
PLCB241805BR	24" x 18" x 1/2" Brown	EACH	44.75	6	6	0.86
PLCB241805BU	24" x 18" x 1/2" Blue	EACH	44.75	6	6	0.86
PLCB241805GR	24" x 18" x 1/2" Green	EACH	44.75	6	6	0.86
PLCB241805RD	24" x 18" x 1/2" Red	EACH	44.75	6	6	0.86
PLCB241805WH	24" x 18" x 1/2" White	EACH	44.75	6	6	0.86
PLCB241805YW	24" x 18" x 1/2" Yellow	EACH	44.75	6	6	0.86
PLCB241805PP	24" x 18" x 1/2" Purple	EACH	44.75	6	6	0.86

BR - Brown: Cooked Meat
 BU - Blue: Seafood
 GR - Green: Vegetable
 RD - Red: Raw Meat
 WH - White: All Purpose
 YW - Yellow: Poultry
 PP - Allergen Free



PLCB181205BR ~ PLCB181205PP

POLYETHYLENE COLOR CUTTING BOARD SET - HDPE

Set of 6 Assorted Colors, one each Blue, Brown, Green, Red, White and Yellow



Made in Taiwan



ITEM	DESCRIPTION	U/M	WEIGHT GROSS lbs	INNER PACK	MASTER PACK	CU. FT.
PLCB181205MX	18" x 12" x 1/2" 6 Color Set	SET	22.27	1	1	0.42
PLCB201505MX	20" x 15" x 1/2" 6 Color Set	SET	30.86	1	1	0.62
PLCB241805MX	24" x 18" x 1/2" 6 Color Set	SET	44.75	1	1	0.86

CUTTING BOARD RACK & BRUSH



PLCBBR006



Color matching cutting boards available



PLCBB02BR



PLCBB02BU



PLCBB02GR



PLCBB02RD



PLCBB02WH



PLCBB02YW

ITEM	DESCRIPTION	U/M	WEIGHT GROSS lbs	INNER PACK	MASTER PACK	CU. FT.
Board Rack Powder coated black wire with hooks						
PLCBBR006	12" x 9 1/4" x 10 1/4" H	EACH	23.37	6	6	1.91
Brushes 6" x 2 1/2" x 2" H						
PLCBB02BR	Brown	EACH	23.10	12	72	1.65
PLCBB02BU	Blue	EACH	23.10	12	72	1.65
PLCBB02GR	Green	EACH	23.10	12	72	1.65
PLCBB02RD	Red	EACH	23.10	12	72	1.65
PLCBB02WH	White	EACH	23.10	12	72	1.65
PLCBB02YW	Yellow	EACH	23.10	12	72	1.65

Made in Taiwan

PIZZA RACK

Chrome plated wire pizza pan rack.

ITEM	DESCRIPTION	U/M	WEIGHT GROSS lbs	INNER PACK	MASTER PACK	CU. FT.
CRPT1015	15 Tier Pizza Pan Rack, Welded, Chrome 12" x 12" x 27 3/4"	EACH	13.84	1	2	2.56

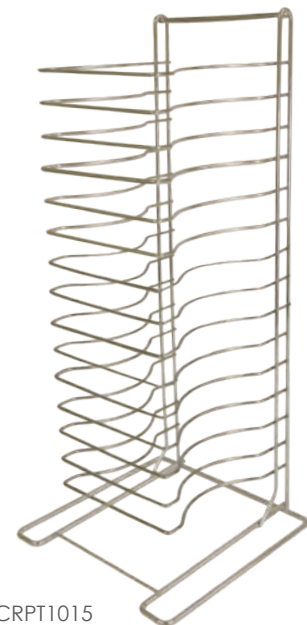

CRPT1015

EGG SLICER

Piano wire cutters finely slice hard-boiled eggs.



ITEM	DESCRIPTION	U/M	WEIGHT GROSS lbs	INNER PACK	MASTER PACK	CU. FT.
ALES-005C	5 1/4" x 3 3/8" x 1" Square Shape	EACH	34.28	12	144	2.03
ALES005R	4 3/4" x 4 1/4" x 1 1/16" Round Shape	EACH	51.80	12	144	2.90



ALES-005C



ALES005R

CHEESE CUTTER

ITEM	DESCRIPTION	U/M	WEIGHT GROSS lbs	INNER PACK	MASTER PACK	CU. FT.
SLKCC005	5 1/4" x 5" x 1/2" with Zinc Alloy Handle	EACH	18.30	1	36	0.42



SLKCC005

MANUAL PASTA MACHINE

Ideal for making fine strands of fresh pasta. Iron body with handle is detachable for cleaning. Medium (6 mm) and fine (2 mm) noodle width roller options included. Comes with table clamp.

ITEM	DESCRIPTION	U/M	WEIGHT GROSS lbs	INNER PACK	MASTER PACK	CU. FT.
GN001	8" x 8" x 5 1/2"	EACH	44.10	1	6	1.63

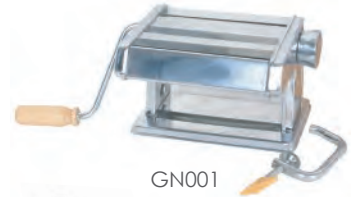

GN001

MIXING PADDLE

A sturdy tool for dough mixing or cooking in large stock pot.

ITEM	DESCRIPTION	U/M	WEIGHT GROSS	INNER PACK	MASTER PACK	CU. FT.
Stainless Steel						
SLMP024	24", 8 7/8" x 4 1/2", 15" Length Handle	EACH	26.46	6	12	1.19
SLMP030	30", 8 7/8" x 4 1/2", 10 7/8" Length Handle	EACH	28.66	6	12	1.27
SLMP036	36", 9" x 4 1/2", 20 7/8" Length Handle	EACH	30.86	6	12	1.36
SLMP042	42", 9" x 4 1/2", 33" Length Handle	EACH	33.07	6	12	1.60
SLMP048	48", 9" x 4 1/2", 39" Length Handle	EACH	35.27	6	12	1.81
SLMP054	54", 9" x 4 1/2", 45" Length Handle	EACH	37.48	6	12	2.05
SLMP060	60", 9" x 4 1/2", 51 1/8" Length Handle	EACH	39.68	6	12	2.26
Wood						
WDTHMP018	18", 7 1/8" x 3 3/8" 10 7/8" Length Handle	EACH	12.13	1	24	0.55
WDTHMP020	20", 7 1/8" x 3 3/8" 12 7/8" Length Handle	EACH	18.70	1	24	0.62
WDTHMP024	24", 7 1/8" x 3 3/8" 16 7/8" Length Handle	EACH	16.98	1	24	0.72
WDTHMP030	30", 7 1/8" x 3 3/8" 22 7/8" Length Handle	EACH	22.05	1	24	0.91
WDTHMP036	36", 7 1/8" x 3 3/8" 28 7/8" Length Handle	EACH	14.33	1	12	0.59
WDTHMP042	42", 7 1/8" x 3 3/8" 34 7/8" Length Handle	EACH	16.53	1	12	0.69
WDTHMP048	48", 7 1/8" x 3 3/8" 40 7/8" Length Handle	EACH	18.34	1	12	0.78
WDTHMP054	54", 7 1/8" x 3 3/8" 46 7/8" Length Handle	EACH	21.56	1	12	0.93
WDTHMP060	60", 7 1/8" x 3 3/8" 52 7/8" Length Handle	EACH	22.44	1	12	1.03



SLMP030



WDTHMP030



CRHH876

HAM HOLDER

Chrome plated wire ham holder.

ITEM	DESCRIPTION	U/M	WEIGHT GROSS lbs	INNER PACK	MASTER PACK	CU. FT.
CRHH876	Ham Holder 8½" x 7¼" x 6"	EACH	39.57	24	24	2.80



CRDB1218

DONUT BASKET

Chrome plated basket holds donuts while cooling.

ITEM	DESCRIPTION	U/M	WEIGHT GROSS lbs	INNER PACK	MASTER PACK	CU. FT.
CRDB1218	12" x 18" x 2"	EACH	42.59	24	24	2.23
CRDB1626	16" x 26" x 2"	EACH	36.58	12	12	2.16



CRDB1626

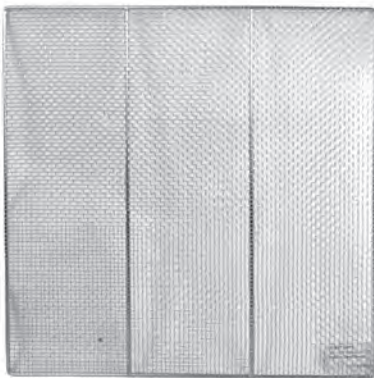

SLRACK0019

SQUARE DONUT SCREEN

Catches icing and glaze while cooling or decorating donuts.



ITEM	DESCRIPTION	U/M	WEIGHT GROSS lbs	INNER PACK	MASTER PACK	CU. FT.
SLRACK0019	19" x 19" x ¼"	EACH	33.07	12	12	0.83
SLRACK0023	23" x 23" x ¼"	EACH	19.07	6	6	0.88



SLRACK1734

ROUND STEAM RACK

Holds food in place while in steamer. Legs allow for room and stacking. Grills allow air to circulate. Nickel plated.



ITEM	DESCRIPTION	U/M	WEIGHT GROSS lbs	INNER PACK	MASTER PACK	CU. FT.
SLRACK1050	10½" Diameter x 1½" Height	EACH	20.28	30	30	0.87
SLRACK1234	12 ¾" Diameter x 1½" Height	EACH	22.05	30	30	1.60
SLRACK1434	14 ¾" Diameter x 1½" Height	EACH	41.89	30	30	2.09
SLRACK1734	17 ¾" Diameter x 1½" Height	EACH	46.99	30	30	3.21

FRYER SCREEN

Easy to clean and durable nickel plated screen.



ITEM	DESCRIPTION	U/M	WEIGHT GROSS lbs	INNER PACK	MASTER PACK	CU. FT.
SLRACK1114	11 ³ / ₈ " x 14 ⁵ / ₈ " Designed to fit Fryer: Frymaster: GF-14SD and MJ-35SD	EACH	46.30	12	48	1.24
SLRACK1313	13 ¹ / ₂ " x 13 ¹ / ₂ " Fits Fryer: Imperial: IFS-40 and American Range: AF-45	EACH	42.99	12	48	1.37

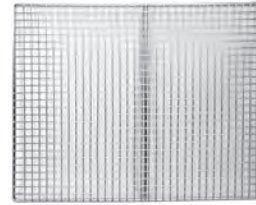

SLRACK1114

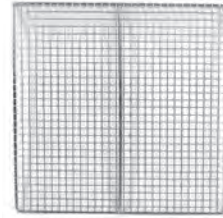

SLRACK1313

ICING/COOLING RACK

Strong chrome-plated wire with built-in feet. Use for decorating and cooling pastries.

ITEM	DESCRIPTION	U/M	WEIGHT GROSS lbs	INNER PACK	MASTER PACK	CU. FT.
SLRACK1624	16" x 23 ³ / ₄ "	EACH	30.01	12	12	1.05
SLRACK1725	17" x 25"	EACH	28.26	12	12	1.64
SLWG1216	12" x 16 ¹ / ₈ "	EACH	64.68	12	48	2.46
SLWG1622	16" x 22"	EACH	40.79	12	24	2.18
SLWG1624	16" x 23 ³ / ₄ "	EACH	57.32	12	24	2.34



SLWG1216



SLWG1622



SLWG1624

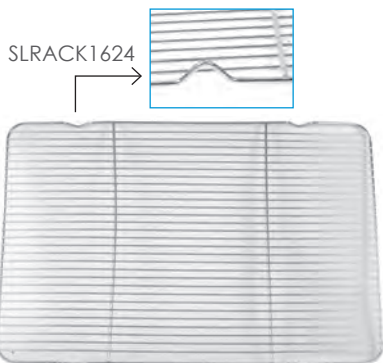

SLRACK1624



SLRACK1725

CHROME PLATED WIRE GRATE

Withstands heat and corrosion. Metal grate with stable feet allows breads, cakes, and cookies to cool.

ITEM	DESCRIPTION	U/M	WEIGHT GROSS lbs	INNER PACK	MASTER PACK	CU. FT.
SLWG001	Third Size 5" x 10"	EACH	17.01	50	50	0.66
SLWG002	Half Size 8" x 10"	EACH	23.15	50	50	0.86
SLWG003	Full Size 18" x 10"	EACH	41.09	50	50	1.89



SLWG002



PLMC008CL



PLMC016CL ~ PLMC128CL



SCSL001 ~ SCSL008



SCSL103, SCSL104



TIM-60



CLRC001

POLYCARBONATE MEASURING CUP

With both U.S. and metric measurements.



ITEM	DESCRIPTION	U/M	WEIGHT GROSS lbs	INNER PACK	MASTER PACK	CU. FT.
PLMC008CL	1 cup/ 0.25L - Polycarbonate Measuring Cup	EACH	6.94	12	48	0.99
PLMC016CL	1 pint/0.5L - Polycarbonate Measuring Cup	EACH	14.31	12	48	2.78
PLMC032CL	1 qt/ 1L - Polycarbonate Measuring Cup	EACH	11.09	12	24	2.59
PLMC064CL	2 qt/ 2L - Polycarbonate Measuring Cup	EACH	9.63	6	12	2.62
PLMC128CL	4 qt/ 4L - Polycarbonate Measuring Cup	EACH	16.69	4	12	5.01
PLMD008CL	1 cup/ 0.25L - Polycarbonate Measuring Cup	EACH	6.94	12	48	0.99
PLMD016CL	1 pint/0.5L - Polycarbonate Measuring Cup	EACH	14.31	12	48	2.78
PLMD032CL	1 qt/ 1L - Polycarbonate Measuring Cup	EACH	11.09	12	24	2.59
PLMD064CL	2 qt/ 2L - Polycarbonate Measuring Cup	EACH	9.63	6	12	2.62
PLMD128CL	4 qt/ 4L - Polycarbonate Measuring Cup	EACH	16.69	4	12	5.01

SCALE

Stainless steel platform with easy to clean enamel finish.

ITEM	DESCRIPTION	U/M	WEIGHT GROSS lbs	INNER PACK	MASTER PACK	CU. FT.
SCSL001	2 lb	EACH	30.80	1	6	3.20
SCSL002	5 lb	EACH	30.80	1	6	3.21
SCSL003	11 lb	EACH	30.80	1	4	3.22
SCSL004	22 lb	EACH	30.80	1	4	3.29
SCSL005	48 lb	EACH	30.80	1	4	3.26
SCSL006	70 lb	EACH	37.40	1	2	3.03
SCSL007	100 lb	EACH	37.40	1	2	3.06
SCSL008	200 lb	EACH	47.30	1	2	4.62

CHINESE CATTIS SCALE

Stainless steel bowl platform.

ITEM	DESCRIPTION	U/M	WEIGHT GROSS lbs	INNER PACK	MASTER PACK	CU. FT.
SCSL103	11 lb	EACH	30.80	1	4	3.24
SCSL104	22 lb	EACH	30.80	1	4	3.17

TIMER

Times up to 60 minutes. Sounds with a long persistent ring.

ITEM	DESCRIPTION	U/M	WEIGHT GROSS lbs	INNER PACK	MASTER PACK	CU. FT.
TIM-60	60 Minute Timer Long Ring	EACH	29.70	12	96	2.62

RICE CLOTH

Great for insulating heat or lining inner pots.

ITEM	DESCRIPTION	U/M	WEIGHT GROSS lbs	INNER PACK	MASTER PACK	CU. FT.
CLRC001	43½" x 43" x ½" Polyester	EACH	53.57	12	144	4.56

POCKET THERMOMETER

Stainless steel case, with pointed stem and bezel. Accurate readings provided on the go. Compact case with pocket clip.



ITEM	DESCRIPTION	U/M	WEIGHT GROSS lbs	INNER PACK	MASTER PACK	CU. FT.
Box						
SLTH160	-40° to 160° F	EACH	28.99	12	432	2.67
SLTH550	50° to 550° F	EACH	28.99	12	432	2.67
Card						
SLTH160C	-40° to 160° F	EACH	16.01	12	192	3.14
SLTH220C	0° to 220° F	EACH	16.01	12	192	3.14
SLTH550C	50° to 550° F	EACH	16.01	12	192	3.14



SLTH220C



SLTH550C

DIAL DEEP FRY/CANDY THERMOMETER

In stainless steel casing.



ITEM	DESCRIPTION	U/M	WEIGHT GROSS lbs	INNER PACK	MASTER PACK	CU. FT.
SLTHD400	100° to 400° F	EACH	16.01	12	96	4.18



SLTHD400

DIAL MEAT THERMOMETER



ITEM	DESCRIPTION	U/M	WEIGHT GROSS lbs	INNER PACK	MASTER PACK	CU. FT.
SLTH200	120° to 200° F	EACH	20.00	12	96	5.51



SLTH200

DIAL THERMOMETER



ITEM	DESCRIPTION	U/M	WEIGHT GROSS lbs	INNER PACK	MASTER PACK	CU. FT.
SLTHD080	Refrigerator/Freezer -20° to 80° F	EACH	22.00	12	144	2.40
SLTHD550	Oven 150° to 550° F	EACH	22.00	12	144	2.40



SLTHD080



SLTHD550



SLTH600



SLTHL080



SLTHL400



WDGB012



SLGB013



SLKR012

LIQUID OVEN THERMOMETER

Stainless steel frame features a cover which doubles as a stand. Mercury-filled glass thermometer, with accuracy of +/- 1 degree.

ITEM	DESCRIPTION	U/M	WEIGHT GROSS lbs	INNER PACK	MASTER PACK	CU. FT.
SLTH600	100° to 600° F	EACH	30.00	12	144	4.12

HORIZONTAL LIQUID SCALE THERMOMETER

Stainless steel casing will not rust in freezer or refrigerator. Dual scale for various readings (Fahrenheit and Celsius). Positions horizontally, either hanging or standing.



ITEM	DESCRIPTION	U/M	WEIGHT GROSS lbs	INNER PACK	MASTER PACK	CU. FT.
SLTHL080	-40° to 80° F	EACH	35.01	12	360	4.13

LIQUID DEEP FRY CANDY THERMOMETER

Heat-resistant handle on stainless steel body. Dual scale readings of Fahrenheit and Celsius, with accuracy of +/- 1 degree.

ITEM	DESCRIPTION	U/M	WEIGHT GROSS lbs	INNER PACK	MASTER PACK	CU. FT.
SLTHL400	100° to 400° F	EACH	44.00	12	96	3.56

MAGNETIC BAR WITH WOODEN BASE

Wooden bar with two magnetic strips for a firm hold.

ITEM	DESCRIPTION	U/M	WEIGHT GROSS lbs	INNER PACK	MASTER PACK	CU. FT.
WDGB012	12" x 2" x 1"	EACH	46.30	1	36	0.70
WDGB018	18" x 2" x 1"	EACH	47.40	1	24	0.68
WDGB024	24" x 2" x 1"	EACH	62.17	1	24	0.89

MAGNETIC BAR WITH HOOKS

Plastic bar with two magnetic strips and optional hanging hooks for a firm hold.

ITEM	DESCRIPTION	U/M	WEIGHT GROSS lbs	INNER PACK	MASTER PACK	CU. FT.
SLGB013	13" x 1½" x 1"	EACH	38.94	1	36	0.73
SLGB018	18" x 1½" x 1"	EACH	56.10	1	36	0.94
SLGB024	24" x 1½" x 1"	EACH	50.71	1	24	0.81

KNIFE RACK

Capacity for up to 5 knives, 2 cleavers and 2 butcher steels. Mountable on walls, counters, or tables.



ITEM	DESCRIPTION	U/M	WEIGHT GROSS lbs	INNER PACK	MASTER PACK	CU. FT.
SLKR012	13" x 12" x 2½"	EACH	24.25	1	12	3.84

NYLON PASTRY BRUSH

Sterilized nylon bristles with contoured handle. Bound by brown plastic ferrule.



ITEM	DESCRIPTION	U/M	WEIGHT GROSS lbs	INNER PACK	MASTER PACK	CU. FT.
WDPB001N	1" Flat - 8¼" x 1" x ½"	EACH	21.03	12	240	1.49
WDPB002N	1½" Flat - 8¾" x 1¾" x ½"	EACH	22.05	12	240	1.75
WDPB003N	2" Flat - 8½" x 2" x ½"	EACH	30.86	12	240	2.31
WDPB004N	3" Flat - 8¾" x 3" x ⅝"	EACH	51.10	12	240	3.77
WDPB005N	4" Flat - 9⅔" x 4" x ⅔"	EACH	63.14	12	240	5.10
WDPB006N	1" Round - 12⅞" x 1" x ½"	EACH	36.38	12	240	3.97

BOAR PASTRY BRUSH

Sterilized and bleached boar bristle brush. Firmly embedded in epoxy to withstand heavy use. Ideal for basting over grills, griddles and ovens, where heat is a factor.



ITEM	DESCRIPTION	U/M	WEIGHT GROSS lbs	INNER PACK	MASTER PACK	CU. FT.
WDPB001	1" Flat - 8¼" x 1" x ½"	EACH	21.03	12	240	1.49
WDPB002	1½" Flat - 8¾" x 1¾" x ½"	EACH	22.05	12	240	1.75
WDPB003	2" Flat - 8½" x 2" x ½"	EACH	30.86	12	240	2.31
WDPB004	3" Flat - 8¾" x 3" x ⅝"	EACH	51.10	12	240	3.77
WDPB005	4" Flat - 9⅔" x 4" x ⅔"	EACH	63.14	12	240	5.10
WDPB006	1" Round - 12⅞" x 1" x ½"	EACH	36.38	12	240	3.97

GAS & ELECTRIC



GAS & ELECTRIC PRODUCTS

STAINLESS STEEL SOUP WARMER

Keep soup at the proper temperature ready to serve. Epoxy coated aluminum body made to match any kitchen decor. Lid attached with hinges for quick serving. Adjustable temperature control. Stainless collar.



SEJ35000C



Voltage: 110V-120V
Max: 185°F
Wattage: 400W



Gift boxed

ITEM	DESCRIPTION	U/M	WEIGHT GROSS lbs	INNER PACK	MASTER PACK	CU. FT.
SEJ35000C	10 qt - Black - 13½" Diameter x 14¾" Height	EACH	12.39	1	1	1.60
SEJ12007-2	Inner Pot for SEJ35000C					



STAINLESS STEEL SOUP/ FOOD WARMER

- Stainless steel case and interior lining
- Thermostatic heat control with 6 settings
- Inset and hinged cover included



SEJ38000C



Voltage: 120V
Max: 185° F
Wattage: 800W



Gift boxed

ITEM	DESCRIPTION	U/M	WEIGHT GROSS lbs	INNER PACK	MASTER PACK	CU. FT.
SEJ38000C	10.5 qt - 12¾" Diameter x 13" Height	EACH	14.26	1	1	1.60
SEJ12007-3	Inner Pot for SEJ38000C					

COUNTERTOP FOOD WARMER

- Heavy duty stainless steel body.
- Thermostatically controlled heating element for longer life.
- Water resistant on/off switch cover.
- Standard 20" x 12" inside well opening accepts most popular steamer pans.
- Includes: 59" power cord & 3-prong grounded plug.



Gift boxed



Voltage: 120V
Max: 194° F
Wattage: 1200W



SEJ81000C



Shown with SLIP003 & SLIP004 Inset Pans and Adaptor plate. Sold separately, page 246 & 247.

ITEM	DESCRIPTION	U/M	WEIGHT GROSS lbs	INNER PACK	MASTER PACK	CU. FT.
SEJ81000C	3.5 qt - 24" x 14 1/2" x 9" Well Capacity - Brushed S/S Finish with Ventilation Slots	EACH	18.00	1	1	2.49

COMMERCIAL ELECTRIC INDUCTION COOKER

Electric Overheating Protection
Touch Control Pad
LED Display Timer: 0-180 minutes
1-10 Power Levels
1-10 Temperature Setting

Temperature Range: 140° F to 464° F
Voltage: 110V-120V. AC / 60Hz
Wattage: 800W



Gift boxed



SEJ45000C

German Schott™ Ceramnic Glass
Stainless Body

ITEM	DESCRIPTION	U/M	WEIGHT GROSS lbs	INNER PACK	MASTER PACK	CU. FT.
SEJ45000C	1800W, 120V, 60HZ, 1800W 16 1/2" x 12 3/8" x 3 7/8"	EACH	28.70	1	2	2.68

SEALING MACHINE

Electrical appliance with adjustable temperature dial for different bag materials and thickness.

Made in Taiwan



ITEM	DESCRIPTION	U/M	WEIGHT GROSS lbs	INNER PACK	MASTER PACK	CU. FT.
IRTISH200	8"	EACH	59.52	1	10	2.50
IRTISH300	11"	EACH	55.12	1	6	2.60
IRTISH400	15 1/4"	EACH	46.30	1	4	2.20



IRTISH200





RER55ASL



RER55ASN

RINNAI GAS COOKER

Prepare rice in this appliance without worries of over cooking. Makes 100 bowls of rice in just 22 minutes (270 servings at 3 oz each). Propane or Natural Gas with piezo pilot ignition. Reduces hazards with Flame Failure Safety Device. Design and safety rated.



ITEM	DESCRIPTION	U/M	WEIGHT GROSS lbs	INNER PACK	MASTER PACK	CU. FT.
RER55ASL	55 cups Propane 23" x 18½" x 17¾"	EACH	45.00	1	1	5.36
RER55ASN	55 cups Natural Gas 23" x 18½" x 17¾"	EACH	45.00	1	1	5.36

Gas Input Rating: 35,000 BTU/h (Natural Gas),
34,000 BTU/h (Propane Gas)
Gas Connection: ½" NPT Female
Safety Device: Flame Failure Safety Device

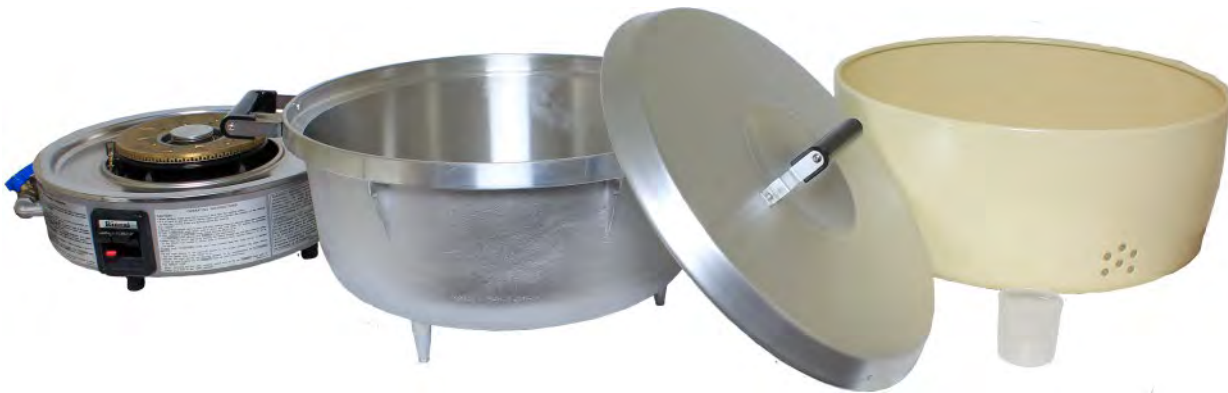

Power switch



Gas connector



Inner pot



ELECTRIC RICE COOKER & WARMER

Makes 30 cups of hassle-free rice. Cooks and keeps warm automatically. Keep rice warm for up to 3 hours. Inner pot is available with a non-stick finish. Cook Time = 28 to 32 minutes for 60 bowls of cooked rice.



ITEM	DESCRIPTION	U/M	WEIGHT GROSS lbs	INNER PACK	MASTER PACK	CU. FT.
SEJ50000	30 cups - 16¼" x 14½" x 14"	EACH	20.00	1	1	2.06
SEJ50000T	30 cups Nonsfick Teflon - 16¼" x 14½" x 14"	EACH	20.00	1	1	2.06

PARTS

SEJB001	Inner Pot for SEJ50000 - 14⅝" x 14½" x 7"	EACH				
SEJB001T	Inner Pot for SEJ50000T - 14⅝" x 14½" x 7"	EACH				
SEJB002	Lid for SEJ5000/ SEJ5000T	EACH				



SEJ50000, SEJ50000T
Voltage: 110V-120V. AC / 60Hz
Wattage: 1780W

ELECTRIC RICE COOKER

Stainless steel exterior with digital pad. Available in 30 cups/60 serving bowls capacity and 33 cups/66 serving bowls capacity. Comes with rice spoon, measuring cup and stick-free silicone pad.



ITEM	DESCRIPTION	U/M	WEIGHT GROSS lbs	INNER PACK	MASTER PACK	CU. FT.
SEJ3201	30 cups - 14⅝" Diameter x 14⅝" height	EACH	22.49	1	1	2.46
SEJ60000	33 cups - 18⅝" x 15" x 13¾"	EACH	24.47	1	1	2.89

PARTS

ITEM	DESCRIPTION	U/M	
1 SEJ64020	Inner Pot for SEJ3201- 14" Diameter x 7⅞" height Non-Stick Aluminum.	EACH	Made in Korea
2 SEJ6012	Inner Pot for SEJ60000 13⅞" Diameter x 8¼" height Non-Stick Teflon Coating Aluminum.	EACH	Made in Taiwan



SEJ3201

Voltage: 110V-120V. AC / 60Hz
Cooking Wattage: 1460W
Warming Wattage: 100W



SEJ60000

Cook Time = 25 min
Voltage: 110V-120V. AC / 60Hz
Cooking Wattage: 1780W
Warming Wattage: 100W
Cooking = 302° F
Warming = 158° F

ELECTRIC RICE WARMER

Mirror finished stainless steel lid and base hinged on wood grain accented body. Keeps rice warm after it is cooked for an additional 12 hours. Serves 30-50 cups. Available in wood grain & mirror polished stainless steel finish.



Made in Taiwan

Voltage: 110V-120V, AC / 60Hz
Wattage: 100W



SEJ18000



SEJ21000



Gift boxed



SEJ20000



SEJ22000



Gift boxed

ITEM	DESCRIPTION	U/M	WEIGHT GROSS lbs	INNER PACK	MASTER PACK	CU. FT.
Woodgrain						
SEJ18000	Wood Grain, 30 cups 15¾" Diameter x 11½" Height	EACH	18.00	1	1	2.48
SEJ21000	Wood Grain, 50 cups 15¾" Diameter x 15" Height	EACH	20.00	1	1	3.00
Stainless Steel						
SEJ22000	Stainless Steel, 50 cups 15¾" Diameter x 15" Height	EACH	20.00	1	1	3.00
SEJ20000	Stainless Steel, 30 cups 15¾" Diameter x 11½" Height	EACH	18.00	1	1	2.48



SEJ004

PARTS

ITEM	DESCRIPTION	U/M
1	SEJ001 Inner Lid for SEJ21000/ SEJ22000	EACH
2	SEJ002 Bushing for SEJ21000/ SEJ22000	EACH
3	SEJ003 Inner Pan Handle	EACH
4	SEJ004 50 Cups Rice Warmer Inner Pot	EACH
5	SEJ004A 30 Cups Rice Warmer Inner Pot	EACH
6	SEJ008 Latch Hook	EACH
7	SEJ009 Radiator Disk	EACH
8	SEJ010 ¾" length Lid Supporting Pin	EACH
9	SEJ011 Upper Lid	EACH
10	SEJ012 Shoulder	EACH
11	SEJ013 1.8 meter length Power Cord	EACH
12	SEJ014 Orange Light "On" While Operated	EACH

Made in Taiwan

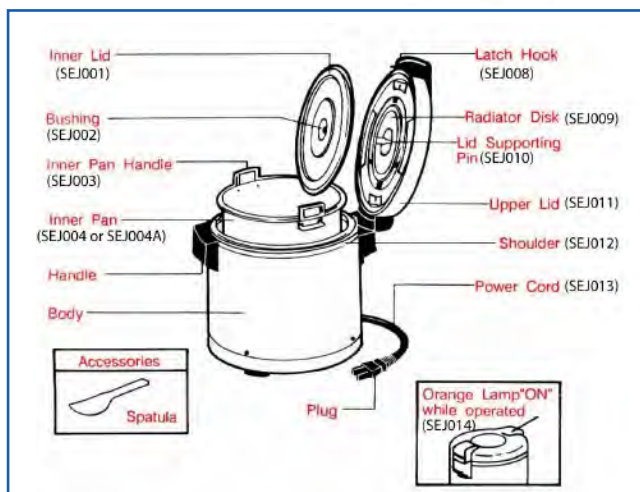

HIGH FREESTANDING DUAL HEAT LAMP

The heat lamp is intended for use in food preparation and storage so that it can heat evenly. The adjustable lamp post allows the user to manipulate the height making it easier to slide the food item underneath the lamp and serve as needed. The heat lamp set is constructed of durable aluminum, includes two shatter-proof 250-watt food safe bulb.



Voltage: 110V-120V, AC / 60Hz
Wattage: 500w
5.42 FT Long Cord



SEJ92001R
250-Watt



SEJ92001C
250-Watt
(Two clear heat bulbs included)



SEJ92000



ITEM	DESCRIPTION	U/M	WEIGHT GROSS lbs	INNER PACK	MASTER PACK	CU. FT.
SEJ92000	23" Heat Lamp - 19 $\frac{3}{4}$ " x 13 $\frac{5}{8}$ " x 23" Adj. Arm 23-30"	SET	5.72	1	1	1.10
SEJ92001C	Clear Bulb for SEJ92000 - 5" Diameter x 6 $\frac{1}{2}$ " length	EACH	7.94	1	24	1.68
SEJ92001R	Red Bulb for SEJ92000 5" Diameter x 6 $\frac{1}{2}$ " length	EACH	7.94	1	24	1.68

SINGLE AND DOUBLE STOVES

Small and compact for limited space. Single stove features easily adjustable heat dial. Double stove features two independently adjustable heat dials. Smooth and easy to clean surface. **Propane only.**

**** No Warranty ****

**** Includes Low Pressure Regulator ****



SLST001
16,500 BTU/H



SLST002
29,700 BTU/H

ITEM	DESCRIPTION	U/M	WEIGHT GROSS lbs	INNER PACK	MASTER PACK	CU. FT.
SLST001	Single Stove, 5kw/hr	EACH	9.02	1	1	0.63
SLST002	Double Stove, 9kw/hr	EACH	16.06	1	1	1.52

Made in Taiwan

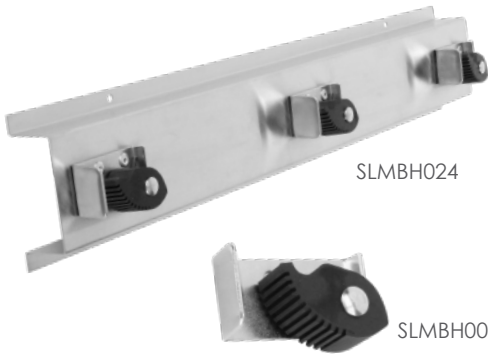

MOP HOLDER: WALL-MOUNT STYLE

ITEM	DESCRIPTION	U/M	WEIGHT GROSS lbs	INNER PACK	MASTER PACK	CU. FT.
SLMBH003	2 5/8" x 2", x 1 1/8" Nickel Plated	EACH	44.40	12	240	1.10
SLMBH024	24" x 4" x 2 5/8" 18/8 Stainless Steel	EACH	17.60	1	8	0.94

18/8 SS STAINLESS STEEL



SLSD040H

Made in Taiwan



SLSD040V

STAINLESS STEEL SOAP DISPENSER

ITEM	DESCRIPTION	U/M	WEIGHT GROSS lbs	INNER PACK	MASTER PACK	CU. FT.
SLSD040H	40 oz Horizontal Rectangular 8 1/4" x 4 7/8" x 5 1/4"	EACH	46.20	1	24	3.86
SLSD040V	40 oz Vertical Rectangular 8 1/4" x 5 1/4" x 4 7/8"	EACH	46.20	1	24	3.86

18/8 SS STAINLESS STEEL

18/8 SS STAINLESS STEEL



PLSD377

PLASTIC SOAP DISPENSER

ITEM	DESCRIPTION	U/M	WEIGHT GROSS lbs	INNER PACK	MASTER PACK	CU. FT.
PLSD377	Anti-Leak Push-Button Soap Dispenser - 32 oz, 8 3/4" x 3 5/8" x 9 1/8"	EACH	29.32	1	24	3.32



SLTD101



SLTD102

TISSUE DISPENSER

ITEM	DESCRIPTION	U/M	WEIGHT GROSS lbs	INNER PACK	MASTER PACK	CU. FT.
SLTD101	Locking Toilet, Single, Chrome Plated 6" x 2 5/8" x 4 1/2" Fits 4" Diameter Toilet Paper Roll	EACH	31.00	1	42	2.15
SLTD102	Locking Toilet, Single, Chrome Plated 12 1/4" x 2 3/4" x 4 3/8" Fits 4" Diameter Toilet Paper Roll	EACH	30.80	1	21	2.15

STAINLESS STEEL TOILET PAPER DISPENSER

ITEM	DESCRIPTION	U/M	WEIGHT GROSS lbs	INNER PACK	MASTER PACK	CU. FT.
SLTD301	Jumbo-Roll Toilet Tissue, 10½" Diameter x 4½"	EACH	39.60	1	12	4.93
SLTD302	Twin Jumbo-Roll Toilet Tissue Dispenser, 20½" x 12½" x 6"	EACH	37.40	1	4	5.00



Key to unlock and open dispenser (included)



SLTD301



SLTD302

PLASTIC TOILET PAPER DISPENSER

ITEM	DESCRIPTION	U/M	WEIGHT GROSS lbs	INNER PACK	MASTER PACK	CU. FT.
PLRPD392	12" x 5¼" x 11¾", Center Core 3¼" Diameter, Hold up to one 9" Diameter	EACH	16.28	1	6	3.58
PLRPD396	19" x 5" x 12¼", Center Core 2¾" Diameter, Hold up to two 9" Diameter	EACH	16.06	1	3	2.99



Key to unlock and open dispenser (included)



PLRPD392

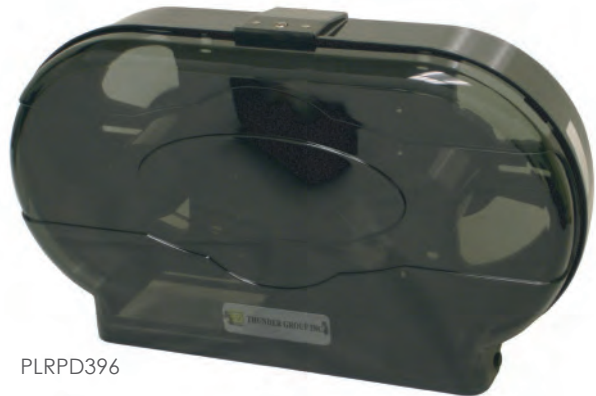

PLRPD396

TOILET SHEET COVER DISPENSER

ITEM	DESCRIPTION	U/M	WEIGHT GROSS lbs	INNER PACK	MASTER PACK	CU. FT.
SLTSCD500	Toilet Seat Cover Dispenser, 500 Sheets 15½" x 11½" x 2" - Fits 15" x 10¾" Seat Cover	EACH	35.20	1	12	3.22



SLTSCD500

TOILET SEAT COVER DISPENSER

Toilet seat cover dispenser's curved contemporary design creates the best impression for your restrooms. Dispenses one cover at a time. Fully enclosed.

ITEM	DESCRIPTION	U/M	WEIGHT GROSS lbs	INNER PACK	MASTER PACK	CU. FT.
CRTSCD3812	Half Fold Toilet Seat Cover Dispenser, Chrome, 16" x 11½" x 3"	EACH	28.60	1	12	3.48
PLTSCD3812	Half Fold Toilet Seat Cover Dispenser, White Plastic, 16" x 11½" x 3"	EACH	16.72	1	20	3.55
Toilet Seat Covers						
PATSC050	Half Fold Paper Toilet Seat Covers 250 Sheet/Pack, 20 Pack/Case, 16½" x 14½"	CASE	24.20	1	1	1.38



PATSC050

PAPER TOWEL DISPENSER

Transparent full-swing replaceable covers provide easy viewing of paper. Covers have key lock.

ITEM	DESCRIPTION	U/M	WEIGHT GROSS lbs	INNER PACK	MASTER PACK	CU. FT.
PLSTD393	Square, 11" x 10½" x 13½" Hold up to 7¼" dia, roll of 8"	EACH	16.28	1	3	3.52
PLPTD394	Center-Pull 9½" x 8½" x 13½" Hold up to 8" dia, roll of 9½"	EACH	23.98	1	6	6.13
PLFTD395	Multi-Fold 11½" x 4¼" x 14¼" Hold up to 10¼" width	EACH	36.08	1	10	6.96



PLSTD393



PLPTD394



PLFTD395



PLSTD393 Open



PLSTD393 Back

STAINLESS STEEL HOOD FILTER

Easy to clean with detergent and water, also dishwasher safe.



ITEM	DESCRIPTION	U/M	WEIGHT GROSS lbs	INNER PACK	MASTER PACK	CU. FT.
SLHF1620	16" X 20" x 1½"	EACH	23.34	1	6	2.57
SLHF1625	16" X 25" x 1½"	EACH	29.07	1	6	3.19
SLHF2016	20" X 16" x 1½"	EACH	23.56	1	6	2.57
SLHF2020	20" X 20" x 1½"	EACH	27.97	1	6	3.12
SLHF2025	20" X 25" x 1½"	EACH	33.69	1	6	3.92



DUST PAN & BROOM

Plastic general-purpose dust pan, with flat surface and easy-grip handle. Made to catch dirt residue. Brooms are available in natural coconut and polypropylene bristle.



ITEM	DESCRIPTION	U/M	WEIGHT GROSS lbs	INNER PACK	MASTER PACK	CU. FT.
PLDP002	12" x 13" x 28¾" Dust Pan	DOZEN	11.46	1	1	1.56
PLDP003	12" x 10½" x 42" Broom Set	DOZEN	21.61	1	1	2.02
PLSP001	13½" x 7¾" x 46½" Broom	EACH	79.37	1	100	12.00
PLDP345	13" x 12" x 36¾" Lobby Dust Pan with Windbreak Cover	EACH	23.32	1	10	2.34

Made in Taiwan

Made in Taiwan

Made in Taiwan



PLGL001

PLGL004GR

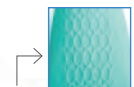

GLOVES

Washable and safe to reuse.

Made in Taiwan

ITEM	DESCRIPTION	U/M	WEIGHT GROSS lbs	INNER PACK	MASTER PACK	CU. FT.
Rubber						
PLGL001	8½" x 13", Regular	DOZEN	92.59	1	30	3.90
PLGL002	8½" x 16", Long	DOZEN	90.39	1	20	3.33
PLGL003	9½" x 16", XL	DOZEN	77.16	1	12	3.50
PLGL004	9" x 16"	DOZEN	55.44	1	10	2.47
Latex						
PLGL004GR	12" x 3¾", Green	PAIR	18.50	12	144	1.02



PLWB361W

PLWB361 SET

PLWB361B

MOP HANDLE & MOP BUCKETS W/ WRINGER

Predominantly plastic non-marking caster for reduced touch-up cleaning. Smooth easy-to-clean surfaces.

ITEM	DESCRIPTION	U/M	WEIGHT GROSS lbs	INNER PACK	MASTER PACK	CU. FT.
PLWB361	36 qt Bucket with Wringer Set, Yellow 19½" x 16" x 24" - Handle 17"	SET	14.39	1	1	2.66
PLWB361B	Bucket 9½" x 16" x 10½" - w/o Wheel. 4" Wheel	EACH	25.95	1	4	4.60
PLWB361W	Wringer 11" x 9¾" x 14½"	EACH	21.61	1	2	2.68



PLFL330

PLFCS330
PLFCS332

POP-UP SAFETY CONE

No assembly required.

ITEM	DESCRIPTION	U/M	WEIGHT GROSS lbs	INNER PACK	MASTER PACK	CU. FT.
PLFCS330	19 ½" w/ Storage Tube	EACH	57.20	1	48	4.49
PLFCS332	31" w/ Storage Tube	EACH	48.28	1	24	4.53
PLFL330	Flashing Light	EACH	7.27	1	48	0.80

** Batteries for PLFL330 Flashing Light are not included.**



PLWFC024

PLWFC027

CAUTION SIGN

Two-sided signs.

ITEM	DESCRIPTION	U/M	WEIGHT GROSS lbs	INNER PACK	MASTER PACK	CU. FT.
PLWFC024	Fold-Up 24" x 12"	EACH	17.64	1	10	1.99
PLWFC027	Cone 10¾" x 10¾" x 27"	EACH	28.97	1	10	3.40



RYTP351A

PLUNGER

Plastic material is easy to clean.

ITEM	DESCRIPTION	U/M	WEIGHT GROSS lbs	INNER PACK	MASTER PACK	CU. FT.
RYTP351A	21" Long Wood Handle, 5¾" Diameter Black Rubber	EACH	47.30	1	48	2.34



TRASH CAN

Lids and dollies are sold separately.

ITEM	DESCRIPTION	U/M	WEIGHT GROSS lbs	INNER PACK	MASTER PACK	CU. FT.
Trash Can - Comparable to Slim Jim Trash Can						
PLTC023G	23 Gallon, Gray - 20" x 11¼" x 29¾"	EACH	7.46	1	1	0.74
PLTC023GL	Lid for PLTC023G, Gray - 20" 11¼" x 6¼"	EACH	16.64	1	10	3.03
PLTC023B	23 Gallon, Brown - 20" x 11¼" x 29¾"	EACH	7.46	1	1	0.74
PLTC023BL	Lid for PLTC023B, Brown - 20" 11¼" x 6¼"	EACH	16.64	1	10	3.03
PLTC023K	23 Gallon, Black - 20" x 11¼" x 29¾"	EACH	7.46	1	1	0.74
PLTC023KL	Lid for PLTC023K, Black - 20" 11¼" x 6¼"	EACH	16.64	1	10	3.03
PLTC023	Dolly for PLTC023 Series Trash Can - 24¾" x 15¾" x 8¼" Inner Fitting Size: 17¼" x 8⅞" x 3¾"	EACH	29.98	1	6	6.36
PLWT007K	7 Gallon, Black 14" x 11.5" x 15"	EACH	24.31	1	6	3.06
Round Trash Can						
PLTC010W	10 Gallon, Plastic, White - 15½" Diameter x 16⅞" Height	EACH	2.31	1	1	0.70
PLTC010WL	Lid For PLTC010W, White - 15⅞" Diameter x 1¼" Height	EACH	6.81	1	10	1.78
PLTC020G	20 Gallon, Plastic, Gray - 19⅞" Diameter x 22⅞" Height	EACH	5.06	1	1	1.34
PLTC020GL	Lid For PLTC020G, Gray - 19½" Diameter x 1¼" Height	EACH	10.64	1	10	2.06
PLTC020W	20 Gallon, Plastic, White - 19⅞" Diameter x 22⅞" Height	EACH	5.06	1	1	1.34
PLTC020WL	Lid For PLTC020W, White - 19½" Diameter x 1¼" Height	EACH	10.64	1	10	2.06
PLTC032G	32 Gallon, Gray - 22⅞" Diameter x 27⅞" Height	EACH	22.80	1	1	4.10
PLTC032GL	Lid for PLTC032G, Gray - 19½" Diameter x 1¼" Height	EACH	22.80	1	10	3.56
PLTC032GH	Center Opened Lid For PLTC032G, Plastic, Gray - 22" Diameter x 1¼" Height. Center Opening 8¼" Diameter x ¾" Height	EACH	19.84	0	10	3.56
PLTC044G	44 Gallon, Gray - 23⅞" Diameter x 31¼" Height	EACH	28.00	1	1	3.57
PLTC044GL	Lid for PLTC044G, Gray - 24⅞" Diameter x 1½" Height	EACH	28.00	1	10	4.06
PLTC044GH	Center Opened Lid For PLTC044G, Plastic, Gray - 24⅞" Diameter x 1½" Height. Center Opening 9¼" Diameter x ¾" Height	EACH	24.25	0	10	4.06
PLTC005	18" Diameter x 6" Black 5 Caster Trash Can Dolly - 1¼" Stem	EACH	36.93	1	6	4.24
Recycling Trash Can						
PLTC023R	Trash Can, 23 Gallon, Recycle Mark, Plastic - 20" x 11¼" x 29¾"	EACH	7.46	1	1	0.74
PLTC023RC	Bottles/Cans Recycle Lid, For PLTC023R - 20⅞" x 11⅞" x 3"	EACH	17.64	0	20	2.58
PLTC023RL	Lid For PLTC023R - 20⅞" x 11⅞" x 6¾"	EACH	16.64	1	10	3.03
PLTC023RP	Paper Recycle Lid For PLTC023R - 20⅞" x 11⅞" x 3"	EACH	17.64	0	20	2.58
PLWT007R	7 Gallon, Recycle Mark, Plastic - 14" x 11.5" x 15"	EACH	24.31	1	6	3.06

BUS BOX

Heavy-duty and easy to clean with durable handles for quick kitchen transporting. Freezer-safe.



ITEM	DESCRIPTION	U/M	WEIGHT GROSS lbs	INNER PACK	MASTER PACK	CU. FT.
PLBT002W	White 14½" x 12½" x 5½"	EACH	0.81	1	1	0.14
PLBT005B	Black, 20½" x 15½" x 5"	EACH	1.50	1	1	0.20
PLBT005G	Gray, 20½" x 15½" x 5"	EACH	1.50	1	1	0.20
PLBT005W	White, 20½" x 15½" x 5" Freezer Safe	EACH	1.50	1	1	0.20
PLBT007B	Black, 20½" x 15½" x 7"	EACH	1.95	1	1	0.30
PLBT007G	Gray, 20½" x 15½" x 7"	EACH	1.95	1	1	0.30
PLBT007W	White, 20½" x 15½" x 7" Freezer Safe	EACH	1.95	1	1	0.30

BUS BOXES COVER



ITEM	DESCRIPTION	U/M	WEIGHT GROSS lbs	INNER PACK	MASTER PACK	CU. FT.
PLBTCC001B	Black - Fits PLBT005B/ PLBT007B 21½" x 16" x 1"	EACH	63.03	1	48	4.99
PLBTCC001G	Gray - Fits PLBT005G/ PLBT007G 21½" x 16" x 1"	EACH	63.03	1	48	4.99
PLBTCC001W	White - Fits PLBT005W/ PLBT007W 21½" x 16" x 1" Freezer Safe	EACH	63.03	1	48	4.99
PLBTCC002W	White -Fits PLBT002W 14⅞" x 12½" x 5¼"	EACH	27.58	1	48	1.87

PERFORATED BUS BOXES



ITEM	DESCRIPTION	U/M	WEIGHT GROSS lbs	INNER PACK	MASTER PACK	CU. FT.
PLBT505BPF	Black, 20½" x 15½" x 5"	EACH	2.05	1	1	0.20
PLBT505GPF	Gray, 20½" x 15½" x 5"	EACH	2.05	1	1	0.20
PLBT505WPF	White, 20½" x 15½" x 5"	EACH	2.05	1	1	0.20

BUS CARTS, BINS, & ACCESSORIES

Clean up tables, transport bins and other supplies efficiently. Carts come with 2 locking casters & 2 regular casters.



ITEM	DESCRIPTION	U/M	WEIGHT GROSS lbs	INNER PACK	MASTER PACK	CU. FT.
3-Tier Bus Cart						
PLBC3316B	3-Tier Bus Cart - Black 33½" x 16½" x 37"	EACH	24.25	1	1	2.79
PLBC3316G	3-Tier Bus Cart - Gray 33½" x 16½" x 37"	EACH	24.25	1	1	2.79
PLBC4019B	3-Tier Bus Cart - Black 40½" x 19¾" x 37½"	EACH	34.79	1	1	4.40
PLBC4019G	3-Tier Bus Cart - Gray 40½" x 19¾" x 37½"	EACH	34.79	1	1	4.40
Accessories						
PLBC0012B	Silverware Bin 13" x 9¼" x 7"	EACH	11.00	1	6	2.02
PLBC0013B	Refuse Bin 13" x 9¼" x 22"	EACH	27.06	1	6	4.20
PLCB4140	4" Wheel - 4" Diameter x 6½" Height w/ 2½" width on wheel For Bus Carts PLBC3316 / PLBC4019	EACH	25.24	4	24	0.89
PLCB4140B	4" Wheel with Brake - 4" Diameter x 6½" Height w/ 2½" width on wheel For Bus Carts PLBC3316 / PLBC4019	EACH	29.48	4	24	0.89

FLOOR DRAIN STRAINER

Drain out water to keep floor dry and safe. Catch debris to prevent drain line blockage.



ITEM	DESCRIPTION	U/M	WEIGHT GROSS lbs	INNER PACK	MASTER PACK	CU. FT.
Plastic						
PLFDS285	ABS 8½" x 8½" x 2¼"	EACH	23.15	12	48	2.66
Stainless Steel						
SLFDS310	0.8 mm, 10" x 10" x 3"	EACH	33.07	6	24	0.64
SLFDS385	0.8 mm, 8½" x 8½" x 3"	EACH	41.89	12	24	3.20
SLFDS510	0.8 mm, 10" x 10" x 5"	EACH	48.50	6	24	2.32





PLFCCB001



PLFCCB001B



CUTLERY BOX

ITEM	DESCRIPTION	U/M	WEIGHT GROSS lbs	INNER PACK	MASTER PACK	CU. FT.
PLFCCB001	4 Compartment, Gray 22½" x 13" x 4" Inside: 4⅞" x 10⅞" x 4"	EACH	2.03	1	1	0.37
PLFCCB001B	4 Compartment, Black 22½" x 13" x 4" Inside: 4⅞" x 10⅞" x 4"	EACH	2.03	1	1	0.37
SLSCB04	4 Compartment 16⅞" x 10" x 3⅞" Inside: 4⅞" x 9⅞" x 3⅞"	EACH	28.66	1	8	3.55



SLSCB04



BUS BOX

Outer lips are used for easy-to-carry. Random colors; red and blue.



PLDB003 ~ PLDB007

ITEM	DESCRIPTION	U/M	WEIGHT GROSS lbs	INNER PACK	MASTER PACK	CU. FT.
PLDB003	14⅞" x 11⅞" x 3⅞"	EACH	15.43	1	20	1.38
PLDB004	15¼" x 12¼" x 3¾"	EACH	19.84	1	20	1.65
PLDB005	17⅝" x 13⅞" x 4⅞"	EACH	28.66	1	20	2.65
PLDB006	19½" x 15½" x 5⅞"	EACH	38.58	1	20	3.48
PLDB007	21⅜" x 16⅞" x 6"	EACH	56.22	1	20	6.35

DUNNAGE RACK

Constructed of heavy duty welded aluminum square tubes. Available in 3 sizes.

* Shipped Freight Only - No UPS *



ALUMINUM



ALDN2036~
ALDN2036E



ALDN2048~
ALDN2048E



ALDN2060 ~ ALDN2060E

ITEM	DESCRIPTION	U/M	WEIGHT GROSS lbs	INNER PACK	MASTER PACK	CU. FT.
Height 12"						
ALDN2036	20" x 36" x 12" Up to 1500 lb Load Capacity	EACH	45.25	1	6	9.78
ALDN2048	20" x 48" x 12" Up to 1800 lb Load Capacity	EACH	51.46	1	6	12.53
ALDN2060	20" x 60" x 12" Up to 2100 lb Load Capacity	EACH	65.72	1	6	15.46
Height 8"						
ALDN2036E	20" x 36" x 8" Up to 1200 lb Load Capacity	EACH	40.80	1	6	7.94
ALDN2048E	20" x 48" x 8" Up to 1500 lb Load Capacity	EACH	49.80	1	6	10.21
ALDN2060E	20" x 60" x 8" Up to 1800 lb Load Capacity	EACH	58.80	1	6	12.60

SINK STRAINER

Rust resistant stainless steel sink strainer. Extra fine mesh lining for eliminating unwanted residue in drains. Light weight and easy to rinse.



ITEM	DESCRIPTION	U/M	WEIGHT GROSS lbs	INNER PACK	MASTER PACK	CU. FT.
Narrow Rim						
SLSN001	Sink Strainer - Large	EACH	50.26	12	720	3.96
SLSN002	Sink Strainer - Medium	EACH	30.86	12	720	2.13
SLSN003	Sink Strainer - Small	EACH	18.70	12	720	0.61
Wide Rim						
SLSN001W	Sink Strainer - Large (Wide Rim)	EACH	24.25	12	288	2.02
SLSN002W	Sink Strainer - Medium (Wide Rim)	EACH	15.43	12	288	0.93
SLSTR30	3" Sink Strainer with 2½" Stopper	EACH	26.46	12	144	1.93
SLSN335	3½" Sink Strainer	EACH	59.52	72	576	0.92

RUBBER SCRAP BLOCK

Scrape off food residues and prevent water from draining into trash opening on the dish washing counter. Fits standard 5¾" receptacle openings.

ITEM	DESCRIPTION	U/M	WEIGHT GROSS lbs	INNER PACK	MASTER PACK	CU. FT.
PLRSB064	6½" Diameter x 4" Deep	EACH	46.30	1	12	1.44



SCRUBBER PAD & BRISTLE

Scrubbers available in nylon scouring pad pot scrubber. Ideal for cleaning pots, pans, sink basins, and all scouring jobs. Helpful with dishwashing.



ITEM	DESCRIPTION	U/M	WEIGHT GROSS lbs	INNER PACK	MASTER PACK	CU. FT.
SLSC001	Scrubber Ball, 50g	DOZEN	18.08	1	12	1.58
SLSC002	Scrubber Pad, 42g	DOZEN	15.20	1	12	2.52
SLSC003	Scrubber Ball, 105g	DOZEN	34.61	1	12	3.38
PLNP001	Nylon Pad 100pcs/case 27g, 9½" x 6" x ¼"	CASE	7.22	1	1	1.25
PLNP002	Nylon Blend, 6 piece/pack	PACK	25.35	0	60	4.06
PLSB703	7" x 3½" x 4" Heavy Duty Handy Steel Bristle	EACH	28.82	1	72	2.93



KITCHEN UTENSILS



ONE-PIECE PLASTIC HANDLE ICE CREAM DISHER

One-piece plastic handle improves durability and prevents handle from coming apart. Bowl and components are made with 18/8 stainless steel to prevent corrosion. Color coded handles for accurate portions. Easy to clean.



SLDS206P SLDS208P SLDS210P SLDS212P SLDS216P SLDS220P SLDS224P SLDS230P SLDS240P

ITEM	DESCRIPTION	No.	U/M	WEIGHT GROSS lbs	INNER PACK	MASTER PACK	CU. FT.
SLDS206P	5½ oz White - 9¾" x 3¼" x 1½"	#6	EACH	15.39	1	36	1.33
SLDS208P	4 oz Gray - 9¾" x 3⅜" x 1½"	#8	EACH	14.75	1	36	1.33
SLDS210P	3¼ oz Ivory - 9¾" x 3⅜" x 1½"	#10	EACH	14.27	1	36	1.33
SLDS212P	2¾ oz Green - 9¼" x 3⅜" x 1½"	#12	EACH	13.64	1	36	1.33
SLDS216P	2 oz Blue - 9" x 3" x 1⅜"	#16	EACH	13.16	1	36	1.33
SLDS220P	1½ oz Yellow - 8⅞" x 3" x 1⅜"	#20	EACH	12.85	1	36	1.28
SLDS224P	1⅓ oz Red - 8⅞" x 3" x 1⅜"	#24	EACH	12.37	1	36	1.28
SLDS230P	1 oz Black - 8½" x 3" x 1⅝"	#30	EACH	12.21	1	36	1.28
SLDS240P	¾ oz Orchid - 8¼" x 3" x 1¼"	#40	EACH	11.90	1	36	1.28



ONE-PIECE PLASTIC HANDLE ICE CREAM DISHER (EASY GRIP)

One-piece plastic handle improves durability and prevents handle from coming apart. Color coded handles for size and accurate portions. Acetal Copolymer plastic material makes the handle in low moisture absorption, dimensionally stable for tight tolerance. Easy to clean.



SLDS206G SLDS208G SLDS210G SLDS212G SLDS216G SLDS220G SLDS224G SLDS230G SLDS240G

ITEM	DESCRIPTION	No.	U/M	WEIGHT GROSS lbs	INNER PACK	MASTER PACK	CU. FT.
SLDS206G	5½ oz White - 9¾" x 3" x 1⅝"	#6	EACH	16.16	1	36	1.28
SLDS208G	4 oz Grey - 9¼" x 3" x 1½"	#8	EACH	15.52	1	36	1.28
SLDS210G	3¼ oz Ivory - 9" x 3" x 1½"	#10	EACH	15.05	1	36	1.28
SLDS212G	2¾ oz Green - 8⅞" x 3" x 1½"	#12	EACH	14.41	1	36	1.28
SLDS216G	2 oz Blue - 8⅞" x 3" x 1½"	#16	EACH	13.94	1	36	1.28
SLDS220G	1½ oz Yellow - 8½" x 2¾" x 1½"	#20	EACH	13.62	1	36	1.23
SLDS224G	1⅓ oz Red - 8¼" x 2¾" x 1½"	#24	EACH	13.14	1	36	1.23
SLDS230G	1 oz Black - 8½" x 2¾" x 1⅜"	#30	EACH	12.98	1	36	1.23
SLDS240G	¾ oz Orchid - 7⅞" x 2¼" x 1⅝"	#40	EACH	12.66	1	36	1.23



ICE CREAM DISHER



SLDS006 SLDS008 SLDS010 SLDS012 SLDS016 SLDS020 SLDS024 SLDS030 SLDS040

ITEM	DESCRIPTION	No.	U/M	WEIGHT GROSS lbs	INNER PACK	MASTER PACK	CU. FT.
A	SLDS006 5½ oz, White - 9" x 3½" x 1½"	#6	EACH	14.33	1	36	1.48
B	SLDS008 4 oz, Grey - 9" x 3" x 1½"	#8	EACH	13.67	1	36	1.48
C	SLDS010 3¼ oz, Ivory - 8¾" x 3" x 1½"	#10	EACH	13.23	1	36	1.48
D	SLDS012 2½ oz, Green - 8¾" x 3¼" x 1½"	#12	EACH	12.12	1	36	1.20
E	SLDS016 2 oz, Blue - 8¾" x 3½" x 1¾"	#16	EACH	11.02	1	36	1.10
F	SLDS020 1½ oz, Yellow - 8½" x 3¼" x 1¼"	#20	EACH	12.13	1	36	1.10
G	SLDS024 1½ oz, Red - 8¼" x 3" x 1¼"	#24	EACH	11.68	1	36	1.10
H	SLDS030 1 oz, Black - 8¼" x 2¾" x 1½"	#30	EACH	12.00	1	36	1.10
I	SLDS040 ¾ oz, Orchid - 7¾" x 2½" x 1½"	#40	EACH	11.00	1	36	1.10

Color Coded

18/8 SS STAINLESS STEEL



SLDS006L SLDS008L SLDS010L SLDS012L SLDS016L SLDS020L SLDS024L SLDS030L SLDS040L

ITEM	DESCRIPTION	No.	U/M	WEIGHT GROSS lbs	INNER PACK	MASTER PACK	CU. FT.
Ergonomic Handle (Lever Dishers)							
J	SLDS006L 5½ oz, White - 10½" x 3¼" x 1¾"	#6	EACH	14.77	1	36	1.55
K	SLDS008L 4 oz, Gray - 10¼" x 3¼" x 1¾"	#8	EACH	14.33	1	36	1.55
L	SLDS010L 3¼ oz, Ivory - 10¼" x 3¼" x 1¾"	#10	EACH	15.50	1	36	1.55
M	SLDS012L 2½ oz, Green - 10" x 3¼" x 1¼"	#12	EACH	13.67	1	36	1.26
N	SLDS016L 2 oz, Blue - 9¾" x 2¼" x 1½"	#16	EACH	13.23	1	36	1.30
O	SLDS020L 1½ oz, Yellow - 9½" x 3" x 1¼"	#20	EACH	13.00	1	36	1.30
P	SLDS024L 1½ oz, Red - 9½" x 3" x 1¾"	#24	EACH	12.79	1	36	1.30
Q	SLDS030L 1 oz, Black - 9¼" x 2¾" x 1½"	#30	EACH	12.57	1	36	1.30
R	SLDS040L ¾ oz, Orchid - 9¼" x 2¾" x 1½"	#40	EACH	12.35	1	36	1.29

Color Coded

18/8 SS STAINLESS STEEL



ONE-PIECE PORTION CONTROLLER, 1 mm

Reliable stainless steel portion controller with plastic handle. Easy grip handle for precise measure of ingredients.



ITEM	DESCRIPTION	U/M	WEIGHT GROSS lbs	INNER PACK	MASTER PACK	CU. FT.
Solid						
A	SLLD002A 2 oz Red, 13" x 2 $\frac{5}{8}$ " x 1 $\frac{3}{4}$ "	EACH	27.60	12	120	2.05
B	SLLD003A 3 oz Ivory, 12 $\frac{5}{8}$ " x 2 $\frac{7}{8}$ " x 1 $\frac{3}{4}$ "	EACH	30.51	12	120	2.24
C	SLLD004A 4 oz Green, 13 $\frac{3}{4}$ " x 3 $\frac{1}{4}$ " x 1 $\frac{1}{2}$ "	EACH	34.65	12	120	2.71
D	SLLD006A 6 oz Black, 14 $\frac{3}{4}$ " x 4" x 1 $\frac{3}{4}$ "	EACH	38.72	12	120	3.55
E	SLLD008A 8 oz Blue, 14 $\frac{1}{2}$ " x 4 $\frac{1}{8}$ " x 2"	EACH	49.09	12	120	3.62
Perforated						
F	SLLD102PA 2 oz Red, 13" x 2 $\frac{5}{8}$ " x 1 $\frac{3}{4}$ ", Hole: $\frac{3}{16}$ "	EACH	27.60	12	120	2.05
G	SLLD103PA 3 oz Ivory, 12 $\frac{5}{8}$ " x 2 $\frac{7}{8}$ " x 1 $\frac{5}{8}$ ", Hole: $\frac{3}{16}$ "	EACH	30.51	12	120	2.24
H	SLLD104PA 4 oz Green, 13 $\frac{7}{8}$ " x 3 $\frac{1}{4}$ " x 1 $\frac{1}{2}$ ", Hole: $\frac{3}{16}$ "	EACH	34.65	12	120	2.71
I	SLLD106PA 6 oz Black, 14 $\frac{1}{4}$ " x 4" x 2", Hole: $\frac{3}{16}$ "	EACH	38.72	12	120	3.55
J	SLLD108PA 8 oz Blue, 15 $\frac{3}{8}$ " x 4 $\frac{5}{16}$ " x 1 $\frac{1}{4}$ ", Hole: $\frac{3}{16}$ "	EACH	49.09	12	120	3.62

TWO-PIECE PORTION CONTROLLER, 1 mm

Reliable stainless steel portion controller with plastic handle. Easy grip handle for precise measure of ingredients.



ITEM	DESCRIPTION	U/M	WEIGHT GROSS lbs	INNER PACK	MASTER PACK	CU. FT.
Solid						
K	SLLD002 2 oz Blue, 13" x 2 $\frac{5}{8}$ " x 1 $\frac{3}{4}$ "	EACH	27.12	12	120	2.05
L	SLLD003 3 oz Ivory, 12 $\frac{5}{8}$ " x 2 $\frac{7}{8}$ " x 1 $\frac{3}{4}$ "	EACH	27.56	12	120	2.24
M	SLLD004 4 oz Gray, 13 $\frac{3}{4}$ " x 3 $\frac{1}{4}$ " x 1 $\frac{1}{2}$ "	EACH	25.35	12	120	2.71
N	SLLD006 6 oz Green, 14 $\frac{3}{4}$ " x 4" x 1 $\frac{3}{4}$ "	EACH	37.49	12	120	3.55
O	SLLD008 8 oz Orange, 14 $\frac{1}{2}$ " x 4 $\frac{1}{8}$ " x 2"	EACH	39.25	12	120	3.62
Perforated						
P	SLLD102P 2 oz Blue, 13" x 2 $\frac{5}{8}$ " x 1 $\frac{3}{4}$ ", Hole: $\frac{3}{16}$ "	EACH	27.12	12	120	2.05
Q	SLLD103P 3 oz Ivory, 12 $\frac{5}{8}$ " x 2 $\frac{7}{8}$ " x 1 $\frac{5}{8}$ ", Hole: $\frac{3}{16}$ "	EACH	27.56	12	120	2.24
R	SLLD104P 4 oz Gray, 13 $\frac{7}{8}$ " x 3 $\frac{1}{4}$ " x 1 $\frac{1}{2}$ ", Hole: $\frac{3}{16}$ "	EACH	25.35	12	120	2.71
S	SLLD106P 6 oz Green, 14 $\frac{1}{4}$ " x 4" x 2", Hole: $\frac{3}{16}$ "	EACH	37.49	12	120	3.55
T	SLLD108P 8 oz Orange, 15 $\frac{3}{8}$ " x 4 $\frac{5}{16}$ " x 1 $\frac{1}{4}$ ", Hole: $\frac{3}{16}$ "	EACH	39.25	12	120	3.62

AMBIDEXTROUS SCOOP

Ambidextrous twin grip handle. Tension free, spring release for easy handling.



ITEM	DESCRIPTION	No.	U/M	WEIGHT GROSS lbs	INNER PACK	MASTER PACK	CU. FT.
SLDA008	4 oz, 2 3/4" Bowl Diameter 9 3/4" x 2 7/8" x 1 1/2"	#8	EACH	45.76	1	120	3.42
SLDA010	3 3/4 oz, 2 5/8" Bowl Diameter 9 3/8" x 2 3/4" x 1 3/4"	#10	EACH	48.50	1	120	3.42
SLDA012	3 1/4 oz, 2 1/2" Bowl Diameter 9 3/8" x 2 3/4" x 1 1/2"	#12	EACH	48.50	1	120	3.42
SLDA016	2 3/4 oz, 2 1/4" Bowl Diameter 9" x 2 3/8" x 1 3/8"	#16	EACH	38.58	1	120	2.34
SLDA020	2 1/2 oz, 2 1/8" Bowl Diameter 8 7/8" x 2 3/8" x 1 3/8"	#20	EACH	41.89	1	120	2.28
SLDA024	1 3/4 oz, 2" Bowl Diameter 8 3/4" x 2 3/8" x 1 1/4"	#24	EACH	40.79	1	120	2.28
SLDA030	1 1/4 oz, 1 5/8" Bowl Diameter 8 3/4" x 2 3/8" x 1 1/4"	#30	EACH	38.58	1	120	2.28
SLDA040	7/8 oz, 1 3/4" Bowl Diameter 8 5/8" x 2 1/2" x 1 1/8"	#40	EACH	38.58	1	120	2.28
SLDA050	5/8 oz, 1 1/4" Bowl Diameter 8 1/2" x 2 3/8" x 1 3/8"	#50	EACH	37.48	1	120	2.14
SLDA060	3/4 oz, 1 1/2" Bowl Diameter 8 1/4" x 2 3/8" x 1 1/4"	#60	EACH	36.38	1	120	2.14
SLDA070	1/2 oz, 1 1/8" Bowl Diameter 8 1/4" x 2 3/8" x 1 1/4"	#70	EACH	36.38	1	120	2.14
SLDA100	3/8 oz, 1 1/4" Bowl Diameter 8" x 2 1/2" x 2 1/4"	#100	EACH	32.12	1	120	2.14
SLDAOVAL	1 1/2 oz, 1 3/8" x 2 1/2" Bowl Diameter 9 1/8" x 2 3/8" x 1 1/8"		EACH	39.60	1	120	2.51



SLDAOVAL



CAST ALUMINUM DIPPER

These sturdy dippers are ideal for all-purpose portion servings.



ITEM	DESCRIPTION	U/M	WEIGHT GROSS lbs	INNER PACK	MASTER PACK	CU. FT.
Aluminum						
SLTHDP012	3 oz, Yellow - 7 1/8" x 2" x 1 5/8"	EACH	25.00	12	60	1.20
SLTHDP016	2 1/2 oz, Green - 7 1/8" x 1 3/4" x 1 1/2"	EACH	21.00	12	60	1.20
SLTHDP020	2 oz, Brown - 7 1/8" x 1 5/8" x 1 1/4"	EACH	20.00	12	60	1.20
SLTHDP024	1 1/2 oz, Red - 7 1/8" x 1 1/2" x 1 1/4"	EACH	19.00	12	60	1.20
Non-Stick (Teflon)						
SLTHDP112	3 oz, Yellow - 7 1/8" x 2" x 1 5/8"	EACH	25.00	12	60	1.20
SLTHDP116	2 1/2 oz, Green - 7 1/8" x 1 3/4" x 1 1/2"	EACH	21.00	12	60	1.20
SLTHDP120	2 oz, Brown - 7 1/8" x 1 5/8" x 1 1/4"	EACH	20.00	12	60	1.20
SLTHDP124	1 1/2 oz, Red - 7 1/8" x 1 1/2" x 1 1/4"	EACH	19.00	12	60	1.20

SLTHDP016

SLTHDP116



SLTHDP024

SLTHDP124



ICE CREAM SPADE

One-piece stainless steel spade with plastic white or black handle. Easily maintained with sponge or soft cloth.

ITEM	DESCRIPTION	U/M	WEIGHT GROSS lbs	INNER PACK	MASTER PACK	CU. FT.
SLTHCS001	White 10" x 3" x 7/8"	EACH	44.09	12	120	1.53
SLTHCS001B	Black 9" x 3" x 1 1/2"	EACH	44.09	12	120	1.27



SLTHCS001

SLTHCS001B

Select cutter model by choosing a blade type with its pusher block.



FRENCH FRY CUTTER SET

Heavy-duty cast iron body, handle & a stainless steel reciprocating rod. The frame, cutter & pusher block are all rust proof. It can be wall or table mounted. Durable and easy to clean.

ITEM	DESCRIPTION	U/M	WEIGHT GROSS lbs	INNER PACK	MASTER PACK	CU. FT.
IRFFC001	Square Cutter Set - w/ 1/4" Blade & Pusher 15 3/4" x 8" x 12 3/4"	EACH	11.30	1	1	0.81
IRFFC002	Square Cutter Set - w/ 3/8" Blade & Pusher 15 3/4" x 8" x 12 3/4"	EACH	11.30	1	1	0.81
IRFFC003	Square Cutter Set - w/ 1/2" Blade & Pusher 15 3/4" x 8" x 12 3/4"	EACH	11.30	1	1	0.81
IRFFC004	Wedge Cutter Set - w/ 6 Wedge Blade & Pusher 15 3/4" x 8" x 12 3/4"	EACH	11.30	1	1	0.81
IRFFC005	Wedge Cutter Set - w/ 8 Wedge Blade & Pusher 15 3/4" x 8" x 12 3/4"	EACH	11.30	1	1	0.81

PARTS

1/4" Square
IRFFC001



ITEM	DESCRIPTION	U/M	WEIGHT GROSS lbs	INNER PACK	MASTER PACK	CU. FT.
IRFFC001B	1/4" Square Blade - 4 5/8" x 4 5/8" x 3/4"	EACH	24.25	6	24	0.40
IRFFC001W	1/4" Square Pusher Block - 3" x 3" x 1"	EACH	7.64	6	24	0.23

3/8" Square
IRFFC002



IRFFC002B	3/8" Square Blade - 4 5/8" x 4 5/8" x 3/4"	EACH	24.25	6	24	0.40
IRFFC002W	3/8" Square Pusher Block - 3" x 3" x 1"	EACH	7.64	6	24	0.23

1/2" Square
IRFFC003



IRFFC003B	1/2" Square Blade - 4 5/8" x 4 5/8" x 3/4"	EACH	24.25	6	24	0.40
IRFFC003W	1/2" Square Pusher Block - 3" x 3" x 1"	EACH	7.64	6	24	0.23

6 Wedge
IRFFC004



IRFFC004B	6 Wedge Blade - 4 5/8" x 4 5/8" x 3/4"	EACH	24.25	6	24	0.40
IRFFC004W	6 Wedge Pusher Block - 3" x 3" x 1"	EACH	7.64	6	24	0.23

8 Wedge
IRFFC005



IRFFC005B	8 Wedge Blade - 4 5/8" x 4 5/8" x 3/4"	EACH	24.25	6	24	0.40
IRFFC005W	8 Wedge Pusher Block - 3" x 3" x 1"	EACH	7.64	6	24	0.23

IRFFC009H



IRFFC009H	Handle for French Fry Cutter - 19 1/4" x 3 1/4" x 2 3/4"	EACH	48.96	12	12	0.85
-----------	---	------	-------	----	----	------



IRFFC104

IRFFC104	French Fry Cutter Suction Cup Feet, PVC, Set of 4, 3 3/4" Diameter x 2 1/8"	SET	21.98	12	24	2.61
----------	--	-----	-------	----	----	------



*French Fry Cutter Sold Separately

FRENCH FRY BAGGER

With removable dual handles. Shovel up and serve fries with fast efficiency. Reduces spills and serves even portions.



18/8 STAINLESS STEEL

ITEM	DESCRIPTION	U/M	WEIGHT GROSS lbs	INNER PACK	MASTER PACK	CU. FT.
SLFFB001	9" x 9" x 2 3/8" with Removable Dual Handle	EACH	74.96	12	72	6.09
SLFFB001L	9" x 9" x 2 3/8" with Left Handle	EACH	6.61	6	6	0.76
SLFFB001R	9" x 9" x 2 3/8" with Right Handle	EACH	6.61	6	6	0.76

TACO SHELL BASKET

Nickel plated basket with stainless steel framework and dividers.

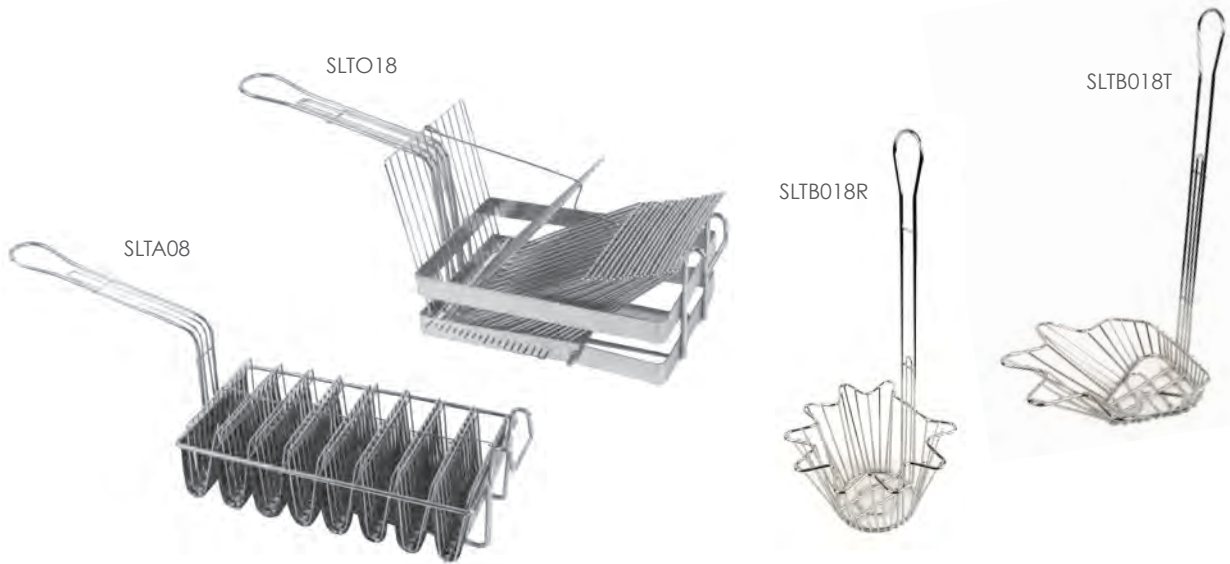

ITEM	DESCRIPTION	U/M	WEIGHT GROSS lbs	INNER PACK	MASTER PACK	CU. FT.
SLTA08	8 Taco Mold 21 1/4" x 6 3/4" x 9"	EACH	24.69	1	8	2.84
SLTO18	18 Slots, Heavy Duty Tostada Shell Baskets 19 3/8" x 6 1/4" x 7 5/8"	EACH	44.09	1	12	5.21
SLTB018R	Taco Salad Bowl Basket - 8 1/8" x 7 1/4" x 18 3/8", Round Base - Bowl Size 8" x 8" x 5"	EACH	17.01	1	12	0.89
SLTB018T	Taco Salad Bowl Basket - 9 1/4" x 8 7/8" x 16 3/4", Triangle Base - Bowl Size 8 3/4" x 9" x 4 1/2"	EACH	16.06	1	12	1.42

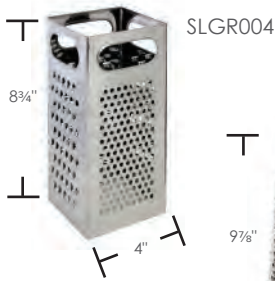

GRATER

Open ended and free standing stainless steel grater with four options at fine to coarse grating. Durable top handles added for stability while in use.



ITEM	DESCRIPTION	U/M	WEIGHT GROSS lbs	INNER PACK	MASTER PACK	CU. FT.
SLGR004	4" Square Grater 4" x 4" x 8 3/4"	EACH	20.24	1	24	2.99
SLGR025	Grater w/ Handle 4 1/4" x 2 7/8" x 9 7/8"	EACH	17.64	1	24	2.41

PEELER

Smooth double edge floating blade with a serrated blade for coring or scraping. Easy to wash.



SLKVP006



OW358

ITEM	DESCRIPTION	U/M	WEIGHT GROSS lbs	INNER PACK	MASTER PACK	CU. FT.
SLKVP006	Peeler, 6" x 1" x 7/16"	DOZEN	7.72	1	12	0.25
SLKVP006RD	Peeler, 6" x 1" x 7/16" 3pc/ set	SET	22.05	8	96	1.60
OW358	Peeler, Black 7 1/2" x 1 1/4" x 1/2"	EACH	24.25	24	240	0.99



Enlarged to show detail.



CHROME PLATED POTATO MASHER WITH WOOD HANDLE

Potato masher with square or round face, with wooden handle. Easy to clean surface.



SLPMR018



SLTMA018

ITEM	DESCRIPTION	U/M	WEIGHT GROSS lbs	INNER PACK	MASTER PACK	CU. FT.
Round						
SLPMR018	18" 4 1/2" Diameter x 18"	EACH	23.15	12	24	2.27
SLPMR024	24" 5 1/8" Diameter x 24"	EACH	31.08	12	24	3.64
Square						
SLTMA012	12" 4 3/8" x 3 3/8" x 14 5/8"	EACH	39.02	12	96	3.15
SLTMA018	18" 5" x 4 1/8" x 18"	EACH	45.19	12	48	2.44
SLTMA024	24" 6 3/8" x 5 1/8" x 24"	EACH	71.94	12	48	3.71

CHROME PLATED POTATO MASHER WITH SOFT GRIP HANDLE

Chrome plated masher with square or round face, with soft grip. Easy to clean surface.



SLTMA018C



SLPMR018C

ITEM	DESCRIPTION	U/M	WEIGHT GROSS lbs	INNER PACK	MASTER PACK	CU. FT.
Round						
SLPMR018C	18" 4 5/8" Diameter x 18"	EACH	31.97	12	24	2.24
SLPMR024C	24" 5 3/16" Diameter x 24"	EACH	39.60	12	24	3.69
Square						
SLTMA018C	18" Square 5" x 4 7/8" x 18"	EACH	35.51	12	24	3.34
SLTMA024C	24" Square 6" x 6" x 24"	EACH	45.64	12	24	6.44

POLYCARBONATE SCOOP

Beveled tip for easy scooping of dry ingredients and ice. Features a hanging hole on the handle.



ITEM	DESCRIPTION	U/M	WEIGHT GROSS lbs	INNER PACK	MASTER PACK	CU. FT.
PLSC006CL	6 oz, 10¼" x 2¾" x 2¼"	EACH	23.81	12	144	2.70
PLSC012CL	12 oz, 11" x 3½" x 2⅝"	EACH	18.74	12	72	1.95
PLSC024CL	24 oz, 12½" x 4" x 2½"	EACH	17.64	12	48	1.94
PLSC064CL	64 oz, 14½" x 5⅝" x 4⅜"	EACH	16.53	12	24	1.80



ALUMINUM SCOOP

Rust-proof. Contoured handle for secure grip.



ITEM	DESCRIPTION	U/M	WEIGHT GROSS lbs	INNER PACK	MASTER PACK	CU. FT.
ALTWSC005	5 oz, 7⅞" x 2¼" x 1¼"	EACH	11.10	12	72	0.81
ALTWSC012	12 oz, 8" x 3¼" x 1⅝"	EACH	19.60	12	72	1.20
ALTWSC024	24 oz, 8½" x 3⅞" x 1⅞"	EACH	39.68	12	72	2.42
ALTWSC038	38 oz, 10⅜" x 3⅞" x 2¾"	EACH	30.90	12	48	2.20
ALTWSC058	58 oz, 12" x 4¾" x 3⅜"	EACH	41.20	12	36	3.70
ALTWSC085	85 oz, 11⅞" x 4⅞" x 3"	EACH	32.30	12	24	2.60



ALUMINUM FLAT BOTTOM SCOOP

Flat shape front with straight edge. Ideal for dry products.



ITEM	DESCRIPTION	U/M	WEIGHT GROSS	INNER PACK	MASTER PACK	CU. FT.
ALTWFC004	4 oz, 8¼" x 2⅞" x 1⅜"	EACH	21.70	12	120	0.80
ALTWFC007	7 oz, 10" x 3⅝" x 2⅜"	EACH	32.40	12	120	1.20
ALTWFC016	16 oz, 10½" x 4" x 2½"	EACH	37.50	12	120	1.50

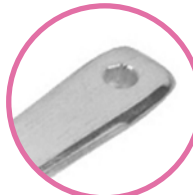

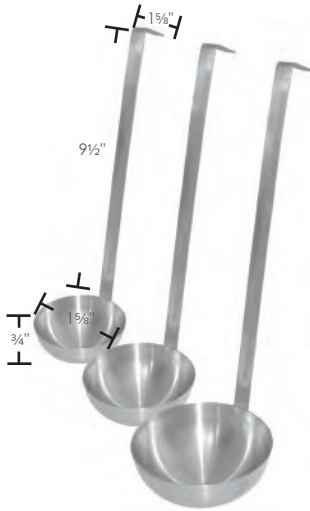

SLTL001 ~ SLTL012



SLOL001 ~ SLOL008



SLGL001

SLSL003



SLSL001

SLSL002

TWO-PIECE LADLE

Available in different sizes. Two piece stainless steel ladle, can be conveniently nested on pot rim or hung on rack. Used for small condiments or large soup pots.



ITEM	DESCRIPTION	U/M	WEIGHT GROSS lbs	INNER PACK	MASTER PACK	CU. FT.
SLTL001	1/2 oz, 1 5/8" Diameter x 3/4" with 9 1/2" x 1/2" Handle, Bend 1 5/8" x 1/2"	EACH	15.43	12	120	1.13
SLTL002	1 oz, 1 7/8" Diameter x 1" with 10" x 1/2" Handle, Bend 1 5/8" x 1/2"	EACH	20.90	12	120	2.08
SLTL003	2 oz, 2 1/2" Diameter x 1 1/4" with 10 1/2" x 1/2" Handle, Bend 1 5/8" x 1/2"	EACH	23.10	12	120	1.41
SLTL004	3 oz, 2 1/2" Diameter x 1 1/4" with 12" x 1/2" Handle, Bend 1 5/8" x 1/2"	EACH	35.27	12	120	2.39
SLTL005	4 oz, 3" Diameter x 1 3/8" with 12" x 1/2" Handle, Bend 1 5/8" x 1/2"	EACH	36.30	12	120	2.83
SLTL006	6 oz, 3 5/8" Diameter x 1 3/4" with 12 5/8" x 5/8" Handle, Bend 1 3/4" x 5/8"	EACH	44.09	12	120	2.96
SLTL007	8 oz, 3 7/8" Diameter x 1 7/8" with 12 5/8" x 5/8" Handle, Bend 1 3/4" x 5/8"	EACH	47.40	12	120	3.86
SLTL008	10 oz, 4 1/4" Diameter x 1 7/8" with 12 5/8" x 5/8" Handle, Bend 1 3/4" x 5/8"	EACH	58.00	12	120	4.11
SLTL009	12 oz, 4 3/4" Diameter x 1 7/8" with 15 1/2" x 3/4" Handle, Bend 1 3/4" x 3/4"	EACH	33.00	6	60	2.58
SLTL010	16 oz, 5" Diameter x 2 1/8" with 15 1/2" x 3/4" Handle, Bend 1 3/4" x 3/4"	EACH	40.00	6	60	4.93
SLTL011	24 oz, 5 5/8" Diameter x 2 1/8" with 16 1/4" x 1" Handle, Bend 1 3/4" x 1"	EACH	47.30	6	60	4.07
SLTL012	32 oz, 6 1/4" Diameter x 3" with 16 1/4" x 1" Handle, Bend 1 3/4" x 1"	EACH	47.40	6	60	4.43

ONE-PIECE LADLE

Can be conveniently stored on pot rim or hung on rack. Used for small condiments or large soup pots.



ITEM	DESCRIPTION	U/M	WEIGHT GROSS lbs	INNER PACK	MASTER PACK	CU. FT.
SLOL001	1/2 oz, 1 3/4" Diameter x 1/2" with 10" x 1/2" Handle, Bend 2 3/8" x 1/2"	EACH	32.46	12	240	1.97
SLOL002	1 oz, 2 1/4" Diameter x 1 7/8" with 10" x 1/2" Handle, Bend 2 3/8" x 1/2"	EACH	37.75	12	240	2.41
SLOL003	2 oz, 2 5/8" Diameter x 1" with 10" x 3/4" Handle, Bend 2 3/8" x 5/8"	EACH	48.86	12	240	2.38
SLOL004	3 oz, 2 5/8" Diameter x 1 1/8" with 11 1/8" x 3/4" Handle, Bend 2 3/4" x 3/4"	EACH	61.56	12	240	5.31
SLOL005	4 oz, 3 1/4" Diameter x 1 1/2" with 11 1/8" x 3/4" Handle, Bend 2 3/4" x 3/4"	EACH	66.32	12	240	6.14
SLOL006	6 oz, 3 3/4" Diameter x 1 5/8" with 11 1/8" x 3/4" Handle, Bend 2 3/4" x 3/4"	EACH	41.71	12	120	2.97
SLOL007	8 oz, 4" Diameter x 1 3/4" with 11 3/4" x 3/4" Handle, Bend 3" x 3/4"	EACH	45.68	12	120	3.32
SLOL007H	10 oz, 4 1/4" Diameter x 1 7/8" with 11 3/4" x 3/4" Handle, Bend 3 1/4" x 3/4"	EACH	50.70	12	120	3.70
SLOL008	12 oz, 4 3/4" Diameter x 1 3/4" with 11 3/4" x 3/4" Handle, Bend 3" x 3/4"	EACH	58.38	12	120	4.99

GRAVY LADLE

For stylish and safe food service. Easy to clean, for many occasions to come.



ITEM	DESCRIPTION	U/M	WEIGHT GROSS lbs	INNER PACK	MASTER PACK	CU. FT.
SLGL001	1 oz Ladle, 2 1/4" Diameter x 5/8" with 5 3/4" x 5/8" Handle	EACH	35.50	12	240	0.80
SLSL003	2 oz Ladle Sunflower, 3" Diameter x 1" with 3 7/8" x 1 1/8" Handle	EACH	40.79	12	120	1.38
SLSL001	4 1/2 oz Ladle Sunflower, 3 3/4" Diameter x 1 3/8" with 9 1/4" x 1 3/8" Handle	EACH	62.17	12	144	1.90
SLSL002	4 oz Ladle Sunflower, 3 1/2" Diameter x 1 1/8" with 9 1/4" x 1 3/8" Handle	EACH	55.78	12	144	1.70

HIGH HEAT NYLON KITCHEN UTENSIL

- * Black Color
- * Heat Resistant up to 410° F



PLPP008BK



PLPP011BK



PLPP004BK



PLPP001BK



PLPP005BK



PLPP009BK



PLPP010BK



PLPP002BK



PLPP007BK

ITEM	DESCRIPTION	U/M	WEIGHT GROSS lbs	INNER PACK	MASTER PACK	CU. FT.
PLPP001BK	12" x 3" x 1½" Turner	EACH	17.18	12	144	1.90
PLPP002BK	12" x 3" x 1½" Spatula	EACH	22.47	12	144	2.32
PLPP003BK	11⅞" x 3" x 1½" Fork	EACH	17.18	12	144	1.90
PLPP004BK	11½" x 3" x 1½" Spoon	EACH	16.52	12	144	1.90
PLPP005BK	11½" x 3" x 1½" Spoon	EACH	16.52	12	144	1.90
PLPP006BK	12½" x 3" x 1½" Skimmer	EACH	20.70	12	144	3.01
PLPP007BK	11⅞" x 3" x 1½" Ladle	EACH	19.52	12	144	2.89
PLPP008BK	12¾" x 3" x 1½" 2-Prong Fork	EACH	17.62	12	144	1.70
PLPP009BK	9½" x 3" x 1½" Masher	EACH	23.35	12	144	3.45
PLPP010BK	12" x 3" x 1½" Turner	EACH	20.93	12	144	3.02
PLPP011BK	12" x 3" x 1½" Turner	EACH	22.16	12	144	3.02
PLPP012BK	12½" x 3" x 1½" Whip	EACH	18.72	12	144	2.89



PLPP012BK



PLPP003BK



PLPP006BK

MULTI-PURPOSE SERVING SPOON



ITEM	DESCRIPTION	U/M	WEIGHT GROSS lbs	INNER PACK	MASTER PACK	CU. FT.
SLTTS001	10", Spoon Size: 3⅞" x 4⅞", Handle: 5⅞"	EACH	48.51	12	144	1.51
SLTTSPO01	8⅞", Spoon Size: 2½" x 3¼", Handle: 5⅞"	EACH	28.67	12	144	1.60



VEGETABLE SPOON

Concave angled stainless steel spoon, with light plastic handle. Easy to clean.

ITEM	DESCRIPTION	U/M	WEIGHT GROSS lbs	INNER PACK	MASTER PACK	CU. FT.
SLLA001	9⅞" x 2¾" x 1⅞" with Plastic Handle	EACH	47.18	10	480	3.42
SLLA002	9⅞" x 2¾" x 1⅞" with Wood Handle	EACH	48.50	10	500	3.81



Made in Taiwan

SLLA002

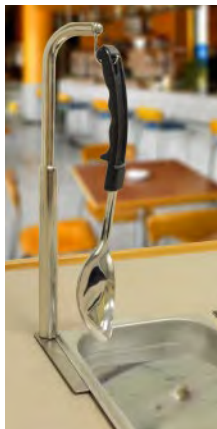

SLTHUH001

BUFFET UTENSIL HOLDER

- Keep the serving areas free of mess
- No more over-heated ladels / spatulas
- Avoid food contamination
- Adjustable height
- Fits most buffet tables

ITEM	DESCRIPTION	U/M	WEIGHT GROSS lbs	INNER PACK	MASTER PACK	CU. FT.
SLTHUH001	Utensil Holder, Hook Style 5" x 5" x 99"	EACH	30.52	6	24	1.73

Patent Pending:
US201502166364 A1

SLSBA411



SLSBA412



SLSBA413



SLSBA511



SLSBA512



SLSBA513



SLSBA611



SLSBA612

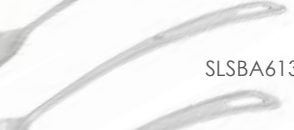

SLSBA613



BASTING SPOON

Ergonomic curved handle. Shiny polished finish.



ITEM	DESCRIPTION	U/M	WEIGHT GROSS lbs	INNER PACK	MASTER PACK	CU. FT.
11 inch						
SLSBA411	11" Solid Basting Spoon, Curved Handle	EACH	29.28	12	120	0.83
SLSBA412	11" Slotted Spoon, Curved Handle	EACH	27.60	12	120	0.83
SLSBA413	11" Perforated Basting Spoon, Curved Handle	EACH	27.73	12	120	0.83
13 inch						
SLSBA511	13" Solid Basting Spoon, Curved Handle	EACH	31.86	12	120	1.03
SLSBA512	13" Slotted Spoon, Curved Handle	EACH	30.53	12	120	1.03
SLSBA513	13" Perforated Basting Spoon, Curved Handle	EACH	30.64	12	120	1.03
15 inch						
SLSBA611	15" Solid Basting Spoon, Curved Handle	EACH	35.76	12	120	1.08
SLSBA612	15" Slotted Spoon, Curved Handle	EACH	34.28	12	120	1.08
SLSBA613	15" Perforated Basting Spoon, Curved Handle	EACH	34.44	12	120	1.08

Basting Covers

With heat-resistant Bakelite knob. Keeps meals warm and moist before serving.



ALBC007



ALBD006

ITEM	DESCRIPTION	U/M	WEIGHT GROSS lbs	INNER PACK	MASTER PACK	CU. FT.
ALBC007	7" Diameter x 2" Height with 1 1/2" Diameter x 1" Height	EACH	17.60	6	48	1.25
ALBC008	8" Diameter x 2" Height with 1 1/2" Diameter x 7/8" Height	EACH	6.20	6	12	0.32
ALBC009	9" Diameter x 2" Height with 1 1/2" Diameter x 1 1/8" Height	EACH	6.60	6	12	0.44
ALBC010	10" Diameter x 2 1/8" Height with 1 1/2" Diameter x 3/4" Height	EACH	7.70	6	12	0.53
ALBD006	6" Diameter x 2 1/4" Height with 1" Diameter x 3/4" Height	EACH	8.80	6	12	0.59

BASTING SPOON

Heavy duty stainless steel spoons with easy grip plastic handle. Safety notch to prevent slippage into pan. Available in solid, slotted, or perforated spoons.

ITEM	DESCRIPTION	U/M	WEIGHT GROSS lbs	INNER PACK	MASTER PACK	CU. FT.
Plastic Handle, 1.2 mm						
SLPBA111	11" Solid - 4 1/8" x 2 5/8", 6 3/4" Handle (included 4 7/8" Black Plastic Grip)	EACH	27.61	12	120	1.54
SLPBA112	11" Slotted - 4 1/8" x 2 5/8", 6 3/4" Handle (included 4 7/8" Black Plastic Grip)	EACH	26.03	12	120	1.54
SLPBA113	11" Perforated - 4 1/8" x 2 5/8", 6 3/4" Handle (included 4 7/8" Black Plastic Grip)	EACH	26.56	12	120	1.54
SLPBA211	13" Solid - 4 1/8" x 2 5/8", 8 3/4" Handle (included 4 7/8" Black Plastic Grip)	EACH	29.47	12	120	2.05
SLPBA212	13" Slotted - 4 1/8" x 2 5/8", 8 3/4" Handle (included 4 7/8" Black Plastic Grip)	EACH	27.09	12	120	2.05
SLPBA213	13" Perforated - 4 1/8" x 2 5/8", 8 3/4" Handle (included 4 7/8" Black Plastic Grip)	EACH	27.61	12	120	2.05
SLPBA311	15" Solid - 4 1/8" x 2 5/8", 10 3/4" Handle (included 4 7/8" Black Plastic Grip)	EACH	32.65	12	120	2.18
SLPBA312	15" Slotted - 4 1/8" x 2 5/8", 10 3/4" Handle (included 4 7/8" Black Plastic Grip)	EACH	29.74	12	120	2.18
SLPBA313	15" Perforated - 4 1/8" x 2 5/8", 10 3/4" Handle (included 4 7/8" Black Plastic Grip)	EACH	30.80	12	120	2.18
Stainless Steel Handle, 1.2 mm						
SLSBA111	11" Solid - 4 1/8" x 2 5/8", 7 1/4" Handle, Hanging Slot: 1 1/2" x 1/2"	EACH	26.03	12	120	0.61
SLSBA112	11" Slotted - 4 1/8" x 2 5/8", 7 1/4" Handle, Hanging Slot: 1 1/2" x 1/2"	EACH	24.97	12	120	0.61
SLSBA113	11" Perforated - 4 1/8" x 2 5/8", 7 1/4" Handle, Hanging Slot: 1 1/2" x 1/2"	EACH	24.97	12	120	0.61
SLSBA211	13" Solid - 4 1/8" x 2 5/8", 8 7/8" Handle, Hanging Slot: 1 1/2" x 1/2"	EACH	30.35	12	120	0.74
SLSBA212	13" Slotted - 4 1/8" x 2 5/8", 8 7/8" Handle, Hanging Slot: 1 1/2" x 1/2"	EACH	29.29	12	120	0.74
SLSBA213	13" Perforated - 4 1/8" x 2 5/8", 8 7/8" Handle, Hanging Slot: 1 1/2" x 1/2"	EACH	29.29	12	120	0.74
SLSBA311	15" Solid - 4 1/8" x 2 5/8", 10 3/4" Handle, Hanging Slot: 1 1/2" x 1/2"	EACH	37.08	12	120	0.80
SLSBA312	15" Slotted - 4 1/8" x 2 5/8", 10 3/4" Handle, Hanging Slot: 1 1/2" x 1/2"	EACH	33.64	12	120	0.80
SLSBA313	15" Perforated - 4 1/8" x 2 5/8", 10 3/4" Handle, Hanging Slot: 1 1/2" x 1/2"	EACH	33.64	12	120	0.80
Extra Long, 1.5 mm						
SLSBA018	18" Solid - 4 1/2" x 2 3/4", 13 7/8" Handle, Hanging Slot: 3/8" Diameter	EACH	53.62	12	120	1.65
SLSBA021	21" Solid - 4 1/2" x 2 3/4", 16 3/4" Handle, Hanging Slot: 3/8" Diameter	EACH	57.85	12	120	2.44

SLPBA111

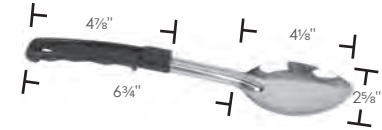

SLPBA112

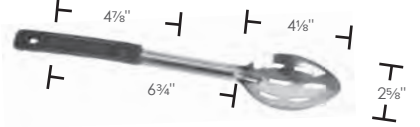

SLPBA113



Perforated Hole: 1/4" & 1/8"



SLSBA111



SLSBA112



SLSBA113



Slot Sizes:
1" x 1/4", 7/8" x 1/4", 2/3" x 1/4"

Hanging Slot:
1 1/2" x 1/2"

Perforated Hole:
1/4" & 1/8" Diameter

SLSBA018



STAINLESS STEEL ONE PIECE COLOR-CODED LADLE

Vinyl color coated to prevent cracking, peeling or slipping off.



ITEM	DESCRIPTION	U/M	WEIGHT GROSS lbs	INNER PACK	MASTER PACK	CU. FT.
SLOL201	½ oz, Teal, 1¾" Diameter x ½" HTS, 10¼" Length x ½" Width Handle (included 4½" Length x ⅝" Width Plastic Grip)	EACH	19.07	12	120	1.27
SLOL202	1 oz, Yellow, 2½" Diameter x ⅞" HTS, 10¼" Length x ½" Width Handle (included 4½" Length x ⅝" Width Plastic Grip)	EACH	23.85	12	120	1.46
SLOL203	2 oz, Red, 2½" Diameter x 1" HTS, 10¼" Length x ¾" Width Handle (included 4¾" Length x ¾" Width Plastic Grip)	EACH	30.48	12	120	1.71
SLOL204	3 oz, Ivory, 2½" Diameter x 1⅛" HTS, 10¾" Length x ¾" Width Handle (included 5¾" Length x ¾" Width Plastic Grip)	EACH	33.82	12	120	2.19
SLOL205	4 oz, Green, 3¼" Diameter x 1½" HTS, 11¾" Length x ¾" Width Handle (included 5¼" Length x ¾" Width Plastic Grip)	EACH	40.24	12	120	2.71
SLOL206	6 oz, Black, 3¾" Diameter x 1⅝" HTS, 12" Length x ¾" Width Handle (included 5½" Length x ¾" Width Plastic Grip)	EACH	49.00	12	120	2.77
SLOL207	8 oz, Blue, 4" Diameter x 1¾" HTS, 12¼" Length x ¾" Width Handle (included 5¾" Length x ¾" Width Plastic Grip)	EACH	27.81	12	60	1.73
SLOL208	12 oz, Gray, 4¾" Diameter x 2" HTS, 12¾" Length x ¾" Width Handle (included 5¾" Length x ¾" Width Plastic Grip)	EACH	32.97	12	60	1.87

SS STAINLESS STEEL Color Coded
Thickness: 0.95mm

POLYCARBONATE ONE PIECE LADLE

One piece ladle can be used to serve hot or cold foods.



ITEM	DESCRIPTION	U/M	WEIGHT GROSS lbs	INNER PACK	MASTER PACK	CU. FT.
PLOP009BG	¾ oz Beige, 8½" x 2¼" x 1⅞"	EACH	11.42	12	120	1.37
PLOP009BK	¾ oz Black, 8½" x 2¼" x 1⅞"	EACH	11.42	12	120	1.37
PLOP009CL	¾ oz Clear, 8½" x 2¼" x 1⅞"	EACH	11.42	12	120	1.37
PLOP009GR	¾ oz Green, 8½" x 2¼" x 1⅞"	EACH	11.42	12	120	1.37
PLOP009RD	¾ oz Red, 8½" x 2¼" x 1⅞"	EACH	11.42	12	120	1.37
PLOP009WH	¾ oz White, 8½" x 2¼" x 1⅞"	EACH	11.42	12	120	1.37
PLOP010BG	1 oz Beige, 10½" x 2⅝" x 1⅞"	EACH	14.07	12	120	1.94
PLOP010BK	1 oz Black, 10½" x 2⅝" x 1⅞"	EACH	14.07	12	120	1.94
PLOP010CL	1 oz Clear, 10½" x 2⅝" x 1⅞"	EACH	14.07	12	120	1.94
PLOP010GR	1 oz Green, 10½" x 2⅝" x 1⅞"	EACH	14.07	12	120	1.94
PLOP010RD	1 oz Red, 10½" x 2⅝" x 1⅞"	EACH	14.07	12	120	1.94
PLOP010WH	1 oz White, 10½" x 2⅝" x 1⅞"	EACH	14.07	12	120	1.94
PLOP013BG	1 oz Beige, 13" x 2⅝" x 2"	EACH	15.67	12	120	1.67
PLOP013BK	1 oz Black, 13" x 2⅝" x 2"	EACH	15.67	12	120	1.67
PLOP013CL	1 oz Clear, 13" x 2⅝" x 2"	EACH	15.67	12	120	1.67
PLOP013GR	1 oz Green, 13" x 2⅝" x 2"	EACH	15.67	12	120	1.67
PLOP013RD	1 oz Red, 13" x 2⅝" x 2"	EACH	15.67	12	120	1.67
PLOP013WH	1 oz White, 13" x 2⅝" x 2"	EACH	15.67	12	120	1.67

BREAK RESISTANT **DISHWASHER SAFE** **SHATTER RESISTANT** **NSF**
PC POLYCARBONATE

POLYCARBONATE SOLID SERVING SPOON

Serving spoons made of polycarbonate.



PLSS211BG PLSS211BK PLSS211CL PLSS211GR PLSS211RD PLSS211WH



ITEM	DESCRIPTION	U/M	WEIGHT GROSS lbs	INNER PACK	MASTER PACK	CU. FT.
PLSS211BG	13" x 2 7/8" x 1 1/16" Beige	DOZEN	10.27	1	6	0.95
PLSS211BK	13" x 2 7/8" x 1 1/16" Black	DOZEN	10.27	1	6	0.95
PLSS211CL	13" x 2 7/8" x 1 1/16" Clear	DOZEN	10.27	1	6	0.95
PLSS211GR	13" x 2 7/8" x 1 1/16" Green	DOZEN	10.27	1	6	0.95
PLSS211RD	13" x 2 7/8" x 1 1/16" Red	DOZEN	10.27	1	6	0.95
PLSS211WH	13" x 2 7/8" x 1 1/16" White	DOZEN	10.27	1	6	0.95

POLYCARBONATE PERFORATED SERVING SPOON

Serving spoon made of polycarbonate.



PLSS213BG PLSS213BK PLSS213CL PLSS213GR PLSS213RD PLSS213WH



ITEM	DESCRIPTION	U/M	WEIGHT GROSS lbs	INNER PACK	MASTER PACK	CU. FT.
PLSS213BG	13" x 2 7/8" x 1 1/16" Beige	DOZEN	10.12	1	6	0.95
PLSS213BK	13" x 2 7/8" x 1 1/16" Black	DOZEN	10.12	1	6	0.95
PLSS213CL	13" x 2 7/8" x 1 1/16" Clear	DOZEN	10.12	1	6	0.95
PLSS213GR	13" x 2 7/8" x 1 1/16" Green	DOZEN	10.12	1	6	0.95
PLSS213RD	13" x 2 7/8" x 1 1/16" Red	DOZEN	10.12	1	6	0.95
PLSS213WH	13" x 2 7/8" x 1 1/16" White	DOZEN	10.12	1	6	0.95

POLYCARBONATE SOLID SERVING SPOON

Serving spoon made of polycarbonate.



PLSS111BG PLSS111BK PLSS111CL PLSS111GR PLSS111RD PLSS111WH

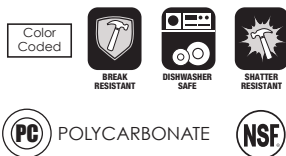

ITEM	DESCRIPTION	U/M	WEIGHT GROSS lbs	INNER PACK	MASTER PACK	CU. FT.
PLSS111BG	11" x 2 7/8" x 1 3/4" Beige	DOZEN	9.33	1	6	0.83
PLSS111BK	11" x 2 7/8" x 1 3/4" Black	DOZEN	9.33	1	6	0.83
PLSS111CL	11" x 2 7/8" x 1 3/4" Clear	DOZEN	9.33	1	6	0.83
PLSS111GR	11" x 2 7/8" x 1 3/4" Green	DOZEN	9.33	1	6	0.83
PLSS111RD	11" x 2 7/8" x 1 3/4" Red	DOZEN	9.33	1	6	0.83
PLSS111WH	11" x 2 7/8" x 1 3/4" White	DOZEN	9.33	1	6	0.83

POLYCARBONATE PERFORATED SERVING SPOON

Serving spoon made of polycarbonate.



PLSS113BG PLSS113BK PLSS113CL PLSS113GR PLSS113RD PLSS113WH

ITEM	DESCRIPTION	U/M	WEIGHT GROSS lbs	INNER PACK	MASTER PACK	CU. FT.
PLSS113BG	11" x 2 7/8" x 1 3/4" Beige	DOZEN	9.33	1	6	0.83
PLSS113BK	11" x 2 7/8" x 1 3/4" Black	DOZEN	9.33	1	6	0.83
PLSS113CL	11" x 2 7/8" x 1 3/4" Clear	DOZEN	9.33	1	6	0.83
PLSS113GR	11" x 2 7/8" x 1 3/4" Green	DOZEN	9.33	1	6	0.83
PLSS113RD	11" x 2 7/8" x 1 3/4" Red	DOZEN	9.33	1	6	0.83
PLSS113WH	11" x 2 7/8" x 1 3/4" White	DOZEN	9.33	1	6	0.83



POLYCARBONATE SOLID BUFFET SPOON

Serving spoon made of polycarbonate.



PLBS010GR PLBS010BK PLBS010CL PLBS010BG PLBS010RD PLBS010WH

ITEM	DESCRIPTION	U/M	WEIGHT GROSS lbs	INNER PACK	MASTER PACK	CU. FT.
PLBS010BG	10" x 1 1/16" x 1", 3/4 oz, Beige	DOZEN	10.14	1	12	0.70
PLBS010BK	10" x 1 1/16" x 1", 3/4 oz, Black	DOZEN	10.14	1	12	0.70
PLBS010CL	10" x 1 1/16" x 1", 3/4 oz, Clear	DOZEN	10.14	1	12	0.70
PLBS010GR	10" x 1 1/16" x 1", 3/4 oz, Green	DOZEN	10.14	1	12	0.70
PLBS010RD	10" x 1 1/16" x 1", 3/4 oz, Red	DOZEN	10.14	1	12	0.70
PLBS010WH	10" x 1 1/16" x 1", 3/4 oz, White	DOZEN	10.14	1	12	0.70



POLYCARBONATE PERFORATED BUFFET SPOON

Serving spoon made of polycarbonate.



PLBS110BG PLBS110BK PLBS110CL PLBS110GR PLBS110RD PLBS110WH

ITEM	DESCRIPTION	U/M	WEIGHT GROSS lbs	INNER PACK	MASTER PACK	CU. FT.
PLBS110BG	10" x 1 1/16" x 1", 3/4 oz, Beige	DOZEN	10.14	1	12	0.70
PLBS110BK	10" x 1 1/16" x 1", 3/4 oz, Black	DOZEN	10.14	1	12	0.70
PLBS110CL	10" x 1 1/16" x 1", 3/4 oz, Clear	DOZEN	10.14	1	12	0.70
PLBS110GR	10" x 1 1/16" x 1", 3/4 oz, Green	DOZEN	10.14	1	12	0.70
PLBS110RD	10" x 1 1/16" x 1", 3/4 oz, Red	DOZEN	10.14	1	12	0.70
PLBS110WH	10" x 1 1/16" x 1", 3/4 oz, White	DOZEN	10.14	1	12	0.70



POLYCARBONATE SCALLOP GRIP TONG

Can be used to serve hot or cold foods.



PLSGTG006BG



PLSGTG006BK



PLSGTG006CL



PLSGTG006GR



PLSGTG006RD



PLSGTG006WH

Color Coded



POLYCARBONATE



ITEM	DESCRIPTION	U/M	WEIGHT GROSS lbs	INNER PACK	MASTER PACK	CU. FT.
PLSGTG006BG	6" x 2¼" x 1¼", Beige	EACH	8.07	12	120	1.05
PLSGTG006BK	6" x 2¼" x 1¼", Black	EACH	8.07	12	120	1.05
PLSGTG006CL	6" x 2¼" x 1¼", Clear	EACH	8.07	12	120	1.05
PLSGTG006GR	6" x 2¼" x 1¼", Green	EACH	8.07	12	120	1.05
PLSGTG006RD	6" x 2¼" x 1¼", Red	EACH	8.07	12	120	1.05
PLSGTG006WH	6" x 2¼" x 1¼", White	EACH	8.07	12	120	1.05
PLSGTG009BG	9" x 3" x 1⅝", Beige	EACH	16.12	12	120	1.66
PLSGTG009BK	9" x 3" x 1⅝", Black	EACH	16.12	12	120	1.66
PLSGTG009CL	9" x 3" x 1⅝", Clear	EACH	16.12	12	120	1.66
PLSGTG009GR	9" x 3" x 1⅝", Green	EACH	16.12	12	120	1.66
PLSGTG009RD	9" x 3" x 1⅝", Red	EACH	16.12	12	120	1.66
PLSGTG009WH	9" x 3" x 1⅝", White	EACH	16.12	12	120	1.66
PLSGTG012BG	12" x 3⅝" x 1¾", Beige	EACH	24.93	12	120	3.02
PLSGTG012BK	12" x 3⅝" x 1¾", Black	EACH	24.93	12	120	3.02
PLSGTG012CL	12" x 3⅝" x 1¾", Clear	EACH	24.93	12	120	3.02
PLSGTG012GR	12" x 3⅝" x 1¾", Green	EACH	24.93	12	120	3.02
PLSGTG012RD	12" x 3⅝" x 1¾", Red	EACH	24.93	12	120	3.02
PLSGTG012WH	12" x 3⅝" x 1¾", White	EACH	24.93	12	120	3.02

POLYCARBONATE FLAT GRIP TONG

Can be used to serve hot or cold food.



PLFTG006BG



PLFTG006BK



PLFTG006CL



PLFTG006GR



PLFTG006RD



PLFTG006WH

Color Coded



POLYCARBONATE



ITEM	DESCRIPTION	U/M	WEIGHT GROSS lbs	INNER PACK	MASTER PACK	CU. FT.
PLFTG006BG	6" x 1⅝" 1", Beige	EACH	9.37	12	120	1.01
PLFTG006BK	6" x 1⅝" 1", Black	EACH	9.37	12	120	1.01
PLFTG006CL	6" x 1⅝" 1", Clear	EACH	9.37	12	120	1.01
PLFTG006GR	6" x 1⅝" 1", Green	EACH	9.37	12	120	1.01
PLFTG006RD	6" x 1⅝" 1", Red	EACH	9.37	12	120	1.01
PLFTG006WH	6" x 1⅝" 1", White	EACH	9.37	12	120	1.01
PLFTG009BG	9" x 2½" x 1⅝", Beige	EACH	18.74	12	120	1.66
PLFTG009BK	9" x 2½" x 1⅝", Black	EACH	18.74	12	120	1.66
PLFTG009CL	9" x 2½" x 1⅝", Clear	EACH	18.74	12	120	1.66
PLFTG009GR	9" x 2½" x 1⅝", Green	EACH	18.74	12	120	1.66
PLFTG009RD	9" x 2½" x 1⅝", Red	EACH	18.74	12	120	1.66
PLFTG009WH	9" x 2½" x 1⅝", White	EACH	18.74	12	120	1.66
PLFTG012BG	12" x 2½" x 1¾", Beige	EACH	38.14	12	120	3.02
PLFTG012BK	12" x 2½" x 1¾", Black	EACH	38.14	12	120	3.02
PLFTG012CL	12" x 2½" x 1¾", Clear	EACH	38.14	12	120	3.02
PLFTG012GR	12" x 2½" x 1¾", Green	EACH	38.14	12	120	3.02
PLFTG012RD	12" x 2½" x 1¾", Red	EACH	38.14	12	120	3.02
PLFTG012WH	12" x 2½" x 1¾", White	EACH	38.14	12	120	3.02

SPRING TONG

Shaped in a rigid form allows flexibility for heavy use.



STAINLESS STEEL

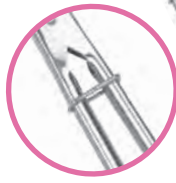

SLTHUT012



SLTHUT107



SLTHUT212

ITEM	DESCRIPTION	U/M	WEIGHT GROSS lbs	INNER PACK	MASTER PACK	CU. FT.
Standard						
SLTHUT010	10" x 1 $\frac{3}{16}$ " x 1 $\frac{3}{8}$ " Flat Spring, Locking Ring	EACH	19.80	12	144	1.42
SLTHUT012	12" x 1 $\frac{1}{4}$ " x 1 $\frac{3}{8}$ " Flat Spring, Locking Ring	EACH	25.96	12	144	1.70
SLTHUT016	16" x 1 $\frac{3}{16}$ " x 1 $\frac{3}{8}$ " Flat Spring, Locking Ring	EACH	44.88	12	144	2.18
Heavy Duty (0.9mm - 1.0mm)						
SLTHUT107	7" x 1 $\frac{3}{8}$ " x 1 $\frac{1}{4}$ " Coiled Spring, Heavy Duty, 0.9mm	EACH	25.31	12	144	1.13
SLTHUT110	10" x 1 $\frac{3}{16}$ " x 1 $\frac{3}{8}$ " Flat Spring, Locking Ring, Heavy Duty, 1 mm	EACH	40.79	12	144	1.36
SLTHUT112	12" x 1 $\frac{3}{16}$ " x 1 $\frac{3}{8}$ " Flat Spring, Locking Ring, Heavy Duty, 1 mm	EACH	55.12	12	144	1.63
SLTHUT116	16" x 1 $\frac{3}{16}$ " x 1 $\frac{3}{8}$ " Flat Spring, Locking Ring, Heavy Duty, 1 mm	EACH	67.24	12	144	2.19
Extra Heavy Duty (1.2mm)						
SLTHUT210	9 $\frac{1}{2}$ " x 1 $\frac{1}{6}$ " x 1" Coiled Spring, Extra Heavy Duty, 1.2 mm	EACH	35.27	12	144	1.56
SLTHUT212	12" x 1 $\frac{1}{4}$ " x 1 $\frac{3}{8}$ " Coiled Spring, Extra Heavy Duty, 1.2 mm	EACH	50.71	12	120	1.65
SLTHUT216	16" x 1 $\frac{3}{16}$ " x 1 $\frac{3}{8}$ " Coiled Spring, Extra Heavy Duty, 1.2 mm	EACH	30.86	12	96	1.89

EGG RING

Contain the egg in a perfect shape while it cooks.



STAINLESS STEEL

SLER0601R



SLER0401S



Frying Pan Sold Separately

ITEM	DESCRIPTION	U/M	WEIGHT GROSS lbs	INNER PACK	MASTER PACK	CU. FT.
Round						
SLER0301R	3" x 5 $\frac{1}{8}$ " Diameter	EACH	19.67	12	216	1.20
SLER0401R	4" x 5 $\frac{1}{8}$ " Diameter	EACH	23.96	12	216	1.27
SLER0501R	5" x 5 $\frac{1}{8}$ " Diameter	EACH	26.34	12	216	1.31
SLER0601R	6" x 5 $\frac{1}{8}$ " Diameter	EACH	32.05	12	216	1.34
Square						
SLER0401S	4" x 4" x 5" Square	EACH	37.29	12	216	1.38



UTILITY TONG

Safely handle food touch free to keep it sanitary.



ITEM	DESCRIPTION	U/M	WEIGHT GROSS lbs	INNER PACK	MASTER PACK	CU. FT.
SLTG309	9" x 3½" x 1¼" Hamburger Tong	EACH	21.73	12	120	0.69
SLTG310	10½" x 6¾" x 1¾" Hamburger Tong	EACH	24.38	12	120	1.98
SLTG407	7½" x 3¾" x 1¼" Cake Tong	EACH	19.88	12	120	0.76
SLTG408	8½" x 3¾" x 1½" Cake Tong	EACH	20.15	12	120	1.18
SLTG607	7½" x 2¾" x 1½" Pastry Tong	EACH	20.41	12	120	0.77
SLTG608	9" x 3½" x 1½" Pastry Tong	EACH	19.62	12	120	0.69
SLTG706	6" x 3¾" x 1¾" Pom Tong	EACH	14.59	12	120	0.31
SLTG709	9" x 4½" x 7/8" Pom Tong	EACH	20.15	12	120	0.64
SLTG712	12" x 4¾" x 1¼" Pom Tong	EACH	38.67	12	120	0.90
SLSR010	10" x 3½" x 1½" Scissor Tong	EACH	37.04	12	144	2.11
SLSR015	15" x 3¼" x 1¾" Scissor Tong	EACH	56.00	12	144	3.33
SLBT075	7½" x 3¾" x 7/8" Bread Tong	DOZEN	20.94	1	25	0.38
SLBT095	9½" x 4" x 1" Bread Tong	DOZEN	26.46	1	25	0.48
SLBT115	11½" x 3¾" x 7/8" Bread Tong	DOZEN	37.48	1	12	0.58
SLIT007	6¼" x 1¾" x 1" Ice Tong	EACH	19.00	24	240	0.62
SLTG208	8" x 1¾" x 2¾" Spaghetti Tong	EACH	35.60	12	288	1.57
SLTTMN008	8" x 2¾" x 1½" Multi-Serving Spoon	EACH	35.71	12	240	3.30
SLTTBN024	9½" x 2¾" x 1½" Barbeque Tong	EACH	34.10	12	360	3.18



NON-SLIP LOCKING UTILITY TONG

Non-slip silicone tips and grip with locking clip.



ITEM	DESCRIPTION	U/M	WEIGHT GROSS lbs	INNER PACK	MASTER PACK	CU. FT.
SLTHUT610	9" x 1¾" x 1½", Silicone Tips and Grip	EACH	24.60	12	72	1.25
SLTHUT612	12" x 1¾" x 1½", Silicone Tips and Grip	EACH	29.92	12	72	1.56





SLTHUT507

NON-SLIP UTILITY TONG

Non-slip silicone tips with sliding locking ring.



ITEM	DESCRIPTION	U/M	WEIGHT GROSS lbs	INNER PACK	MASTER PACK	CU. FT.
SLTHUT507	7" Utility Tong, Silicone Tips	EACH	15.40	24	144	0.92



TONG WITH NON-SLIP HANDLE

Stainless steel tong with coated handles are ideal for touch free, safe and sanitary food service.



ITEM	DESCRIPTION	U/M	WEIGHT GROSS lbs	INNER PACK	MASTER PACK	CU. FT.
SLTG810B	10" x 4 ⁵ / ₈ " x 1 ¹ / ₂ ", Blue	EACH	39.68	12	120	1.63
SLTG810G	10" x 4 ⁵ / ₈ " x 1 ¹ / ₂ ", Green	EACH	39.68	12	120	1.63
SLTG810K	10" x 4 ⁵ / ₈ " x 1 ¹ / ₂ ", Black	EACH	39.68	12	120	1.63
SLTG810R	10" x 4 ⁵ / ₈ " x 1 ¹ / ₂ ", Red	EACH	39.68	12	120	1.63
SLTG810Y	10" x 4 ⁵ / ₈ " x 1 ¹ / ₂ ", Yellow	EACH	39.68	12	120	1.63
SLTG812B	12" x 7 ³ / ₄ " x 1 ¹ / ₂ ", Blue	EACH	46.30	12	120	2.03
SLTG812G	12" x 7 ³ / ₄ " x 1 ¹ / ₂ ", Green	EACH	46.30	12	120	2.03
SLTG812K	12" x 7 ³ / ₄ " x 1 ¹ / ₂ ", Black	EACH	46.30	12	120	2.03
SLTG812R	12" x 7 ³ / ₄ " x 1 ¹ / ₂ ", Red	EACH	46.30	12	120	2.03
SLTG812Y	12" x 7 ³ / ₄ " x 1 ¹ / ₂ ", Yellow	EACH	46.30	12	120	2.03
SLTG816B	16" x 6 ¹ / ₂ " x 1 ¹ / ₂ ", Blue	EACH	62.70	12	120	2.61
SLTG816G	16" x 6 ¹ / ₂ " x 1 ¹ / ₂ ", Green	EACH	62.70	12	120	2.61
SLTG816K	16" x 6 ¹ / ₂ " x 1 ¹ / ₂ ", Black	EACH	62.70	12	120	2.61
SLTG816R	16" x 6 ¹ / ₂ " x 1 ¹ / ₂ ", Red	EACH	62.70	12	120	2.61
SLTG816Y	16" x 6 ¹ / ₂ " x 1 ¹ / ₂ ", Yellow	EACH	62.70	12	120	2.61
SLTG1600B	16" x 5" x 1 ¹ / ₂ " Extra Heavy Duty Tong, Black	EACH	84.70	12	120	3.30
SLTG1600Y	16" x 5" x 1 ¹ / ₂ " Extra Heavy Duty Tong, Yellow	EACH	84.70	12	120	3.30



SLTG810B



SLTG812Y



SLTG816R



SLTG1600B

STEAK WEIGHT and MEAT PRESS



ITEM	DESCRIPTION	U/M	WEIGHT GROSS lbs	INNER PACK	MASTER PACK	CU. FT.
Steak Weight						
SLKSW008	4 1/4" x 8 1/4" x 2 5/8" Aluminum	EACH	14.42	1	12	1.01
SLKSW108	4 1/8" x 8 1/4" x 2 1/2" Cast Iron	EACH	25.91	1	12	1.13
SLKSW095	5" x 9" x 3" Cast Iron	EACH	35.98	1	12	1.25
Meat Press						
SLBP0804W	8" x 4" Chrome Plated Bacon Press, Wood Handle.	EACH	31.97	4	48	2.48
ALHP004A	4 1/2" Hamburger Press, Adjustable From 1/8" to 3/8", Aluminum	EACH	44.53	12	36	2.97

MEAT TENDERIZER

Easy to clean aluminum body. Dual faces for coarse and fine cut options. Stable handle on cast aluminum head.



ITEM	DESCRIPTION	U/M	WEIGHT GROSS lbs	INNER PACK	MASTER PACK	CU. FT.
ALMH001	9 3/4" x 2 3/4" x 1 1/2"	EACH	35.27	12	36	0.74
ALMH002	9 7/8" x 2 7/8" x 2"	EACH	48.50	12	36	1.06
ALMT002	2 sided 10 1/8" x 2 3/4" x 3 1/8"	EACH	44.09	12	48	1.35
ALMTW001	2 sided w/ Wooden Handle 13" x 3" x 3"	EACH	55.12	6	48	2.27



POTATO RICER

Process potatoes by squeezing handles together to make perfect mashed potato effortlessly.



ITEM	DESCRIPTION	U/M	WEIGHT GROSS lbs	INNER PACK	MASTER PACK	CU. FT.
SLPR009	10" x 8" x 4"	EACH	25.30	1	24	3.00
SLPR016	10 3/4" x 4" x 4"	EACH	77.16	1	24	8.10



TURNER

Fit for versatile needs in kitchen. Easy to wipe and clean.



ITEM	DESCRIPTION	BLADE LENGTH	BLADE WIDTH	OVERALL LENGTH	U/M	GROSS WEIGHT lbs	INNER PACK	MASTER PACK	CU. FT.
SLFT065P	Flexible Turner, Plastic Handle Perforated	8½"	3"	15"	EACH	53.90	12	120	2.17
SLFT065S	Flexible Turner, Plastic Handle	8½"	3"	15"	EACH	55.12	12	120	2.17
SLHT064P	Hamburger Turner, Plastic Handle	5¼"	3"	12"	EACH	52.69	12	120	1.52
SLTWBT006	6" Round Blade Turner	6½"	2 7⁄8"	12½"	EACH	30.80	12	72	0.96
SLTWBT010	10" Round Blade Turner Blade: 10" x 3" Handle: 4 5⁄8" x 1" x 3⁄4"	10"	3"	14½"	EACH	37.48	12	72	1.05
SLTWBT075	7½" Straight Blade Turner Blade: 8" x 3" Handle: 4 5⁄8" x 1" x 3⁄4"	8"	3"	12½"	EACH	30.64	12	72	0.96
SLTWBT110	10" Perforated Blade Turner- Hole: 3⁄8" Blade: 10" x 3" Handle: 4 5⁄8" x 1" x 3⁄4"	10"	3"	14½"	EACH	37.08	12	72	1.05
SLTWBT210	10" Solid Blade Turner Blade: 10" x 3" Handle: 4 5⁄8" x 1" x 3⁄4"	10"	3"	14½"	EACH	53.13	12	120	1.64
SLTWHT003	3" x 5" Hamburger Turner	5"	2 7⁄8"	11½"	EACH	31.97	12	72	0.68
SLTWHT004	4" x 8" x 15" Oversize Blade	8"	4"	15½"	EACH	30.86	6	36	0.98
SLTWHT005	4" x 5" Hamburger Turner	5½"	4½"	13½"	EACH	22.05	6	24	0.63
SLTWPS003	3" x 5" Pizza Square Server	4¼"	2¼"	10½"	EACH	36.00	12	180	1.92
SLTWHT008	4" x 8" x 20" Pizza Square Server	9"	4¼"	25½"	EACH	32.75	6	24	1.30
SLTWST010	10" Solid Turner, Long	8"	3"	21"	EACH	33.07	12	48	1.14
SLTWPT003	6" Pancake Turner, Slotted	6"	3"	14"	EACH	29.48	24	120	0.47
SLTWPT003S	6" Pancake Turner, Solid	6"	3"	14"	EACH	35.05	12	144	0.79

SPATULA

Offset spatula is flexible and strong. Offset wood handle for control and hard to reach places.

ITEM	DESCRIPTION	U/M	WEIGHT GROSS lbs	INNER PACK	MASTER PACK	CU. FT.
SLPSP010C	9½" Blade Size 14¾" x 1½" x 2"	EACH	44.00	12	144	1.42



SLPSP010C

ICING SPATULA

Spatula is flexible and strong. Spreads icing smoothly and evenly. Comes with wood handle.

ITEM	DESCRIPTION	U/M	WEIGHT GROSS lbs	INNER PACK	MASTER PACK	CU. FT.
SLPSP008	8" Blade Size 12¾" x 1¾" x ½"	EACH	28.06	24	144	0.59
SLPSP010	10" Blade Size 14¾" x 1¾" x ½"	EACH	28.60	24	144	0.67
SLPSP012	12" Blade Size 16¾" x 1¾" x ½"	EACH	30.86	24	144	0.75
SLPSP014	14" Blade Size 18¾" x 1¾" x ½"	EACH	39.68	24	144	0.83



SLPSP008

POT FORK

Wooden handles are tightly secured onto forks with intensified rivets. Long handle for easy use and safety.

ITEM	DESCRIPTION	U/M	WEIGHT GROSS lbs	INNER PACK	MASTER PACK	CU. FT.
SLTWPF013	13" x 1" x 5/8"	EACH	30.86	12	120	0.81
SLTWPF021	21" x 1" x 5/8"	EACH	28.66	12	72	0.76



SLTWPF013

SLTWPF021

SANDWICH SPREADER

Serrated blade for various textures of sandwich spread. Stainless steel blade with plastic or wood handle and rounded top to avoid tearing.

ITEM	DESCRIPTION	U/M	WEIGHT GROSS lbs	INNER PACK	MASTER PACK	CU. FT.
SLWS004P	4¼" x 1¼" Blade size with Plastic Handle 9½" x 1¾" x ¾"	EACH	23.04	12	120	0.64
SLTWBS007	4" Blade size with Wood Handle, 7⅞" x 1⅝" x 5/8"	EACH	26.46	12	240	0.57



SLWS004P

SLTWBS007

STAINLESS STEEL SKEWER

Food glides easily through the stainless steel pointed edge. Available in tear drop or round hoop handles. Dishwasher safe.



ITEM	DESCRIPTION	U/M	WEIGHT GROSS lbs	INNER PACK	MASTER PACK	CU. FT.
Tear Drop Handle						
SLOK008	8" Oval Skewers	DOZEN	14.50	4	24	0.44
SLOK010	10" Oval Skewers	DOZEN	18.00	4	24	0.49
SLOK012	12" Oval Skewers	DOZEN	21.50	4	24	0.62
Round Hoop Handle						
SLRK008	8" Round Skewers	DOZEN	12.00	4	24	0.33
SLRK010	10" Round Skewers	DOZEN	12.50	4	24	0.22
SLRK012	12" Round Skewers	DOZEN	14.50	4	24	0.25



SLOK

SLRK

PLASTIC SCRAPER

Light and flexible plastic scraper. It can be used for mixing, spreading or scraping. Easy to clean.



ITEM	DESCRIPTION	U/M	WEIGHT GROSS lbs	INNER PACK	MASTER PACK	CU. FT.
Max Temp 185° F - Plastic Blade						
PLSP010	10" x 2 1/8" x 1/2"	EACH	17.64	12	144	1.15
PLSP014	14" x 2 7/8" x 5/8"	EACH	33.00	12	144	1.96
PLSP016	16" x 3 1/8" x 4/5"	EACH	35.20	12	144	2.32
OW364	9 1/2" x 1 3/8" x 3/8", 3" Blade size	EACH	21.83	24	288	0.95
Max Temp 500° F - Silicon Blade						
PLSP010HR	10" x 2 1/8" x 1/2"	EACH	19.80	12	144	2.36
PLSP014HR	14" x 2 5/8" x 3/5"	EACH	46.20	12	144	3.39
PLSP016HR	16" x 3 1/8" x 4/5"	EACH	49.94	12	144	3.72
Max Temp 500° F - Spoon Shape Silicon Blade						
PLSP010SHR	10" x 2 1/8" x 1/2"	EACH	26.40	12	144	3.42
PLSP014SHR	14" x 2 5/8" x 3/5"	EACH	50.60	12	144	4.64
PLSP016SHR	16" x 3 1/8" x 4/5"	EACH	54.56	12	144	5.73



SCRAPER

Flexible satin finish stainless steel blade with plastic or wood handle. Glides on flat surface area to divide or scrape dough.



ITEM	DESCRIPTION	U/M	WEIGHT GROSS lbs	INNER PACK	MASTER PACK	CU. FT.
SLDS060P	6" x 4" x 3/4" Plastic Handle	EACH	48.50	12	120	1.09
SLTWDS006	6" x 4" x 1/2" Wood Handle	EACH	30.86	12	72	0.61
SLTHDS005	5 1/4" x 4 1/4" x 1 3/8" Stainless Steel Handle	EACH	29.76	12	72	1.07
SLPS004P	3" Blade 9 3/4" x 3 1/8" x 7/8" Plastic Handle 4" x 3" Blade Size	EACH	32.49	12	120	0.84
SLTWBS003	3" Blade 8 3/4" x 3 3/16" x 1/2" Wood Handle 4" x 3" Blade Size	EACH	33.07	12	144	0.67
SLTWBS004	4" Blade 8 1/2" x 4" x 7/8" Wood Handle 4 1/2" x 4" Blade Size	EACH	37.48	12	96	0.63





SLMB201 ~ SLMB209

HEAVY DUTY STAINLESS STEEL MIXING BOWLS - (0.8 mm)

Flat base for exceptional balance while mixing. Material endures heavy usage with curved lip for secure handling.



ITEM	DESCRIPTION	U/M	WEIGHT GROSS lbs	INNER PACK	MASTER PACK	CU. FT.
SLMB201	¾ qt, 6½" Diameter x 2¼" Height	EACH	58.00	24	144	0.96
SLMB202	1½ qt, 7⅞" Diameter x 2¾" Height	EACH	61.00	24	96	1.13
SLMB203	3 qt, 9½" Diameter x 3⅝" Height	EACH	66.00	24	72	1.10
SLMB204	4 qt, 11" Diameter x 3½" Height	EACH	77.62	24	72	1.19
SLMB205	5 qt, 11⅝" Diameter x 4" Height	EACH	34.00	12	24	1.16
SLMB206	8 qt, 13⅝" Diameter x 4⅞" Height	EACH	46.00	12	24	1.64
SLMB207	13 qt, 16⅜" Diameter x 5½" Height	EACH	67.00	12	24	2.72
SLMB208	16 qt, 17⅞" Diameter x 5⅝" Height	EACH	76.70	12	24	3.09
SLMB209	20 qt, 19" Diameter x 5⅞" Height	EACH	41.70	12	12	1.71



SLMB001 ~ SLMB030

ECONOMY STAINLESS STEEL MIXING BOWLS

Polished stainless steel mixing bowl helps with preparation of food. Mix salads, sauces, cookie dough and many others in these versatile bowls. Medium weight for easy mobility and handling.



ITEM	DESCRIPTION	U/M	WEIGHT GROSS lbs	INNER PACK	MASTER PACK	CU. FT.
SLMB001	¾ qt, 13⅝" Diameter x 2⅝" Height	EACH	29.76	24	144	0.94
SLMB002	1½ qt, 8" Diameter x 2⅝" Height	EACH	38.76	24	144	1.54
SLMB003	3 qt, 9⅞" Diameter x 3½" Height	EACH	40.59	24	96	1.68
SLMB004	4 qt, 10⅝" Diameter x 3½" Height	EACH	36.66	24	72	1.50
SLMB005	5 qt, 11⅞" Diameter x 4" Height	EACH	43.08	24	72	1.96
SLMB006	8 qt, 13½" Diameter x 5" Height	EACH	20.86	12	24	1.85
SLMB007	13 qt, 16¼" Diameter x 4¾" Height	EACH	34.48	12	24	2.19
SLMB008	16 qt, 17⅜" Diameter x 5⅝" Height	EACH	21.16	12	12	1.34
SLMB009	20 qt, 18⅞" Diameter x 6" Height	EACH	21.12	12	12	1.70
SLMB030	30 qt, 22⅞" Diameter x 7⅞" Height	EACH	39.51	12	12	2.91

COLANDER (HEAVY DUTY)

Easy to clean drain perforations. Bolted handles with stable base for steady mixing, rinsing, and transporting.



ITEM	DESCRIPTION	U/M	WEIGHT GROSS lbs	INNER PACK	MASTER PACK	CU. FT.
ALHDCO001	8 qt w/ Base & Handle, 12 $\frac{3}{8}$ " Diameter x 7 $\frac{1}{2}$ " Height. Handle: 1 $\frac{1}{4}$ ", Bottom Diameter: 9 $\frac{1}{2}$ "	EACH	9.61	4	4	1.57
ALHDCO002	12 qt w/ Base & Handle, 15" Diameter x 7 $\frac{3}{4}$ " Height. Handle: 1 $\frac{3}{4}$ ", Bottom Diameter: 10 $\frac{3}{4}$ "	EACH	12.02	4	4	2.47
ALHDCO003	16 qt w/ Base & Handle, 16 $\frac{1}{2}$ " Diameter x 9 $\frac{5}{8}$ " Height. Handle: 1 $\frac{3}{4}$ ", Bottom Diameter: 11 $\frac{1}{2}$ "	EACH	15.83	4	4	3.70
Heavy Duty						
ALHDCO101	12 qt w/ Base & Handle, 15 $\frac{1}{4}$ " Diameter x 7 $\frac{1}{4}$ " Height. Handle: 1", Bottom Diameter: 11 $\frac{1}{2}$ "	EACH	18.54	4	4	2.45
ALHDCO102	16 qt w/ Base & Handle, 16 $\frac{1}{4}$ " Diameter x 8" Height. Handle: 1 $\frac{1}{2}$ ", Bottom Diameter: 11 $\frac{5}{8}$ "	EACH	18.74	4	4	2.79
ALSAC001	12 qt, 12 $\frac{7}{8}$ " Diameter x 5 $\frac{5}{8}$ " Height	EACH	12.02	1	10	1.08
ALSAC002	15 qt, 16 $\frac{1}{4}$ " Diameter x 7 $\frac{1}{2}$ " Height	EACH	20.94	1	10	2.52



ALHDCO001 ~ ALHDCO003



ALHDCO101 ~ ALHDCO102



ALSAC001 ~ ALSAC002

COLANDER

Free standing colander with mirror finish for hands-free draining. Ideal for rinsing vegetables or pasta.



ITEM	DESCRIPTION	Hole Size	U/M	WEIGHT GROSS lbs	INNER PACK	MASTER PACK	CU. FT.
Colanders with Handles							
SLIL001	3 qt, 9 $\frac{1}{2}$ " Diameter x 4 $\frac{1}{4}$ " Height, Handle: 1 $\frac{1}{4}$ ", Bottom Diameter: 5 $\frac{1}{8}$ "	2.0 mm	EACH	35.50	12	48	3.66
SLIL002	5 qt, 11 $\frac{3}{4}$ " Diameter x 4 $\frac{3}{4}$ " Height, Handle: 1 $\frac{5}{8}$ ", Bottom Diameter: 6 $\frac{1}{4}$ "	2.0 mm	EACH	23.15	6	24	3.66
SLIL003	8 qt, 13 $\frac{1}{2}$ " Diameter x 6 $\frac{3}{8}$ " Height, Handle: 1 $\frac{1}{2}$ ", Bottom Diameter: 7 $\frac{1}{8}$ "	2.0 mm	EACH	14.33	6	12	3.65
SLIL004	13 qt, 15 $\frac{3}{4}$ " Diameter x 6" Height, Handle: 1 $\frac{3}{4}$ ", Bottom Diameter: 7 $\frac{1}{8}$ "	2.0 mm	EACH	19.84	6	12	3.60
Colander - No Handle							
SLCIL11L	11", 11" Diameter x 3 $\frac{3}{8}$ " Height	4.5 mm	EACH	21.60	1	24	0.83
SLCIL11S	11", 11" Diameter x 3 $\frac{3}{8}$ " Height	2.0 mm	EACH	21.60	1	24	0.83
SLCIL13L	13", 13" Diameter x 4 $\frac{1}{2}$ " Height	4.5 mm	EACH	31.97	1	24	1.32
SLCIL13S	13", 13" Diameter x 4 $\frac{1}{2}$ " Height	2.0 mm	EACH	31.97	1	24	1.32
SLCIL15L	15", 15 $\frac{1}{4}$ " Diameter x 5 $\frac{1}{2}$ " Height	4.5 mm	EACH	23.81	1	12	1.57
SLCIL15S	15", 15 $\frac{1}{4}$ " Diameter x 5 $\frac{1}{2}$ " Height	2.0 mm	EACH	23.81	1	12	1.57
Perforated Mixing Bowl							
SLMBP075	$\frac{3}{4}$ qt, 6 $\frac{3}{8}$ " Diameter x 1 $\frac{5}{8}$ " Height	3.0 mm	EACH	26.40	24	144	0.78
SLMBP150	1 $\frac{1}{2}$ qt, 8" Diameter x 8" Height	3.0 mm	EACH	42.90	24	96	1.25
SLMBP200	2 qt, 8 $\frac{3}{4}$ " Diameter x 8 $\frac{1}{4}$ " Height	3.0 mm	EACH	44.00	24	96	1.46



SLIL001



SLCIL11L, SLCIL13L, SLCIL15L



SLMBP075

HEAVY DUTY POLAR BASIN

Slight contoured neck and lip for easy handling. Dent resistant.



ITEM	DESCRIPTION	U/M	WEIGHT GROSS lbs	INNER PACK	MASTER PACK	CU. FT.
SLPH002	12 qt, 17" Diameter x 5½" Height	EACH	28.50	1	10	1.82
SLPH003	16 qt, 18" Diameter x 5½" Height	EACH	35.80	1	10	2.32
SLPH004	22 qt, 21" Diameter x 6¼" Height	EACH	40.00	1	10	3.00
SLPH005	28 qt, 23" Diameter x 6¾" Height	EACH	46.00	1	10	3.55
SLPH007	44 qt, 26" Diameter x 7¾" Height	EACH	57.85	1	10	4.09



SLPH002

WATER LADLE

Welded handle. Rust-free.



ITEM	DESCRIPTION	U/M	WEIGHT GROSS lbs	INNER PACK	MASTER PACK	CU. FT.
SLWL001	2 qt, 8¼" Diameter x 5½" Height	EACH	51.81	1	80	4.40



SLWL001

ROUND WASH BASKET

Perforated plastic colander for cleaning or storing produce and other food items. Easy to clean and can be stacked for storage. Comes in random red or blue colors.



ITEM	DESCRIPTION	U/M	WEIGHT GROSS lbs	INNER PACK	MASTER PACK	CU. FT.
PLWB001	12½" Diameter x 4¼" Height	EACH	13.89	1	35	2.40
PLWB002	11½" Diameter x 3¾" Height	EACH	11.02	1	35	1.92
PLWB003	10" Diameter x 3½" Height	EACH	13.23	1	60	2.21
PLWB004	9" Diameter x 3¾" Height	EACH	11.02	1	60	1.57
PLWB005	8" Diameter x 2¾" Height	EACH	7.72	1	60	0.94



PLWB001 ~ PLWB005

ROUND COLANDER

Perforated plastic colander with grip. Stackable for neat storage. Comes in random red or blue colors.



ITEM	DESCRIPTION	U/M	WEIGHT GROSS lbs	INNER PACK	MASTER PACK	CU. FT.
PLFP001	18½" Diameter x 5¾" Height with Grip	EACH	28.66	1	30	4.35



PLFP001

Durable!

SQUARE COLANDER

Perforated surface for aerating and straining vegetables or other produce. Easy to clean surface, durable and stackable for storage. Comes in random red or blue colors.



ITEM	DESCRIPTION	U/M	WEIGHT GROSS lbs	INNER PACK	MASTER PACK	CU. FT.
PLFB001	21¾" x 17" x 5"	EACH	23.73	1	20	3.91
PLFB002	19¾" x 15½" x 4½"	EACH	19.14	1	20	3.05
PLFB003	18" x 13¾" x 4½"	EACH	17.72	1	20	2.13
PLFB004	15¼" x 12¼" x 3½"	EACH	10.89	1	20	1.24
PLFB005	14¼" x 11¼" x 3"	EACH	8.80	1	20	1.08

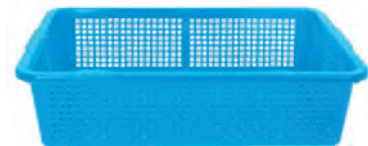

PLFB001 ~ PLFB005



Epoxy Finish



SLWPF010



SLWPP110

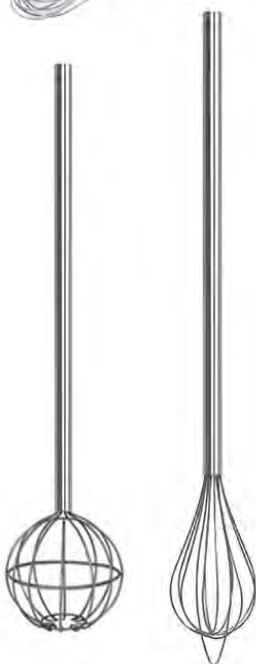

SLKW048

SLMW040



SLKCP008



SLKCP208



SLKCP208R

WHIP

Made for whipping eggs, egg whites and other heavy mixing. Stainless steel wire and handle.



ITEM	DESCRIPTION	U/M	WEIGHT GROSS lbs	INNER PACK	MASTER PACK	CU. FT.
French						
OW362	9¾" French Whip	EACH	50.71	12	240	4.12
SLWPF010	10" French Whip	EACH	28.00	12	60	1.34
SLWPF012	12" French Whip	EACH	32.50	12	60	1.48
SLWPF014	14" French Whip	EACH	30.86	12	60	1.85
SLWPF016	16" French Whip	EACH	33.73	12	60	2.28
SLWPF018	18" French Whip	EACH	37.92	12	60	2.65
SLWPF020	20" French Whip	EACH	42.99	12	60	2.89
SLWPF022	22" French Whip	EACH	46.30	12	60	3.16
Piano						
SLWPP110	10" Piano Whip	EACH	39.24	12	120	2.37
SLWPP112	12" Piano Whip	EACH	41.89	12	120	2.73
SLWPP114	14" Piano Whip	EACH	45.00	12	120	3.09
SLWPP116	16" Piano Whip	EACH	26.01	12	60	2.07
SLWPP118	18" Piano Whip	EACH	28.22	12	60	2.43

DOME AND TEAR DROP SHADE WHIP

Long handle fits for deep mixer bowl application.



ITEM	DESCRIPTION	U/M	WEIGHT GROSS lbs	INNER PACK	MASTER PACK	CU. FT.
SLKW048	48" x 8¾" Diameter Dome Shape	EACH	7.72	1	2	2.15
SLMW040	40" x 5½" Diameter Tear Drop	EACH	5.52	1	2	0.79

CHINA CAP

Pointed mesh securely framed by handle. Choose from coarse mesh or fine mesh. Mesh lining properly serves soups, purees, bisques and sauces.



ITEM	DESCRIPTION	U/M	WEIGHT GROSS lbs	INNER PACK	MASTER PACK	CU. FT.
Coarse						
SLKCP008	2 qt, 8" Diameter x 18½" Length	EACH	18.08	1	12	2.05
SLKCP010	4 qt, 10" Diameter x 20½" Length	EACH	24.25	1	12	3.12
SLKCP012	6 qt, 12" Diameter x 22" Length	EACH	27.56	1	12	4.57
Fine						
SLKCP108	2 qt, 8" Diameter x 18½" Length	EACH	18.08	1	12	2.05
SLKCP110	4 qt, 10" Diameter x 20½" Length	EACH	24.25	1	12	3.12
SLKCP112	6 qt, 12" Diameter x 21¾" Length	EACH	27.56	1	12	4.57

BOUILLON STRAINERS

Choose from fine mesh or reinforced fine mesh. Pan hook provides stability when in use. Mesh lining properly serves soups, purees, bisques and sauces.



ITEM	DESCRIPTION	U/M	WEIGHT GROSS lbs	INNER PACK	MASTER PACK	CU. FT.
SLKCP208	1½ qt, 8" Diameter x 18" Length, Fine Mesh	EACH	14.33	1	12	1.47
SLKCP210	3 qt, 10" Diameter x 19¾" Length, Fine Mesh	EACH	17.64	1	12	2.50
Reinforced						
SLKCP208R	1½ qt, 8" Diameter x 18" Length, Fine Mesh	EACH	17.64	1	12	1.89
SLKCP210R	3 qt, 10" Diameter x 19¾" Length, Fine Mesh	EACH	23.81	1	12	2.80



STRAINER

Fine tin single mesh wires and framework with enclosed wooden handle. Medium tin single mesh wires and framework with enclosed wooden handle.

ITEM	DESCRIPTION	U/M	WEIGHT GROSS lbs	INNER PACK	MASTER PACK	CU. FT.
Fine						
SLSTN3106	6" Single - 6" Diameter x 3 $\frac{3}{8}$ " Height, Handle: 6 $\frac{3}{4}$ "	EACH	27.25	12	48	1.60
SLSTN3108	8" Single - 8" Diameter x 4 $\frac{5}{8}$ " Height, Handle: 6"	EACH	25.26	12	48	2.63
SLSTN3110	10" Single - 10" Diameter x 5 $\frac{1}{2}$ " Height, Handle: 13"	EACH	16.42	6	24	4.32
SLSTN3206	6" Double - 6" Diameter x 3 $\frac{3}{8}$ " Height, Handle: 6 $\frac{3}{4}$ "	EACH	29.45	12	48	1.60
SLSTN3208	8" Double - 8" Diameter x 4 $\frac{5}{8}$ " Height, Handle: 6"	EACH	34.48	12	48	2.63
SLSTN3210	10" Double - 10" Diameter x 5 $\frac{1}{2}$ " Height, Handle: 13"	EACH	17.90	6	24	4.32
Medium						
SLSTN3306	6" Single - 6" Diameter x 3 $\frac{3}{8}$ " Height, Handle: 6 $\frac{3}{4}$ "	EACH	27.25	12	48	1.60
SLSTN3308	8" Single - 8" Diameter x 4 $\frac{5}{8}$ " Height, Handle: 6"	EACH	28.40	12	48	2.63
SLSTN3310	10" Single - 10" Diameter x 5 $\frac{1}{2}$ " Height, Handle: 13"	EACH	25.26	6	24	4.32
SLSTN3406	6" Double - 6" Diameter x 3 $\frac{3}{8}$ " Height, Handle: 6 $\frac{3}{4}$ "	EACH	19.18	12	48	1.60
SLSTN3408	8" Double - 8" Diameter x 4 $\frac{5}{8}$ " Height, Handle: 6"	EACH	29.45	6	48	2.63
SLSTN3410	10" Double - 10" Diameter x 5 $\frac{1}{2}$ " Height, Handle: 13"	EACH	35.85	6	24	4.32



STRAINER

Stainless steel single mesh wires and framework with fine flat wood handle.



ITEM	DESCRIPTION	U/M	WEIGHT GROSS lbs	INNER PACK	MASTER PACK	CU. FT.
Fine						
SLSTN5106	6" Single - 6" Diameter x 2 $\frac{1}{2}$ " Height, Handle: 6 $\frac{1}{2}$ "	EACH	19.40	12	48	1.60
SLSTN5108	8" Single - 8" Diameter x 3" Height, Handle: 6 $\frac{1}{2}$ "	EACH	27.25	12	48	2.64
SLSTN5110	10" Single - 10" Diameter x 4 $\frac{1}{8}$ " Height, Handle: 10 $\frac{3}{4}$ "	EACH	25.26	6	24	4.32
SLSTN5206	6" Double - 6" Diameter x 2 $\frac{1}{2}$ " Height, Handle: 6 $\frac{1}{2}$ "	EACH	16.42	12	48	1.60
SLSTN5208	8" Double - 8" Diameter x 3" Height, Handle: 6 $\frac{1}{2}$ "	EACH	29.45	12	48	2.63
SLSTN5210	10" Double - 10" Diameter x 4 $\frac{1}{8}$ " Height, Handle: 10 $\frac{3}{4}$ "	EACH	34.48	6	24	4.32
Medium						
SLSTN5306	6" Single - 6" Diameter x 2 $\frac{1}{2}$ " Height, Handle: 6 $\frac{1}{2}$ "	EACH	17.90	12	48	1.60
SLSTN5308	8" Single - 8" Diameter x 3" Height, Handle: 6 $\frac{1}{2}$ "	EACH	27.25	12	48	2.63
SLSTN5310	10" Single - 10" Diameter x 4 $\frac{1}{8}$ " Height, Handle: 10 $\frac{3}{4}$ "	EACH	25.26	6	24	4.32
SLSTN5406	6" Double - 6" Diameter x 2 $\frac{1}{2}$ " Height, Handle: 6 $\frac{1}{2}$ "	EACH	19.18	12	48	1.60
SLSTN5408	8" Double - 8" Diameter x 3" Height, Handle: 6 $\frac{1}{2}$ "	EACH	29.45	12	48	2.63
SLSTN5410	10" Double - 10" Diameter x 4 $\frac{1}{8}$ " Height, Handle: 10 $\frac{3}{4}$ "	EACH	35.85	6	24	4.32



STRAINERS (REINFORCED DOUBLE MESH)

Single mesh wires and framework. An extra cross-support on outer mesh.

ITEM	DESCRIPTION	U/M	WEIGHT GROSS lbs	INNER PACK	MASTER PACK	CU. FT.
Flat Handle						
SLSTN3308R	9 $\frac{1}{2}$ " Double/Fine - 9 $\frac{1}{2}$ " Diameter x 5 $\frac{1}{2}$ " Height, Handle: 13"	EACH	8.82	1	6	2.62
SLSTN3310R	10 $\frac{1}{2}$ " Double/Fine - 10 $\frac{1}{2}$ " Diameter x 6 $\frac{3}{8}$ " Height, Handle: 13"	EACH	13.23	1	6	1.49
Round Handle						
SLSTN3312R	11 $\frac{1}{4}$ " Double/Fine - 11 $\frac{3}{4}$ " Diameter x 6 $\frac{1}{2}$ " Height, Handle: 19 $\frac{1}{4}$ "	EACH	15.43	1	6	2.44
SLSTN3314R	13 $\frac{3}{4}$ " Double/Fine - 13 $\frac{3}{4}$ " Diameter x 8" Height, Handle: 19 $\frac{3}{4}$ "	EACH	17.64	1	6	3.40



Nickel Plated

SLSTN3308R



SLSTN3308R



SLSTN3312R

With Extra Cross-Support





SLOS001
SLOS002

OIL SKIMMER

Durable stainless steel with perforations all around. Easy to clean surface.



ITEM	DESCRIPTION	U/M	WEIGHT GROSS lbs	INNER PACK	MASTER PACK	CU. FT.
SLOS001	11" Diameter x 3/4" Height, Handle: 5", Hole: 6mm	EACH	27.56	1	24	1.06
SLOS002	12" Diameter x 3/8" Height, Handle: 4 1/2", Hole: 6mm	EACH	29.70	1	24	1.23

OIL SKIMMER WITH STAINLESS STEEL MESH

Stainless steel mesh and body frame.



SLSK001
SLSK002
SLSK003

ITEM	DESCRIPTION	U/M	WEIGHT GROSS lbs	INNER PACK	MASTER PACK	CU. FT.
SLSK001	9 1/2" Diameter, Handle: 11"	EACH	33.07	12	60	2.30
SLSK002	10 5/8" Diameter, Handle: 11 1/8"	EACH	37.48	12	60	2.30
SLSK003	11 1/4" Diameter, Handle: 11"	EACH	39.68	12	60	2.30

WIRE SKIMMER

Prevents spills and unnecessary mess while frying or cooking. Easy to clean surface.



SLSKS007

SLSKS009

SLSKR513

SLSKS514

SLSKR55

SLSKR65M

SLSKR70M

SLSKR60RL

ITEM	DESCRIPTION	U/M	WEIGHT GROSS lbs	INNER PACK	MASTER PACK	CU. FT.
------	-------------	-----	------------------	------------	-------------	---------

Round Spiral Wire Skimmer, Nickel Plated

SLSKS007	7" x Diameter, Handle: 13"	EACH	44.09	12	48	1.60
SLSKS009	9" x Diameter, Handle: 13"	EACH	52.91	12	48	2.38

Round Wire Skimmer, Nickel Plated

SLSKR513	5" x Diameter, Handle: 12 1/2"	EACH	34.17	12	48	1.03	
SLSKR613	6" x Diameter, Handle: 13"	EACH	36.38	12	48	1.34	Iron Plated
SLSKR713	7" x Diameter, Handle: 12 1/2"	EACH	41.07	12	48	1.60	
SLSKR813	8" x Diameter, Handle: 13"	EACH	42.11	12	48	2.00	
SLSKR913	9" x Diameter, Handle: 13"	EACH	46.30	12	48	2.30	Iron Plated
SLSKR1213	12" x Diameter, Handle: 12 1/2"	EACH	59.52	12	48	4.34	

Square Wire Skimmer, Nickel Plated

SLSKS514	5" x 5", Handle: 13 1/2"	EACH	34.17	12	48	1.07	
SLSKS714	7" x 7", Handle: 12 1/2"	EACH	41.01	12	48	1.73	

Round Fine & Medium Mesh Skimmer, Stainless Steel

SLSKR55	5 1/2" Diameter, Handle: 9 1/2"	EACH	11.02	12	60	1.852	
SLSKR65	6 1/2" Diameter, Handle: 9 1/2"	EACH	13.88	12	60	2.391	
SLSKR65M	6 1/2" Diameter, Handle: 9 1/2"	EACH	14.11	12	60	2.391	
SLSKR70	7" Diameter, Handle: 10 1/2"	EACH	15.65	12	60	2.728	
SLSKR70M	7" Diameter, Handle: 10 1/2"	EACH	16.09	12	60	2.73	
SLSKR875	8 3/4" Diameter, Handle: 10 7/8"	EACH	31.97	12	72	5.787	



Reinforced Extra Long Skimmer

SLSKR60RL	6" Diameter, Handle: 15"	EACH	50.71	12	60	2.75	
SLSKR80RL	8" Diameter, Handle: 18 1/4"	EACH	54.01	12	60	4.04	

STRAINER WITH BLACK PLASTIC HANDLE

Strainer with durable, easy to clean sanitary plastic handle.

ITEM	DESCRIPTION	U/M	WEIGHT GROSS	INNER PACK	MASTER PACK	Cu. Ft.
Fine						
SLSTN5106PB	6", Diameter x 2½" Height, Handle: 6½", Hook: 1"	EACH	19.40	12	48	1.60
SLSTN5108PB	8", Diameter x 3" Height, Handle: 6½", Hook: 1"	EACH	27.25	12	48	2.64
SLSTN5110PB	10", Diameter x 4½" Height, Handle: 10¾", Hook: 1¾"	EACH	25.26	6	24	4.32
SLSTN5206PB	6", Diameter x 2½" Height, Handle: 6½", Hook: 1"	EACH	16.42	12	48	1.60
SLSTN5208PB	8", Diameter x 3" Height, Handle: 6½", Hook: 1"	EACH	29.45	12	48	2.63
SLSTN5210PB	10", Diameter x 4½" Height, Handle: 10¾", Hook: 1¾"	EACH	34.48	6	24	4.32
Medium						
SLSTN5306PB	6", Diameter x 2½" Height, Handle: 6½", Hook: 1"	EACH	17.9	12	48	1.6
SLSTN5308PB	8", Diameter x 3" Height, Handle: 6½", Hook: 1"	EACH	27.25	12	48	2.63
SLSTN5310PB	10", Diameter x 4½" Height, Handle: 10¾", Hook: 1¾"	EACH	25.26	6	24	4.32
SLSTN5406PB	6", Diameter x 2½" Height, Handle: 6½", Hook: 1"	EACH	19.18	12	48	1.6
SLSTN5408PB	8", Diameter x 3" Height, Handle: 6½", Hook: 1"	EACH	29.45	12	48	2.63
SLSTN5410PB	10", Diameter x 4½" Height, Handle: 10¾", Hook: 1¾"	EACH	35.85	6	24	4.32



STAINLESS STEEL STRAINER WITH SUPPORT HANDLE

Stainless steel single mesh wires and framework handle.



ITEM	DESCRIPTION	U/M	WEIGHT GROSS lbs	INNER PACK	MASTER PACK	Cu. Ft.
SLSTN006	6", Diameter x 2¼" Height, Handle: 5¾", Front Hook: ¾"	EACH	18.08	12	72	0.89
SLSTN008	8", Diameter x 2½" Height, Handle: 6¾", Front Hook: ¾"	EACH	28.55	12	72	1.58
SLSTN009	9", Diameter x 2½" Height, Handle: 8", Front Hook: ¾"	EACH	37.48	12	72	2.07
SLSTN010	10", Diameter x 3½" Height, Handle: 8", Front Hook: ¾"	EACH	45.19	12	72	2.694



CULINARY BASKET (NICKEL PLATED)

Heavy nickel-plated wire frame with a securely welded handle. Great for stove top deep-frying.

ITEM	DESCRIPTION	U/M	WEIGHT GROSS	INNER PACK	MASTER PACK	Cu. Ft.
Course						
SLCB008C	8" Diameter x 3" Height, Handle: 9½"	EACH	33.70	1	36	2.00
SLCB010C	10" Diameter x 3" Height, Handle: 9½"	EACH	39.57	1	36	2.40
SLCB012C	12" Diameter x 3" Height, Handle: 9½"	EACH	44.09	1	30	2.80
Fine						
SLCB008F	8" Diameter x 3" Height, Handle: 9½"	EACH	33.07	1	36	2.00
SLCB010F	10" Diameter x 3" Height, Handle: 9½"	EACH	40.12	1	36	2.40
SLCB012F	12" Diameter x 3" Height, Handle: 9½"	EACH	38.58	1	30	2.80



BREADING BASKET (WHITE PLASTIC COATED)

Wire steel breading baskets with white plastic coating. Made for spreading crumbs.
Not intended for frying.

ITEM	DESCRIPTION	U/M	WEIGHT GROSS lbs	INNER PACK	MASTER PACK	Cu. Ft.
Course						
PLBB008C	8" Round, Coarse, 3" Deep, Handle: 9"	EACH	29.55	1	36	2.51
PLBB010C	10" Round, Coarse, 3" Deep, Handle: 9½"	EACH	37.71	1	36	3.17
PLBB012C	12" Round, Coarse, 3" Deep, Handle: 8"	EACH	44.09	1	36	3.60
Medium						
PLBB008M	8" Round, Medium, 3" Deep, Handle: 9"	EACH	27.50	1	36	2.51
PLBB010M	10" Round, Medium, 3" Deep, Handle: 9½"	EACH	31.90	1	36	3.17
PLBB012M	12" Round, Medium, 3" Deep, Handle: 8"	EACH	37.40	1	36	3.60



** Not intended for frying. **

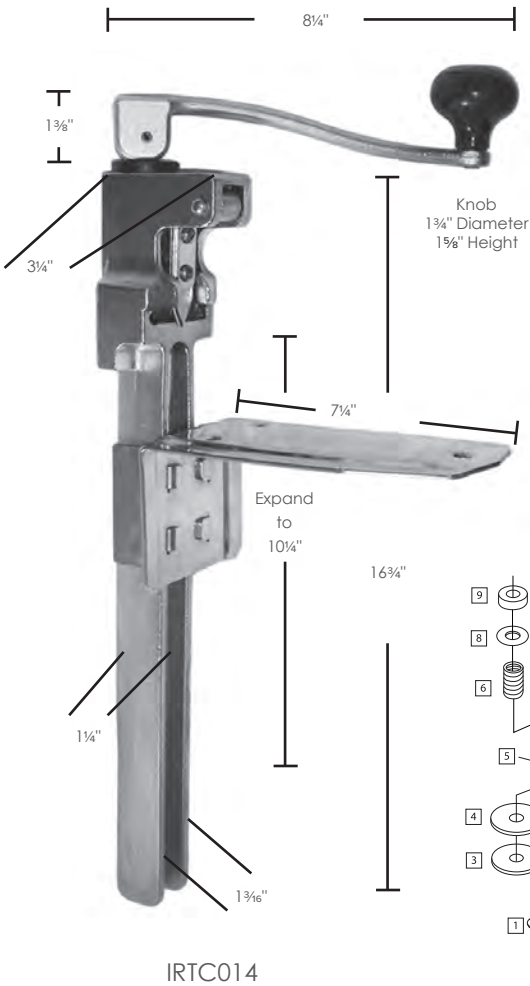

IMPROVED!

TABLE MOUNT CAN OPENER

14" table mounted can opener, heavy duty. This product is made of heavy duty cast iron. It can open up to 10" tall cans. Designed with easily replaceable blade. Essential for any commercial kitchen that serves canned food. Commercial grade quality, made to endure the toughest condition in any kitchen.

ITEM	DESCRIPTION	U/M	WEIGHT GROSS lbs	INNER PACK	MASTER PACK	CU. FT.
IRTC014	Heavy Duty Table Mounted Can Opener	EACH	55.12	1	6	3.06

PARTS

ITEM	DESCRIPTION	U/M
1	IRTC014-01 Screw for Base, Set of 3	SET
2	IRTC014-02 Base	EACH
3	IRTC014-03 Gear	EACH
4	IRTC014-04 Gear Spear	EACH
5	IRTC014-05 Body	EACH
6	IRTC014-06 Spring	EACH
7	IRTC014-07 Arbor	EACH
8	IRTC014-08 Spring Washer	EACH
9	IRTC014-09 Bushing	EACH
10	IRTC014-10 Handle	EACH
11	IRTC014-11 Handle Pin	EACH
12	IRTC014-12 Knob Privet	EACH
13	IRTC014-13 Knob	EACH
14	IRTC014-14 Knife Holder Pin	EACH
15	IRTC014-15 Knife Holder	EACH
16	IRTC014-16 Knife	EACH
17	IRTC014-17 Knife Spear	EACH
18	IRTC014-18 Screw for Knife, Set of 2	SET



JUICER

Aluminum juicer with open slot for juicer cup. Perforated filter with funnel can strain most unwanted pulp and extracts fruit juice down to the last drop. They are efficient and stable manual tools. Featuring sure-grip rubber feet to prevent sliding. Also available in cast iron base, with easy to use autolift handle.

Made in Taiwan

ITEM	DESCRIPTION	U/M	WEIGHT GROSS lbs	INNER PACK	MASTER PACK	CU. FT.
ALJM001	13 $\frac{3}{4}$ " Aluminum Juicer with S/S Cup	EACH	23.15	1	6	2.43
IRJM001	Iron Juicer, Cast Iron Base Auto Lift Handle	EACH	33.07	1	2	2.40

ALJM001
5" x 7" x 14 $\frac{1}{2}$ "
Cup: 4" Diameter x 3 $\frac{1}{4}$ "
Pulp Strainer: 4 $\frac{1}{4}$ " Diameter x 1" Height
Top Pusher to be lifted as high as 17"

IRJM001
5 $\frac{3}{4}$ " x 6 $\frac{3}{4}$ " x 23 $\frac{1}{2}$ "
Cup: 3 $\frac{5}{8}$ " Diameter x 2" Height
Strainer: 4 $\frac{1}{8}$ " Diameter x 2" Height
Strainer Cup: 4 $\frac{1}{2}$ " Diameter x 3 $\frac{1}{2}$ " Height



BRUSH & SCRAPER

Keep your woks clean with these wood handle Palmyra bristles. Smooth and comfortable design. Wire brushes are built tough and come with a scraper to handle heavy duty jobs.

ITEM	DESCRIPTION	U/M	WEIGHT GROSS lbs	INNER PACK	MASTER PACK	CU. FT.
Wok Brush, Palmyra Bristles						
WDWB008	8" x 3" x 3"	EACH	41.89	12	120	4.94
WDWB012	12" x 3" x 3 $\frac{5}{8}$ "	EACH	35.27	12	60	3.80
WDWB020	20" x 2 $\frac{7}{8}$ " x 3 $\frac{1}{2}$ "	EACH	60.50	12	60	6.32
Wire Brush with Scraper						
WDBS011H	11" x 3" x 2 $\frac{5}{8}$ "	EACH	55.12	12	120	3.24
WDBS014	14" x 2 $\frac{5}{8}$ " x 7 $\frac{3}{4}$ "	EACH	55.12	12	120	2.92
WDBS020H	20" x 3" x 2 $\frac{3}{4}$ "	EACH	46.30	12	72	3.83
WDBS027H	27" x 7" x 3"	SET	28.82	1	24	1.59
Oven Brush with Scraper						
WDPB037	37" x 10" x 4 $\frac{1}{2}$ "	SET	20.92	1	12	1.08

WDWB008 WDWB012 WDWB020



WDBS011H

WDBS014

WDBS020H

WDBS027H



WDPB037

Stainless Steel Professional Cookware



Heavy-Duty
Handles

Brushed & Polished
Mirror Finish

Fry Pans
Sauce Pans
Double Boilers
Pasta Cookers
Stock Pots
Brazier Pots

STAINLESS STEEL COOKWARE

Induction ready. Selected Fry pans come with Quantum 2® Coating.

ITEM	DESCRIPTION	U/M	WEIGHT GROSS lbs	INNER PACK	MASTER PACK	CU. FT.
Fry Pan						
SLSFP4008	8" Diameter x 1¾" Height, Handle: 7½"	EACH	9.94	1	6	0.76
SLSFP4009	9½" Diameter x 2¼" Height, Handle: 8"	EACH	13.47	1	6	1.23
SLSFP4011	11" Diameter x 2¾" Height, Handle: 9¾"	EACH	19.29	1	6	1.63
SLSFP4012	12" Diameter x 2½" Height, Handle: 10½", with Helper Handle	EACH	20.28	1	4	1.51
SLSFP4014	14" Diameter x 2¾" Height, Handle: 11½", with Helper Handle	EACH	21.91	1	4	2.24
Fry Pan w/ Quantum 2 Coating						
SLSFP4108	8" Diameter x 1¾" Height, Handle: 7½"	EACH	9.94	1	6	0.75
SLSFP4109	9½" Diameter x 2¼" Height, Handle: 8"	EACH	13.47	1	6	1.23
SLSFP4111	11" Diameter x 2¾" Height, Handle: 9¾"	EACH	19.29	1	6	1.63
SLSFP4112	12" Diameter x 2½" Height, Handle: 10½", with Helper Handle	EACH	20.28	1	4	1.51
SLSFP4114	14" Diameter x 2¾" Height, Handle: 11½", with Helper Handle	EACH	21.91	1	4	2.23



Fry Pan
SLSFP4008 ~ SLSFP4011



Fry Pan w/ Helper Handle
SLSFP4012 ~ SLSFP4014



Fry Pan w/ Quantum 2
SLSFP4108 ~ SLSFP4111



Fry Pan w/ Quantum 2
w/ Helper Handle
SLSFP4112 ~ SLSFP4114

Doubly reinforced to outlast all conventional nonsticks.

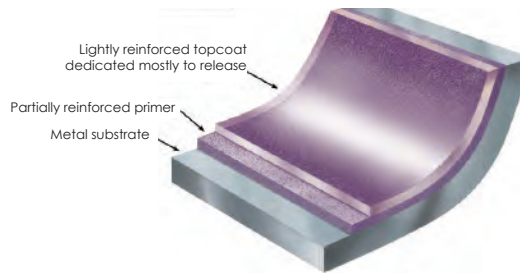

Sauce Pan w/ Lid

SLSSP4020	2 qt - 7" Diameter x 4" Height, Handle: 7¼"	EACH	16.85	1	6	1.88
SLSSP4035	3½ qt - 8¾" Diameter x 4¾" Height, Handle: 8¾"	EACH	24.74	1	6	2.80
SLSSP4045	4½ qt - 8¾" Diameter x 5¾" Height, Handle: 7¾"	EACH	26.19	1	6	3.46
SLSSP4060	6 qt - 10" Diameter x 5¾" Height, Handle: 8¾"	EACH	32.28	1	6	3.78
SLSSP4076	7¾ qt - 10¼" Diameter x 6¾" Height, Handle: 8¾", with Helper Handle: 2¼"	EACH	25.57	1	4	3.85
SLSSP4100	10 qt - 11½" Diameter x 6¾" Height, Handle: 9¾", with Helper Handle: 2¾"	EACH	33.49	1	4	5.08



Sauce Pan w/ Lid
SLSSP4020 ~ SLSSP4060



Sauce Pan and Lid
w/ Helper Handle
SLSSP4076 ~ SLSSP4100



Dishwasher Safe • Easy Clean
Oven Safe 500° F / Oven Safe 260° C
Ceramic Reinforced
Made without PFOA • Made without PFOS

Lid Only
SLDB4008C ~ SLDB4020C



Double Boiler w/ Lid Set
SLDB4008 ~ SLDB4020



Stock Pot w/ Lid
SLSPS4008 ~ SLSPS4100



Lid Only
SLSPS4008C ~ SLSPS4100C

ITEM	DESCRIPTION	U/M	WEIGHT GROSS lbs	INNER PACK	MASTER PACK	CU. FT.
Double Boiler w/ Lid (3 Piece Set)						
SLDB4008	8 qt - 10" Diameter x 7 ⁵ / ₈ " Height, Middle: 8 ⁷ / ₈ " Diameter x 7 ¹ / ₄ " Height, Handle: 2", Overall Height: 8 ³ / ₈ "	SET	36.95	1	4	3.70
SLDB4012	12 qt - 10 ⁷ / ₈ " Diameter x 7 ⁵ / ₈ " Height, Middle: 9 ¹ / ₂ " Diameter x 8 ¹ / ₂ " Height, Handle: 2 ³ / ₈ ", Overall Height: 10"	SET	45.75	1	4	4.89
SLDB4016	16 qt - 11 ⁵ / ₈ " Diameter x 10 ³ / ₄ " Height, Middle: 10 ¹ / ₄ " Diameter x 10" Height, Handle: 2 ⁵ / ₈ ", Overall Height: 12 ¹ / ₂ "	SET	27.69	1	2	3.13
SLDB4020	20 qt - 12 ³ / ₈ " Diameter x 11 ³ / ₄ " Height, Middle: 11" Diameter x 10 ⁵ / ₈ " Height, Handle: 2 ³ / ₈ ", Overall Height: 12 ³ / ₄ "	SET	36.00	1	2	3.59
Double Boiler's Lid Only						
SLDB4008C	Fits SLDB4008 - 10" Diameter x ⁵ / ₈ " Height	EACH	13.69	6	12	1.29
SLDB4012C	Fits SLDB4012 - 11" Diameter x ⁵ / ₈ " Height	EACH	16.96	6	12	1.48
SLDB4016C	Fits SLDB4016 - 11 ⁵ / ₈ " Diameter x ⁵ / ₈ " Height	EACH	19.33	6	12	1.68
SLDB4020C	Fits SLDB4020 - 12 ¹ / ₂ " Diameter x 1" Height	EACH	21.43	6	12	1.89
Stock Pot w/ Lid						
SLSPS4008	8 qt - 10" Diameter x 6 ⁵ / ₈ " Height, Handle: 2 ¹ / ₂ "	EACH	36.38	1	6	3.96
SLSPS4012	12 qt - 11 ⁵ / ₈ " Diameter x 7 ³ / ₈ " Height, Handle: 2 ³ / ₈ "	EACH	47.93	1	6	5.58
SLSPS4016	16 qt - 11 ¹ / ₂ " Diameter x 10" Height, Handle: 2 ⁵ / ₈ "	EACH	35.76	1	4	4.94
SLSPS4020	20 qt - 12 ³ / ₈ " Diameter x 10 ¹ / ₂ " Height, Handle: 2 ¹ / ₂ "	EACH	40.04	1	4	5.57
SLSPS4024	24 qt - 14" Diameter x 10 ³ / ₈ " Height, Handle: 2 ¹ / ₄ "	EACH	55.09	1	4	6.75
SLSPS4032	32 qt - 15" Diameter x 12" Height, Handle: 2 ³ / ₈ "	EACH	15.98	1	1	2.13
SLSPS4040	40 - 16 ⁵ / ₈ " Diameter x 12" Height, Handle: 2 ³ / ₈ "	EACH	19.67	1	1	2.54
SLSPS4060	60 qt - 18 ¹ / ₂ " Diameter x 14 ³ / ₈ " Height, Handle: 2 ³ / ₈ "	EACH	27.57	1	1	3.55
SLSPS4080	80 qt - 20 ³ / ₈ " Diameter x 16" Height, Handle: 2 ³ / ₈ "	EACH	34.53	1	1	4.60
SLSPS4100	100 qt - 20 ¹ / ₂ " Diameter x 19 ⁵ / ₈ " Height, Handle: 2 ³ / ₈ "	EACH	40.17	1	1	5.61
Lids						
SLSPS4008C	Fits SLSPS4008, SLSAP4030, SLSSP4060, SLSSP4076 - 10" Diameter x ¹ / ₂ " Thickness	EACH	13.69	6	12	1.29
SLSPS4012C	Fits SLSPS4012 - 11 ⁵ / ₈ " Diameter x ¹ / ₂ " Thickness	EACH	19.33	6	12	1.68
SLSPS4016C	Fits SLSPS4016 - 11 ¹ / ₂ " Diameter x ⁵ / ₈ " Thickness	EACH	19.33	6	12	1.68
SLSPS4020C	Fits SLSPS4020 & SLSAP4050 - 12 ³ / ₈ " Diameter x ⁵ / ₈ " Thickness	EACH	21.40	6	12	1.89
SLSPS4024C	Fits SLSPS4024 & SLSAP4070 - 14" Diameter x ⁵ / ₈ " Thickness	EACH	30.20	6	12	2.51
SLSPS4032C	Fits SLSPS4032 & SLSBP4015 - 15" Diameter x ¹ / ₂ " Thickness	EACH	41.29	6	12	2.78
SLSPS4040C	Fits SLSPS4040 & SLSBP4020 - 16 ¹ / ₂ " Diameter x ¹ / ₂ " Thickness	EACH	25.76	6	12	3.56
SLSPS4060C	Fits SLSPS4060 & SLSBP4025 - 18 ¹ / ₂ " Diameter x ¹ / ₂ " Thickness	EACH	28.41	6	6	2.29
SLSPS4080C	Fits SLSPS4080 & SLSBP4030 - 20 ³ / ₈ " Diameter x ⁵ / ₈ " Thickness	EACH	33.03	6	6	2.78
SLSPS4100C	Fits SLSPS4100 & SLSBP4030 - 20 ³ / ₈ " Diameter x ⁵ / ₈ " Thickness	EACH	33.25	6	6	2.78



Dishwasher Safe • Easy Clean
Oven Safe 500° F / Oven Safe 260° C
Ceramic Reinforced
Made without PFOA • Made without PFOS

ITEM	DESCRIPTION	U/M	WEIGHT GROSS lbs	INNER PACK	MASTER PACK	CU. FT.
Brazier w/ Lid						
SLSBP4015	15 qt - 15" Diameter x 5¾" Height, Handle: 2¾" (Lid: 15" Diameter x ½" Thickness)	EACH	12.46	1	1	1.20
SLSBP4020	20 qt - 16½" Diameter x 6¼" Height, Handle: 2¾" (Lid: 16½" Diameter x ½" Thickness)	EACH	15.98	1	1	1.50
SLSBP4025	25 qt - 18½" Diameter x 6¼" Height, Handle: 2¾" (Lid: 18½" Diameter x ½" Thickness)	EACH	20.94	1	1	1.75
SLSBP4030	30 qt - 20¾" Diameter x 6¾" Height, Handle: 2¼" (Lid: 20¾" Diameter x ½" Thickness)	EACH	21.89	1	1	2.07



Brazier w/ Lid
SLSBP4015 ~ SLSBP4030

Saute Pan w/ Lid						
SLSAP4030	3 qt Helper Handle - 10" Diameter x 2¾" Height, Handle: 8½", Helper Handle: 2"	EACH	39.88	1	8	3.88
SLSAP4050	5 qt Helper Handle - 12¾" Diameter x 3" Height, Handle: 10¾", Helper Handle: 2¾"	EACH	49.87	1	6	4.65
SLSAP4070	7 qt Helper Handle - 14" Diameter x 3½" Height, Handle: 11¾", Helper Handle: 1¾"	EACH	29.23	1	6	6.08



Saute Pan w/ Lid
SLSAP4030 ~ SLSAP4070

Pasta Cooker w/ Lid - 3 Piece Set						
SLSPC4012	12 qt - 10¾" Diameter x 9¾" Height, Basket: 9¾" Diameter x 8½" Height, Handle: 2¾", Overall Height 11¼"	EACH	45.75	1	4	4.89
SLSPC4020	20 qt - 12¾" Diameter x 11¾" Height, Basket: 11¼" Diameter x 10¾" Height, Handle: 2¾", Overall Height 12¾"	EACH	36.00	1	2	3.59

Lid Only
SLSPC4012C
SLSPC4020C

Pasta Cooker Lids						
SLSPC4012C	Fits SLSPC4012 - 11" Diameter x ½" Thickness	EACH	19.31	6	12	1.68
SLSPC4020C	Fits SLSPC4020 - 12½" Diameter x ¾" Thickness	EACH	21.43	6	12	1.89

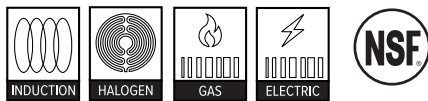

Dishwasher Safe • Easy Clean
Oven Safe 500° F /Oven Safe 260° C
Ceramic Reinforced
Made without PFOA • Made with out PFOS



With
Helper Handle



Pasta Cooker w/ Lid
SLSPC4012
SLSPC4020



Full 3 pc Set



SLTG208 Spaghetti Tong
Sold separately.
See page 305

Aluminum Stock Pot
ALSKSP001 ~ ALSKSP011

Aluminum Stock Pot Lid
ALSKSP101 ~ ALSKSP115



w/ QUAD HANDLES
ALSKSP012
ALSKSP013
ALSKSP014
ALSKSP015



ALUMINUM STOCK POT & LID

Stock pot with commercial thickness for efficient heating. Dent resistant surface to endure the toughest conditions in a professional kitchen. Easy to clean.

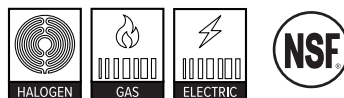

ITEM	DESCRIPTION	U/M	WEIGHT GROSS lbs	INNER PACK	MASTER PACK	CU. FT.
Stock Pots - Regular						
ALSKSP001	8 qt - 10" Diameter x 7 ³ / ₈ " Height, Handle: 1 ³ / ₈ ", 4mm Thickness	EACH	3.75	1	1	0.66
ALSKSP002	12 qt - 10 ¹ / ₄ " Diameter x 9 ¹ / ₄ " Height, Handle: 1 ² / ₃ ", 4mm Thickness	EACH	4.50	1	1	0.88
ALSKSP003	16 qt - 10 ¹ / ₄ " Diameter x 7 ³ / ₈ " Height, Handle: 1 ¹ / ₂ ", 4mm Thickness	EACH	5.75	1	1	1.13
ALSKSP004	20 qt - 12 ¹ / ₄ " Diameter x 11" Height, Handle: 1 ⁵ / ₈ ", 4mm Thickness	EACH	7.05	1	1	1.39
ALSKSP005	24 qt - 13" Diameter x 11 ³ / ₈ " Height, Handle: 1 ² / ₃ ", 4mm Thickness	EACH	4.89	1	1	1.44
ALSKSP006	32 qt - 14 ¹ / ₄ " Diameter x 13" Height, Handle: 1 ³ / ₈ ", 4mm Thickness	EACH	6.24	1	1	1.93
ALSKSP007	40 qt - 14 ³ / ₈ " Diameter x 14 ¹ / ₂ " Height, Handle: 1 ⁵ / ₈ ", 4mm Thickness	EACH	8.82	1	1	1.93
ALSKSP008	50 qt - 16 ³ / ₈ " Diameter x 14 ⁷ / ₈ " Height, Handle: 2", 4mm Thickness	EACH	10.50	1	1	2.80
ALSKSP009	60 qt - 16 ³ / ₈ " Diameter x 17 ³ / ₈ " Height, Handle: 2", 4mm Thickness	EACH	12.79	1	1	3.21
ALSKSP010	80 qt - 19 ¹ / ₄ " Diameter x 17" Height, Handle: 2 ¹ / ₈ ", 4mm Thickness	EACH	15.87	1	1	4.11
ALSKSP011	100 qt - 20 ¹ / ₄ " Diameter x 28 ³ / ₈ " Height, Handle: 2", 4mm Thickness	EACH	17.42	1	1	4.83
w/ Quad Handles						
ALSKSP012	120 qt - 22" Diameter x 19 ³ / ₈ " Height, Handle: 2 ⁵ / ₈ ", 6mm Thickness	EACH	20.94	1	1	6.24
ALSKSP013	140 qt - 23" Diameter x 19 ³ / ₄ " Height, Handle: 2 ¹ / ₂ ", 6mm Thickness	EACH	22.75	1	1	6.96
ALSKSP014	160 qt - 24 ¹ / ₄ " Diameter x 21 ³ / ₄ " Height, Handle: 1 ⁵ / ₈ ", 6mm Thickness	EACH	25.58	1	1	7.93
ALSKSP015	200 qt - 24 ³ / ₈ " Diameter x 27 ³ / ₈ " Height, Handle: 1 ⁵ / ₈ ", 6mm Thickness	EACH	27.56	1	1	9.75
Lids						
1.5 mm Thickness						
ALSKSP101	Fits ALSKSP001 & ALSKSP601, 9 ³ / ₄ " Diameter x 1 ¹ / ₄ " Height	EACH	7.94	1	6	0.32
ALSKSP102	Fits ALSKSP002 & ALSKSP602, 10 ⁵ / ₈ " Diameter x 1 ¹ / ₄ " Height	EACH	8.38	1	6	0.38
ALSKSP103	Fits ALSKSP003 & ALSKSP603, 11 ¹ / ₈ " Diameter x 1 ¹ / ₄ " Height	EACH	7.50	1	6	0.49
ALSKSP104	Fits ALSKSP004 & ALSKSP604, 13" Diameter x 1 ¹ / ₄ " Height	EACH	8.00	1	6	0.54
ALSKSP105	Fits ALSKSP005 & ALSKSP605, 13 ¹ / ₂ " Diameter x 1 ¹ / ₄ " Height	EACH	9.04	1	6	0.62
ALSKSP106	Fits ALSKSP006 & ALSKSP606, 13 ³ / ₈ " Diameter x 1 ¹ / ₄ " Height	EACH	9.46	1	6	0.71
ALSKSP107	Fits ALSKSP007 & ALSKSP607, 15 ³ / ₈ " Diameter x 1 ¹ / ₄ " Height	EACH	9.68	1	6	0.72
1.8 mm Thickness						
ALSKSP108	Fits ALSKSP008 & ALSKSP608, 16 ³ / ₄ " Diameter x 1 ¹ / ₄ " Height	EACH	11.24	1	6	0.88
ALSKSP109	Fits ALSKSP009 & ALSKSP609, 16 ³ / ₄ " Diameter x 1 ¹ / ₄ " Height	EACH	11.22	1	6	0.88
ALSKSP110	Fits ALSKSP010 & ALSKSP610, 19 ³ / ₄ " Diameter x 1 ¹ / ₄ " Height	EACH	12.57	1	6	1.19
ALSKSP111	Fits ALSKSP011 & ALSKSP611, 20 ³ / ₈ " Diameter x 1 ¹ / ₄ " Height	EACH	11.89	1	6	1.33
ALSKSP112	Fits ALSKSP012, 22 ³ / ₄ " Diameter x 1 ¹ / ₄ " Height	EACH	13.45	1	6	1.47
ALSKSP113	Fits ALSKSP013, 22 ³ / ₄ " Diameter x 1 ¹ / ₄ " Height	EACH	13.90	1	6	1.74
ALSKSP114	Fits ALSKSP014, 24 ³ / ₈ " Diameter x 1 ¹ / ₄ " Height	EACH	13.90	1	6	1.74
ALSKSP115	Fits ALSKSP015, 24 ³ / ₄ " Diameter x 1 ¹ / ₄ " Height	EACH	13.90	1	6	1.88





Heavy Duty Aluminum Stock Pot
6 mm Wall Thickness

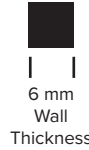

HEAVY DUTY ALUMINUM STOCK POT

Constructed with industrial strength riveted loop handles. These heavy duty stock pots provide excellent heat distribution. Dent resistant surface with wall thickness of 6 mm can endure the toughest conditions in a professional kitchen. Capacity ranges from 8 qt to 100 qt.

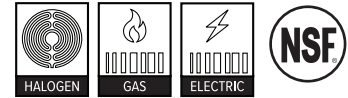

ITEM	DESCRIPTION	U/M	WEIGHT GROSS lbs	INNER PACK	MASTER PACK	CU. FT.
ALSKSP601	8 qt - 9 ⁵ / ₈ " Diameter x 7 ¹ / ₂ " Height, Handle: 1 ³ / ₈ "	EACH	6.36	1	1	0.57
ALSKSP602	12 qt - 10 ¹ / ₂ " Diameter x 9 ¹ / ₂ " Height, Handle: 1 ³ / ₈ "	EACH	7.47	1	1	0.81
ALSKSP603	16 qt - 11 ¹ / ₂ " Diameter x 10 ¹ / ₄ " Height, Handle: 1 ³ / ₈ "	EACH	8.46	1	1	1.01
ALSKSP604	20 qt - 12 ³ / ₈ " Diameter x 11 ¹ / ₄ " Height, Handle: 1 ³ / ₈ "	EACH	9.82	1	1	1.15
ALSKSP605	24 qt - 13" Diameter x 11 ¹ / ₂ " Height, Handle: 1 ¹ / ₂ "	EACH	10.18	1	1	1.32
ALSKSP606	32 qt - 14 ³ / ₈ " Diameter x 13" Height, Handle: 1 ³ / ₈ "	EACH	11.53	1	1	1.76
ALSKSP607	40 qt - 15" Diameter x 14 ¹ / ₂ " Height, Handle: 1 ¹ / ₂ "	EACH	12.59	1	1	2.12
ALSKSP608	50 qt - 16 ³ / ₈ " Diameter x 15" Height, Handle: 2"	EACH	14.68	1	1	2.61
ALSKSP609	60 qt - 16 ³ / ₈ " Diameter x 17 ¹ / ₃ " Height, Handle: 1 ³ / ₃ "	EACH	16.17	1	1	3.00
ALSKSP610	80 qt - 19 ¹ / ₄ " Diameter x 17" Height, Handle: 1 ³ / ₄ "	EACH	18.56	1	1	3.97
ALSKSP611	100 qt - 20 ³ / ₈ " Diameter x 18 ¹ / ₂ " Height, Handle: 2"	EACH	20.48	1	1	5.00

ALUMINUM STEAMER BASKET FOR STOCK POT

Aluminum cylindrical steamer basket with perforated holes for steaming vegetables, seafood, or deep frying large poultry. Fits inside stock pots of 16 qt to 100 qt. Easy lift pail handle and smooth mirror finish that's easy to wash and maintain.

ITEM	DESCRIPTION	U/M	WEIGHT GROSS lbs	INNER PACK	MASTER PACK	CU. FT.
ALSKBK002	Fits 16 qt ALSKSP003, 9 ³ / ₄ " Diameter x 8 ³ / ₈ " Height, Rolled Edge: ¹ / ₄ ", Handle: 5", Bottom: 9 ¹ / ₄ " Diameter	EACH	1.90	1	1	0.55
ALSKBK003	Fits 20 qt ALSKSP004, 10 ¹ / ₂ " Diameter x 8 ³ / ₄ " Height, Rolled Edge: ¹ / ₄ ", Handle: 5 ³ / ₄ ", Bottom: 9 ¹ / ₄ " Diameter	EACH	2.36	1	1	0.51
ALSKBK005	Fits 24 qt ALSKSP005, 11 ³ / ₈ " Diameter x 9 ¹ / ₂ " Height, Rolled Edge: ³ / ₈ ", Handle: 6 ¹ / ₄ ", Bottom: 10 ⁷ / ₈ " Diameter	EACH	2.59	1	1	1.05
ALSKBK006	Fits 32 qt ALSKSP006, 12 ¹ / ₄ " Diameter x 10 ¹ / ₂ " Height, Rolled Edge: ³ / ₈ ", Handle: 6 ⁵ / ₈ ", Bottom: 11 ³ / ₄ " Diameter	EACH	3.00	1	1	0.79
ALSKBK007	Fits 40 qt ALSKSP007, 13 ³ / ₈ " Diameter x 11" Height, Rolled Edge: ³ / ₈ ", Handle: 6 ⁷ / ₈ ", Bottom: 12 ³ / ₄ " Diameter	EACH	3.91	1	1	1.34
ALSKBK008	Fits 50 qt ALSKSP008 & 60 qt ALSKSP009, 14 ¹ / ₂ " Diameter x 12 ⁵ / ₈ " Height, Rolled Edge: ³ / ₈ ", Handle: 7 ³ / ₄ ", Bottom: 13 ⁵ / ₈ " Diameter	EACH	5.00	1	1	1.62
ALSKBK010	Fits 80 qt ALSKSP010, 16 ³ / ₈ " Diameter x 14" Height, Rolled Edge: ³ / ₈ ", Handle: 8 ³ / ₄ ", Bottom: 15 ¹ / ₂ " Diameter	EACH	5.86	1	1	2.09
ALSKBK012	Fits 100 qt ALSKSP011, 18 ¹ / ₄ " Diameter x 15 ³ / ₈ " Height, Rolled Edge: ³ / ₈ ", Handle: 9", Bottom: 17 ¹ / ₄ " Diameter	EACH	6.88	1	1	2.55

Steamer Basket
ALSKBK002 ~ ALSKBK012



ALUMINUM SAUTE PAN & LID

Snug lid is an exact fit to prevent spills while cooking. Flat bottom assures even cooking with rounded edges for smooth stirring.

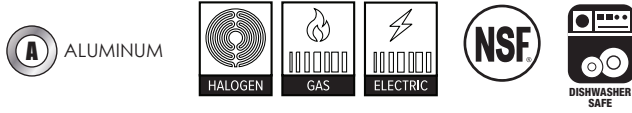

ITEM	DESCRIPTION	U/M	WEIGHT GROSS lbs	INNER PACK	MASTER PACK	CU. FT.
Saute Pan - 3.5 mm						
ALSAP001	2 qt - 8 $\frac{3}{8}$ " Diameter x 3 $\frac{1}{2}$ " Height, Handle: 6 $\frac{5}{8}$ "	EACH	11.86	1	6	0.96
ALSAP002	3 qt - 10 $\frac{3}{8}$ " Diameter x 3 $\frac{1}{2}$ " Height, Handle: 8"	EACH	17.00	1	6	2.14
ALSAP003	5 qt - 12" Diameter x 5 $\frac{1}{2}$ " Height, Handle: 9 $\frac{3}{4}$ "	EACH	21.83	1	6	3.34
ALSAP004	7 qt - 14 $\frac{1}{4}$ " Diameter x 4 $\frac{5}{8}$ " Height, Handle: 12 $\frac{1}{4}$ "	EACH	34.00	1	6	2.92
Cover						
ALSAP101	Fits ALSAP001, 7 $\frac{1}{2}$ " Diameter x 1 $\frac{1}{4}$ " Height	EACH	3.17	1	6	0.28
ALSAP102	Fits ALSAP002, 9 $\frac{1}{2}$ " Diameter x 1 $\frac{1}{4}$ " Height	EACH	5.50	1	6	0.37
ALSAP103	Fits ALSAP003, 11 $\frac{1}{2}$ " Diameter x 1 $\frac{1}{4}$ " Height	EACH	7.94	1	6	0.49
ALSAP104	Fits ALSAP004, 13 $\frac{3}{8}$ " Diameter x 1 $\frac{1}{4}$ " Height	EACH	11.03	1	6	0.92

ALUMINUM SAUCE POT & LID

Dent resistant surface to endure professional kitchen duties. Lid prevents contamination from unwanted food residue. Easy to clean.

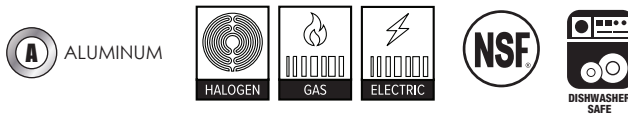

ITEM	DESCRIPTION	U/M	WEIGHT GROSS lbs	INNER PACK	MASTER PACK	CU. FT.
Sauce Pot						
ALSKSU005	5 qt - 8 $\frac{1}{2}$ " Diameter x 5 $\frac{1}{4}$ " Height, Handle: 1 $\frac{3}{8}$ "	EACH	5.06	1	1	0.35
ALSKSU008	8 qt - 10 $\frac{3}{8}$ " Diameter x 6 $\frac{3}{8}$ " Height, Handle: 1 $\frac{3}{8}$ "	EACH	5.28	1	1	0.59
ALSKSU014	14 qt - 12 $\frac{1}{4}$ " Diameter x 7 $\frac{1}{2}$ " Height, Handle: 1 $\frac{3}{4}$ "	EACH	9.46	1	1	0.94
ALSKSU020	20 qt - 13 $\frac{3}{4}$ " Diameter x 8 $\frac{5}{8}$ " Height, Handle: 1 $\frac{3}{4}$ "	EACH	9.92	1	1	1.25
ALSKSU026	26 qt - 14 $\frac{1}{4}$ " Diameter x 10" Height, Handle: 1 $\frac{3}{4}$ "	EACH	10.58	1	1	1.41
ALSKSU036	36 qt - 16 $\frac{1}{8}$ " Diameter x 9 $\frac{7}{8}$ " Height, Handle: 2"	EACH	12.57	1	1	1.87
ALSKSU040	40 qt - 18 $\frac{1}{4}$ " Diameter x 10 $\frac{5}{8}$ " Height, Handle: 2"	EACH	14.00	1	1	2.22
ALSKSU060	60 qt - 20 $\frac{1}{4}$ " Diameter x 11 $\frac{1}{8}$ " Height, Handle: 2 $\frac{1}{8}$ "	EACH	15.84	1	1	3.04
Lid						
ALSKSU105	Fits ALSKSU005, 9" Diameter x $\frac{5}{8}$ " Height	EACH	2.81	1	6	0.24
ALSKSU108	Fits ALSKSU008, 11" Diameter x $\frac{5}{8}$ " Height	EACH	4.07	1	6	0.41
ALSKSU114	Fits ALSKSU014, 12 $\frac{5}{8}$ " Diameter x $\frac{5}{8}$ " Height	EACH	5.38	1	6	0.55
ALSKSU120	Fits ALSKSU020, 13 $\frac{3}{4}$ " Diameter x $\frac{5}{8}$ " Height	EACH	7.17	1	6	0.58
ALSKSU126	Fits ALSKSU026, 14 $\frac{5}{8}$ " Diameter x $\frac{5}{8}$ " Height	EACH	7.40	1	6	0.64
ALSKSU136	Fits ALSKSU036, 16 $\frac{3}{4}$ " Diameter x $\frac{5}{8}$ " Height	EACH	11.26	1	6	0.83
ALSKSU140	Fits ALSKSU040, 18 $\frac{3}{4}$ " Diameter x $\frac{5}{8}$ " Height	EACH	13.99	1	6	1.07
ALSKSU160	Fits ALSKSU060, 20 $\frac{3}{4}$ " Diameter x $\frac{5}{8}$ " Height	EACH	17.03	1	6	1.48

ALUMINUM BRAZIER POT WITH LID (EXTRA HEAVY)

Extra-heavy 6 mm thick aluminum brazier pots with lids. Mirror-finished surface allows easy maintenance. Flat bottom for even level cooking. Capacity ranges from 8 qt to 40 qt.



Made in Korea

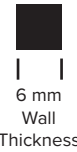

Brazier Pot w/ Lid
ALSKBP001 ~ ALSKBP008

ITEM	DESCRIPTION	U/M	WEIGHT GROSS lbs	INNER PACK	MASTER PACK	CU. FT.
ALSKBP001	8 qt - 11½" Diameter x 5½" Height, Handle: 1¾", Lid: 11¾" Diameter x ¾", Handle: 1"	EACH	6.60	1	1	0.67
ALSKBP002	12 qt - 13¼" Diameter x 5½" Height, Handle: 1¾", Lid: 13¾" Diameter x ¾", Handle: 1"	EACH	9.68	1	1	0.85
ALSKBP003	14 qt - 14¼" Diameter x 5½" Height, Handle: 1¾", Lid: 14¾" Diameter x ¾", Handle: 1"	EACH	9.75	1	1	0.97
ALSKBP004	20 qt - 16¾" Diameter x 5½" Height, Handle: 2½", Lid: 16¾" Diameter x ¾", Handle: 1"	EACH	10.12	1	1	1.25
ALSKBP005	24 qt - 18¼" Diameter x 5½" Height, Handle: 2½", Lid: 18½" Diameter x ¾", Handle: 1"	EACH	9.90	1	1	1.45
ALSKBP006	30 qt - 20¼" Diameter x 5½" Height, Handle: 2½", Lid: 20¾" Diameter x ¾", Handle: 1"	EACH	12.13	1	1	1.58
ALSKBP007	35 qt - 21¾" Diameter x 5¾" Height, Handle: 2½", Lid: 22½" Diameter x ¾", Handle: 1"	EACH	12.79	1	1	1.97
ALSKBP008	40 qt - 23¼" Diameter x 5¾" Height, Handle: 2½", Lid: 23¾" Diameter x ¾", Handle: 1"	EACH	18.48	1	1	2.47

ALUMINUM PASTA COOKER SET

Facilitates cooking pasta to the right texture and consistency. Capacity from 12 qt to 20 qt. ALSKPC005 (5 piece set) features four sectioned perforated strainers to allow quick and multiple pasta cooking without constantly replacing the water. Easy to clean.



ITEM	DESCRIPTION	U/M	WEIGHT GROSS lbs	INNER PACK	MASTER PACK	CU. FT.
ALSKPC005	20 qt, 5 PC Set - 14½" Diameter x 7½" Height, Handle: 1¾"	SET	12.00	1	1	1.93
ALSKPC112	12 qt, 3 PC Set - 10½" Diameter x 9½" Height, Handle: 1¾", Middle: 9¼" Diameter x 9½" Height, Lid: 11¼" Diameter x ¾" Height, Handle: 1"	SET	7.75	1	1	1.13
ALSKPC120	20 qt, 3 PC Set - Outer Pot: 11¾" Diameter x 9¾" Height, Handle: 1¾". Middle Pot: 11¼" Diameter x 9¾" Height. Lid 13¼" x ¾", Lid Handle: 1"	SET	10.00	1	1	1.58

Pasta Cooker ALSKPC005

w/ Stainless Steel Sectioned Perforated Strainers



Pasta Cooker

ALSKPC112
ALSKPC120



ALRP9604



ALRP9603



ALUMINUM DOUBLE ROASTER

Aluminum roasters with straps and lugs for **secure and spill-proof roast**. Pan without bottom is also available. Two durable handles on the front and back to allow level transport. Made with rounded corners and smooth surface for easy cleaning. **2.2 mm/12 gauge**. -40° F ~ 600° F



ITEM	DESCRIPTION	U/M	WEIGHT GROSS lbs	INNER PACK	MASTER PACK	CU. FT.
ALRP9603	18" x 24" x 4½" w/ Strap	EACH	37.69	1	4	3.45
ALRP9604	18" x 24" x 4½" w/ Strap & Lug	EACH	37.69	1	4	3.52
ALRP9605	18" x 24" x 4½"	EACH	36.25	1	4	3.95

ALRP9605

ALUMINUM SAUCE PAN & LID

Durable and dent resistant. Flat bottom for even heat distribution.

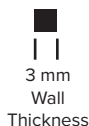

Sauce Pan
ALSKSS001 ~ ALSKSS007



Sauce Pan
ALSKSS008



Lid Only
ALSKSS101 ~ ALSKSS108

ITEM	DESCRIPTION	U/M	WEIGHT GROSS lbs	INNER PACK	MASTER PACK	CU. FT.
Sauce Pans						
ALSKSS001	2.6mm - 1½ qt - 6¼" Diameter x 3¾" Height, Handle: 6¼"	EACH	10.58	1	6	0.67
ALSKSS002	2.6mm - 2¼ qt - 8¼" Diameter x 4" Height, Handle: 6¼"	EACH	12.57	1	6	0.89
ALSKSS003	2.6mm - 3¼ qt - 9" Diameter x 4¾" Height, Handle: 7½"	EACH	13.66	1	6	1.09
ALSKSS004	2.6mm - 4½ qt - 9¾" Diameter x 5" Height, Handle: 7½"	EACH	14.77	1	6	1.15
ALSKSS005	2.6mm - 5½ qt - 10¼" Diameter x 5½" Height, Handle: 7½"	EACH	16.53	1	6	1.67
ALSKSS006	2.6mm - 7 qt - 10¾" Diameter x 5¾" Height, Handle: 9¾"	EACH	17.20	1	6	1.97
ALSKSS007	2.6mm - 8½ qt - 11½" Diameter x 5½" Height, Handle: 10"	EACH	19.84	1	6	2.85
ALSKSS008	2.6mm - 10 qt - 12¾" Diameter x 5¾" Height, Handle: 10"	EACH	22.05	1	6	3.25
Lids						
ALSKSS101	1mm - 1½ qt - 6¾" Diameter x ¾" Thickness, Handle: 1"	EACH	5.06	1	6	0.22
ALSKSS102	1mm - 2¼ qt - 8½" Diameter x ¾" Thickness, Handle: 1"	EACH	5.95	1	6	0.38
ALSKSS103	1mm - 3¼ qt - 9¼" Diameter x ¾" Thickness, Handle: 1"	EACH	6.38	1	6	0.48
ALSKSS104	1mm - 4½ qt - 10" Diameter x ¾" Thickness, Handle: 1"	EACH	7.04	1	6	0.55
ALSKSS105	1.1mm - 5½ qt - 10¾" Diameter x ¾" Thickness, Handle: 1"	EACH	7.48	1	6	0.66
ALSKSS106	1.1mm - 7 qt - 11½" Diameter x ¾" Thickness, Handle: 1"	EACH	8.58	1	6	0.71
ALSKSS107	1.1mm - 8½ qt - 12¼" Diameter x ¾" Thickness, Handle: 1½"	EACH	9.02	1	6	0.83
ALSKSS108	1.1mm - 10 qt - 13" Diameter x ¾" Thickness, Handle: 1½"	EACH	9.90	1	6	0.95

ALUMINUM FRYER SAUCE PAN

Mirror finish. Extended stem catcher bolted on to hold fry baskets.
Note: ALSF001 and ALSF002 compatible with SLFB002. ALSF003 fits SLFB001

Fryer Sauce Pan
ALSF001 ~ ALSF003



ITEM	DESCRIPTION	U/M	WEIGHT GROSS lbs	INNER PACK	MASTER PACK	CU. FT.
ALSF001	Compatible with SLFB002 5.5 qt - 10½" Diameter x 5¾" Height, 7¾" Handle, 3¾" Stem	EACH	22.50	1	10	2.97
ALSF002	Compatible with SLFB002 7 qt - 10½" Diameter x 5¾" Height, 9¾" Handle, 3¾" Stem	EACH	24.50	1	8	3.14
ALSF003	Compatible with SLFB001 10 qt - 11¾" Diameter x 6½" Height, 9¾" Handle, 4" Stem	EACH	23.00	1	6	3.76

ALUMINUM DOUBLE BOILER

The heavy-gauge mirror-finished surface withstands heavy use in the kitchen. Top fits snug to properly cook delicate sauces or soups.

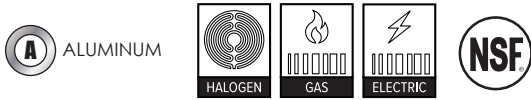

ITEM	DESCRIPTION	U/M	WEIGHT GROSS lbs	INNER PACK	MASTER PACK	CU. FT.
ALSKDB001	8 qt, 9½" Diameter x 7½" Height, ⅛" Thickness, Handle: 1⅝", Middle: 8½" Diameter x 8" Height, Lid: 10¼" Diameter x ⅝" Height	SET	6.82	1	1	0.86
ALSKDB002	12 qt, 10¼" Diameter x 9½" Height, ⅛" Thickness, Handle: 1¾", Middle: 9¼" Diameter x 9¼" Height, Lid: 11½" Diameter x ⅝" Height	SET	8.58	1	1	1.15
ALSKDB003	16 qt, 11⅜" Diameter x 10¼" Height, ⅛" Thickness, Handle: 1¾", Middle: 10⅜" Diameter x 9¼" Height, Lid: 12⅝" Diameter x ⅝" Height	SET	9.49	1	1	1.29
ALSKDB004	20 qt, 12¼" Diameter x 11" Height, ⅛" Thickness, Handle: 1⅝", Middle: 11¼" Diameter x 9¾" Height, Lid: 13" Diameter x ⅝" Height	SET	11.00	1	1	1.51



Double Boiler Set
ALSKDB001~ ALSKDB004

ALUMINUM TURKEY POT

Durable mirror-finished, with base strainer/rack, poultry hanger, and lid.



ITEM	DESCRIPTION	U/M	WEIGHT GROSS lbs	INNER PACK	MASTER PACK	CU. FT.
ALSKTP012	26 qt, 11¾" Diameter x 16" Height, Handle: 1¾", Lid: 11¾" x 1" Height, Handle: 1/2", Base Strainer: 9¼" Diameter x 13⅝" Height, Wire Rack Thickness: ¼", Poultry Hanger: 9½" Length x 9" Height, Wire Thickness: ¼"	SET	4.41	1	1	1.75



Turkey Pot
ALSKTP012

ANODIZED NON-STICK COATED SAUCE PAN

Avoid sticky mess and hassles with anodized non-stick coated sauce pan, featuring chrome plated steel cool handle.



ITEM	DESCRIPTION	U/M	WEIGHT GROSS lbs	INNER PACK	MASTER PACK	CU. FT.
ALSS010AC	1 qt, 6" Diameter x 2⅞" Height, 6⅞" Length x 1⅝" Width Handle	EACH	7.05	1	4	0.77
ALSS030AC	3 qt, 8⅝" Diameter x 3⅞" Height, 7⅞" Length x 1⅝" Width Handle	EACH	12.68	1	4	1.74
ALSS050AC	5 qt, 9¾" Diameter x 4⅞" Height, 9⅞" Length x 1¼" Width Handle	EACH	18.74	1	4	2.88



ALSS030AC
ALSS010AC
Non-Stick
Sauce Pans



Non-Stick Quantum 2 Fry Pan
ALFPEX001C ~ ALFPEX005C

Durable riveted handle.



→ ←
2.8 ~ 3.5 mm
Wall Thickness

ALUMINUM ALLOY FRY PAN

Avoids sticky mess and hassles with these reinforced professional **Quantum 2®** coated fry pans. Made of heavy duty aluminum alloy and durable riveted handle.



ITEM	DESCRIPTION	U/M	WEIGHT GROSS lbs	INNER PACK	MASTER PACK	CU. FT.
ALFPEX001C	7" Diameter x 1 1/8" Height, 5 1/2" Length x 1" Width Handle	EACH	7.70	1	6	0.36
ALFPEX002C	8" Diameter x 1 3/4" Height, 6 1/4" Length x 7/8" Width Handle	EACH	9.91	1	6	0.57
ALFPEX003C	10" Diameter x 2" Height, 7 3/8" Length x 7/8" Width Handle	EACH	15.43	1	6	0.88
ALFPEX004C	12" Diameter x 2 1/8" Height, 9 7/8" Length x 1 1/8" Width Handle	EACH	22.03	1	6	1.36
ALFPEX005C	14" Diameter x 2 1/2" Height, 11 3/4" Length x 1 1/8" Width Handle	EACH	26.90	1	6	1.91

**** With 3 layer Quantum 2 non-stick coating.**

ALUMINUM ALLOY FRY PAN

Made of heavy duty aluminum alloy and durable riveted handle. Available in brushed aluminum interior surface and 2 layer non-stick coating.



Fry Pan
ALSKFP001C ~ ALSKFP005C



Non-Stick Fry Pan
ALSKFP101C ~ ALSKFP105C

→ ←
2.8 ~ 3.5 mm
Wall Thickness

ITEM	DESCRIPTION	U/M	WEIGHT GROSS lbs	INNER PACK	MASTER PACK	CU. FT.
Natural						
ALSKFP001C	7" Diameter x 1 1/8" Height, 5 1/2" Length x 1" Width Handle	EACH	8.80	1	6	0.36
ALSKFP002C	8" Diameter x 1 3/4" Height, 6 1/4" Length x 7/8" Width Handle	EACH	9.91	1	6	0.57
ALSKFP003C	10" Diameter x 1 1/8" Height, 7 3/8" Length x 7/8" Width Handle	EACH	14.00	1	6	0.88
ALSKFP004C	12" Diameter x 2 1/8" Height, 9 7/8" Length x 1 1/8" Width Handle	EACH	22.03	1	6	1.36
ALSKFP005C	14" Diameter x 2 1/2" Height, 11 3/4" Length x 1 1/8" Width Handle	EACH	29.10	1	6	1.91

**** With brushed aluminum interior (Non-Stick)**

ALSKFP101C	7" Diameter x 1 1/8" Height, 5 1/2" Length x 1" Width Handle	EACH	8.81	1	6	0.36
ALSKFP102C	8" Diameter x 1 3/4" Height, 6 1/4" Length x 7/8" Width Handle	EACH	9.91	1	6	0.57
ALSKFP103C	10" Diameter x 2" Height, 7 3/8" Length x 7/8" Width Handle	EACH	15.42	1	6	0.88
ALSKFP104C	12" Diameter x 2" Height, 9 7/8" Length x 1 1/8" Width Handle	EACH	22.03	1	6	1.36
ALSKFP105C	14" Diameter x 2 1/2" Height, 11 3/4" Length x 1 1/8" Width Handle	EACH	29.10	1	6	1.91

**** With 2 layer non-stick coating.**

HEAT RESISTANT SILICONE COOL HANDLE

Use as extra precaution when handling hot cookware. Black color. Handle comes with hook piercing. Reusable and interchangeable. Easy to wash. Operating temperature from -5° C to 180° C.



Cool Handle
PLTWRH078C
PLTWRH112C
PLTWRH114C

ITEM	DESCRIPTION	U/M	WEIGHT GROSS lbs	INNER PACK	MASTER PACK	CU. FT.
Silicone Cool Handle						
PLTWRH078C	Fits 7" & 8" - 4 5/8" x 1 1/4" x 1/2"	EACH	9.00	12	120	0.42
PLTWRH112C	Fits 10" - 4 5/8" x 1 1/4" x 1/2"	EACH	14.00	12	120	0.56
PLTWRH114C	Fits 12" & 14" - 4 5/8" x 1 1/4" x 1/2"	EACH	18.00	12	120	0.86

FRY BASKETS (NICKEL PLATED)

Rectangular baskets fit slimly into the fryer for compact use. Open handle is angled to rest extended on fryer or be hooked on edge.

ITEM	DESCRIPTION	BASKET SIZE	U/M	WEIGHT GROSS lbs	INNER PACK	MASTER PACK	CU. FT.
Round with Cross Support Under							
SLFB001	Fits ALSF003 - Hook: 1 3/8", Handle: 7 3/8" 1 1/2"	11 1/2" Diameter x 5 3/8"	EACH	41.01	1	20	3.42
SLFB002	Fits ALSF002 - Hook: 3/4", Handle: 7 3/8" 1 1/2"	9 1/2" Diameter x 5"	EACH	30.35	1	20	2.38
SLFB003	Fits ALSF001 - Hook: 1 1/8", Handle: 7 1/4" 1 3/8"	8 3/4" Diameter x 5"	EACH	27.65	1	20	2.05
SLFB006	Round Fry Basket - Hook: 1 1/8", Handle: 7 1/4" 1 3/8"	13" Diameter x 5 3/8"	EACH	65.04	1	20	6.23
Rectangular with Cross Support Under							
SLFB004	Green Handle - Open Handle Hook: 3" x 1", Handle: 11 3/8", Height: 2 3/8"	13" x 6 3/8" x 5 3/8"	EACH	28.66	1	12	3.35
SLFB005	Blue Handle - Open Handle Hook: 3" x 3/4", Handle: 10 1/2", Height: 3 3/8"	13 3/8" x 5 3/4" x 5 1/2"	EACH	30.86	1	12	3.81
SLFB007	Gray Handle - Open Handle Hook: 2 3/8" x 3/4", Handle: 9 3/8", Height: 4"	13 1/2" x 4 1/4" x 5 1/2"	EACH	29.98	1	12	3.14
SLFB008	Orange Handle - Open Handle Hook: 3 3/8" x 3/4", Handle: 10 1/4", Height: 3 3/4"	12 1/8" x 6 1/4" x 5 1/4"	EACH	29.01	1	12	3.73
SLFB009	Yellow Handle - Open Handle Hook: 3 3/4" x 7/8", Handle: 12 1/4", Height: 1 3/4"	17" x 8" x 6 3/4"	EACH	21.58	1	6	3.75

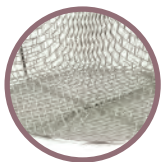

Cross Support

SLFB001
SLFB002
SLFB003
SLFB006



SLFB004



SLFB005



SLFB007

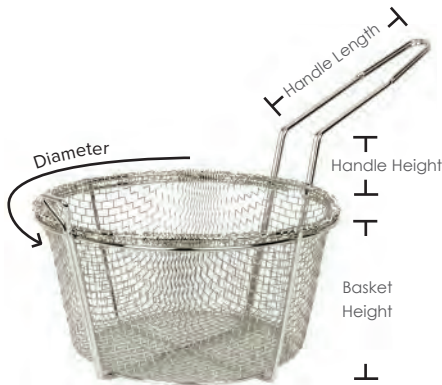

SLFB008



SLFB009



FRY BASKET PRESS (NICKEL PLATED)

Ensures efficient frying with flat mesh panel press. Elongated arm extends over fry basket for easy reaching. Available in different surface areas for specific usage.

ITEM	DESCRIPTION	U/M	WEIGHT GROSS lbs	INNER PACK	MASTER PACK	CU. FT.
SLFBP010	Green Handle 4 3/4" x 11" Fits SLFB004 & SLFB005	EACH	33.07	1	40	1.74
SLFBP014	Blue Handle 5 3/4" x 14 1/2"	EACH	57.00	1	30	1.43

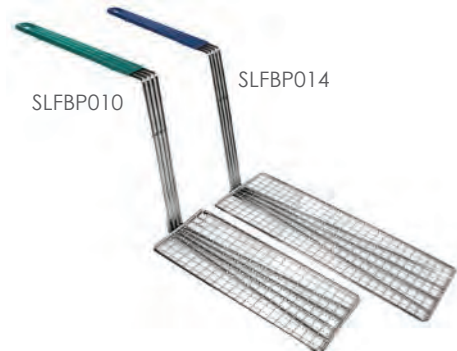

TABLE TOP SERVICES



GLTWSS002

MUSHROOM CAP SQUARE SHAKER

A rectangle glass body, complemented by a mushroom cap lid. Ideal for various spice storage in the kitchen or on the table.

ITEM	DESCRIPTION	U/M	WEIGHT GROSS lbs	INNER PACK	MASTER PACK	CU. FT.
GLTWSS002	2 oz, 1 1/2" Diameter x 4" Height	DOZEN	35.20	2	12	1.40



GLTWPS001



GLTWPS002



GLTWSS003

PANELED SHAKER

Glass paneled shakers with stainless steel lids. A cozy touch to any table setting.

ITEM	DESCRIPTION	U/M	WEIGHT GROSS lbs	INNER PACK	MASTER PACK	CU. FT.
GLTWPS001	1 oz, 1 1/2" Diameter x 2 3/4" Height	DOZEN	44.88	2	24	1.65
GLTWPS002	1 oz, 1 5/8" Diameter x 3" Height, Mushroom Cap	DOZEN	39.60	2	24	2.00
GLTWSS003	3 oz, 1 3/8" (Diameter Top) 2 1/8" Diameter x 4 1/2" Height	DOZEN	45.64	1.00	12	2.77



GLTWCS006



GLTWCS006P



PLTWCS006 (Polycarbonate)

SWIRL CHEESE SHAKER

Stores cheese powder in convenient and easy-to-identify clear glass shakers. Lids available in stainless steel slotted or perforated. Holds 6 oz of cheese powder ready for table use.

ITEM	DESCRIPTION	U/M	WEIGHT GROSS lbs	INNER PACK	MASTER PACK	CU. Ft.
Slotted						
GLTWCS006	6 oz, 2 3/4" Diameter x 3 1/2" Height Stainless Steel	DOZEN	44.09	1	8	2.53
Perforated						
GLTWCS006P	6 oz, 2 3/4" Diameter x 3 1/2" Height Stainless Steel	DOZEN	44.09	1	8	2.53
PLTWCS006	6 oz, 2 3/4" Diameter x 3 1/2" Height S/S Perforated Swirl Polycarbonate	DOZEN	16.54	1	12	2.30



GLTWCC205



GLTWCC005

CUBE SALT & PEPPER SHAKER

A convenient addition to any cozy table setting.

ITEM	DESCRIPTION	U/M	WEIGHT GROSS lbs	INNER PACK	MASTER PACK	CU. Ft.
GLTWCC005	1/2 oz, 1 1/2" x 1 1/2" x 3" Stainless Steel Top	DOZEN	46.30	4	48	2.10
GLTWCC205	1/2 oz, 1 1/2" x 1 1/2" x 3" Gold Top	DOZEN	46.30	4	48	2.10



GLTWTS001



GLTWTS201

TOWER SHAKER

A slim accent to salt and pepper on the table.

ITEM	DESCRIPTION	U/M	WEIGHT GROSS lbs	INNER PACK	MASTER PACK	CU. Ft.
GLTWTS001	1 oz, 1 7/8" Diameter x 4 1/4" Height Hole: 1.5mm, Stainless Steel Top	DOZEN	34.39	2	12	2.60
GLTWTS201	1 oz, 1 7/8" Diameter x 4 3/8" Height Hole: 1.5mm, Gold Top	DOZEN	34.39	2	12	2.60

OIL & VINEGAR CRUET

Square glass bottle with elongated neck. Easy to refill and clean.

ITEM	DESCRIPTION	U/M	WEIGHT GROSS lbs	INNER PACK	MASTER PACK	CU. FT.
GLTWOC006	6 oz Stainless Steel Top 2½" x 2½" x 5½" Height	DOZEN	35.27	1	6	2.20
GLTWOC206	6 oz Gold Top 2½" x 2½" x 5½" Height	DOZEN	35.27	1	6	2.20



SYRUP DISPENSER

Glass dispenser with cast zinc top that easily opens to pour syrups, juices, dressings and milk. Easy to clean and refill. Open handle made for quick use.

ITEM	DESCRIPTION	U/M	WEIGHT GROSS lbs	INNER PACK	MASTER PACK	CU. FT.
GLTWSY006	6 oz, 2¾" Diameter x 4½" Height	DOZEN	35.27	2	8	2.87
GLTWSY014	14 oz, 3¾" Diameter x 5¾" Height	DOZEN	30.86	1	2	1.72



SUGAR/CHEESE DISPENSER

Attractive fluted glass dispensers with stainless steel perforated, flip, or center holed caps. Ideal for holding sugar and cheese. Easy to refill and clean.

ITEM	DESCRIPTION	U/M	WEIGHT GROSS lbs	INNER PACK	MASTER PACK	CU. FT.
GLTWSJ012	12 oz, Flip Cap Top 3" Diameter x 5½" Height	DOZEN	42.99	2	4	2.41
GLTWSJ012H	12 oz, Single Hole Top 3" Diameter x 5½" Height	DOZEN	41.89	2	4	2.20
GLTWSJ012P	12 oz, Perforated Top 3" Diameter x 5½" Height	DOZEN	41.89	2	4	2.20



ACRYLIC STIRRER, STRAW & TOOTHPICK DISPENSER

Crystal clear acrylic dispenser with easy lift top for refills. Rectangular shapes nestles perfectly on counter-top corners. For containing and safely dispensing stirrers, straws, & toothpicks.

Made in Taiwan

ITEM	DESCRIPTION	U/M	WEIGHT GROSS lbs	INNER PACK	MASTER PACK	CU. FT.
PLSD001	7¾" x 4½" x 5¾"	EACH	17.60	1	12	1.75
PLSD002	12¾" x 5¾" x 6¾"	EACH	21.83	1	6	2.50
PLTD003	3¾" x 3¾" x 4¾"	EACH	32.12	1	36	2.50

PLSD001
Stirrer
Dispenser



PLTD003
Toothpick
Dispenser



PLSD002
Straw
Dispenser



STAINLESS STEEL NAPKIN DISPENSER

Stands upright on table tops and counter tops for fast and easy use. Easy to refill and keeps napkins organized.



ITEM	DESCRIPTION	U/M	WEIGHT GROSS lbs	INNER PACK	MASTER PACK	CU. FT.
SLNH001	3¾" x 4½" x 7½" Napkin Dispenser - Tall	EACH	41.89	1	36	3.14
SLNH002	3¾" x 4½" x 5¾" Napkin Dispenser - Short	EACH	30.86	1	36	2.49

SLNH001



SLNH002



PLTN4025

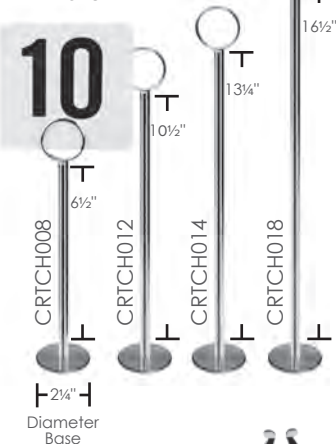

CHROME TABLE CARD STAND & NUMBER CARDS

Present cards on a balanced chrome plated card holder.

ITEM	DESCRIPTION	U/M	WEIGHT GROSS lbs	INNER PACK	MASTER PACK	CU. FT.
Table Card Stands						
CRTCH008	8" - 2 1/4" Diameter Base, 6 1/2" Pole Length, 1 1/4" Diameter Ring	EACH	35.20	12	120	1.40
CRTCH012	12" - 2 1/4" Diameter Base, 10 1/2" Pole Length, 1 1/4" Diameter Ring	EACH	40.00	12	120	1.98
CRTCH014	14 1/2" - 2 1/4" Diameter Base, 13 3/4" Pole Length, 1 1/4" Diameter Ring	EACH	44.09	12	120	2.37
CRTCH018	18" - 2 1/4" Diameter Base, 16 1/2" Pole Length, 1 1/4" Diameter Ring	EACH	48.50	12	120	2.95
Plastic Table Numbers 4" x 4"						
PLTN4025	Number 1~25	PACK	38.00	20	200	0.71
PLTN4050	Number 1~50	PACK	38.00	10	100	0.86
PLTN4100	Number 1~100	PACK	37.50	1	50	0.75

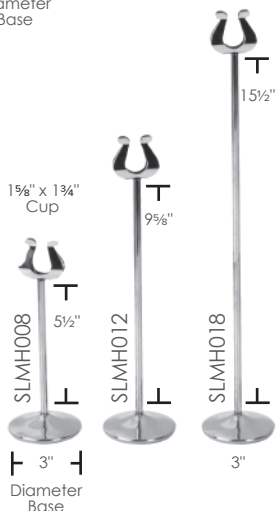

TABLE CARD STAND

Slim rod on a heavy base.



ITEM	DESCRIPTION	U/M	WEIGHT GROSS lbs	INNER PACK	MASTER PACK	CU. FT.
SLMH008	8" Overall Length, 3" Diameter Base, 5 1/2" Pole Length, 1 5/8" x 1 3/4" Cup	DOZEN	50.71	1	8	2.73
SLMH012	12" Overall Length, 3" Diameter Base, 9 5/8" Pole Length, 1 5/8" x 1 3/4" Cup	DOZEN	37.48	1	5	2.49
SLMH018	18" Overall Length, 3" Diameter Base, 15 1/2" Pole Length, 1 5/8" x 1 3/4" Cup	DOZEN	39.68	1	4	2.89

SLCJH004



CONDIMENT JAR, SALT & PEPPER/SUGAR PACKET HOLDER

ITEM	DESCRIPTION	U/M	WEIGHT GROSS lbs	INNER PACK	MASTER PACK	CU. FT.
Stainless Steel Holder						
SLCJH002	2 Holes, 6 3/8" x 3 3/8" x 7 7/8" Hole Size: 3 3/8" Diameter	EACH	24.20	12	72	3.68
SLCJH003	3 Holes, 7 1/8" x 6" x 8" Hole Size: 3 3/8" Diameter	EACH	22.05	12	48	5.74
SLCJH004	4 Holes, 6 7/8" x 6 1/8" x 7 1/2" Hole Size: 3 3/8" Diameter	EACH	26.46	12	48	5.61

** Holder, Jar, Cover sold separately **

Jar & Cover

CRSP435



GLCJ007	7 oz Glass Jar 3 1/8" Diameter x 2 7/8" Height	EACH	30.80	48	48	1.10
PLCJ007	7 oz Plastic Jar w/Cover 3" Diameter x 3 3/8" Height	EACH	14.30	12	96	2.11
PLCJ007C	3" Diameter x 3/4" Height, Condiment Cover fits PLCJ007	EACH	14.11	12	300	1.07
SLCJ007C	3 3/8" Diameter x 3/4" Height, Condiment Cover fits SLCJ007	EACH	20.94	24	144	0.92

CRSP956



Sugar Packet Holder

CRSP435	Sugar Packet Holder 4 1/2" x 3 1/2" x 5 1/2"	EACH	18.08	12	48	1.86
CRSP956	Salt & Pepper / Sugar Packet Holder 9" x 5" x 5 1/4"	EACH	24.56	12	48	3.99

SUGAR PACKET HOLDER



PLSP032BK



PLSP032CH



PLSP032CL



PLSP032WT

ITEM	DESCRIPTION	U/M	WEIGHT GROSS lbs	INNER PACK	MASTER PACK	CU. FT.
PLSP032BK	Black, 3½" x 2½" x 2"	DOZEN	16.53	2	10	1.22
PLSP032CH	Brown, 3½" x 2½" x 2"	DOZEN	16.53	2	10	1.22
PLSP032CL	Clear, 3½" x 2½" x 2"	DOZEN	16.53	2	10	1.22
PLSP032WT	White, 3½" x 2½" x 2"	DOZEN	16.53	2	10	1.22

MENU HOLDER

Perfect for displaying menus, business cards, and other information cards.



SLTWMH004



SLTWMH006



SLMH001



SLMH002



SLRMH003

ITEM	DESCRIPTION	U/M	WEIGHT GROSS lbs	INNER PACK	MASTER PACK	CU. FT.
SLTWMH004	2½" Diameter x 2" Height, Ring Shape	EACH	29.70	72	720	2.68
SLTWMH006	2½" Diameter x 2½" Height,	EACH	31.90	72	720	2.68
SLMH001	1" Diameter x 1½" Height, Harp Shape	EACH	37.00	120	720	0.62
SLMH002	2¼" Diameter x 2" Height, Ring Shape	EACH	30.90	24	288	1.18
SLRMH003	2¼" Diameter x 2¼" Height, Ring Shape	EACH	23.10	24	240	1.32

PLASTIC TABLE CARD HOLDER

Acrylic table card holders with sturdy flat plane insert perpendicular to flat base.

Made in Taiwan

ITEM	DESCRIPTION	U/M	WEIGHT GROSS lbs	INNER PACK	MASTER PACK	CU. FT.
PLMH001	5½" x 3½", 2 mm Thickness	EACH	18.30	12	72	1.70
PLMH002	4" x 6", 2 mm Thickness	EACH	20.24	12	72	1.79
PLMH003	5" x 7", 2 mm Thickness	EACH	18.74	12	48	1.80
PLMH004	8½" x 11", 2 mm Thickness	EACH	28.22	6	24	2.30



MENU COVER

Protects papers with a flexible plastic laminate folder.



PLMENU-L3BL



ITEM	DESCRIPTION	U/M	WEIGHT GROSS lbs	INNER PACK	MASTER PACK	CU. FT.
3 Page Book Fold						
PLMENU-L3BL	8½" x 11" - Black	EACH	22.05	10	50	1.22
PLMENU-L3BR	8½" x 11" - Brown	EACH	22.05	10	50	1.22
PLMENU-L3GR	8½" x 11" - Green	EACH	22.05	10	50	1.22
PLMENU-L3MA	8½" x 11" - Maroon	EACH	22.05	10	50	1.22



PLMENU-L4MA

ITEM	DESCRIPTION	U/M	WEIGHT GROSS lbs	INNER PACK	MASTER PACK	CU. FT.
4 Page Book Fold						
PLMENU-L4BL	8½" x 11" - Black	EACH	28.66	10	50	1.61
PLMENU-L4BR	8½" x 11" - Brown	EACH	28.66	10	50	1.61
PLMENU-L4GR	8½" x 11" - Green	EACH	28.66	10	50	1.61
PLMENU-L4MA	8½" x 11" - Maroon	EACH	28.66	10	50	1.61
PLMENU-4	8½" x 14" - Black (long)	EACH	35.27	10	50	1.26
PLMENU-4BR	8½" x 14" - Brown (long)	EACH	35.27	10	50	1.26



PLMENU-6GR

ITEM	DESCRIPTION	U/M	WEIGHT GROSS lbs	INNER PACK	MASTER PACK	CU. FT.
6 Page Book Fold						
PLMENU-6TGI	7½" x 13¼" - Black (long)	EACH	46.96	10	50	3.77
PLMENU-6BL	8½" x 11" - Black	EACH	45.20	10	50	3.08
PLMENU-6BR	8½" x 11" - Brown	EACH	45.20	10	50	3.08
PLMENU-6GR	8½" x 11" - Green	EACH	45.20	10	50	3.08
PLMENU-6MA	8½" x 11" - Maroon	EACH	45.20	10	50	3.08

ITEM	DESCRIPTION	U/M	WEIGHT GROSS lbs	INNER PACK	MASTER PACK	CU. FT.
Single Menu Cover						
PLMENU-1BL	8½" x 11" - Black	EACH	8.82	10	50	0.44
PLMENU-1BR	8½" x 11" - Brown	EACH	8.82	10	50	0.44
PLMENU-1GR	8½" x 11" - Green	EACH	8.82	10	50	0.44
PLMENU-1MA	8½" x 11" - Maroon	EACH	8.82	10	50	0.44



PLMENU-1GR

ITEM	DESCRIPTION	U/M	WEIGHT GROSS lbs	INNER PACK	MASTER PACK	CU. FT.
Double Fold Menu Cover						
PLMENU-2BL	8½" x 11" - Black	EACH	15.43	10	50	0.84
PLMENU-2BR	8½" x 11" - Brown	EACH	15.43	10	50	0.84
PLMENU-2GR	8½" x 11" - Green	EACH	15.43	10	50	0.84
PLMENU-2MA	8½" x 11" - Maroon	EACH	15.43	10	50	0.84



PLMENU-2GR

ITEM	DESCRIPTION	U/M	WEIGHT GROSS lbs	INNER PACK	MASTER PACK	CU. FT.
Triple Fold Menu Cover						
PLMENU-3BL	8½" x 11" - Black	EACH	22.05	10	50	1.25
PLMENU-3BR	8½" x 11" - Brown	EACH	22.05	10	50	1.25
PLMENU-3GR	8½" x 11" - Green	EACH	22.05	10	50	1.25
PLMENU-3MA	8½" x 11" - Maroon	EACH	22.05	10	50	1.25



PLMENU-3GR

CHECK PRESENTATION COVER

Black or brown cover with pocket inserts to hold checks, cash, and credit cards. "Thank You" wording is imprinted in gold color on the front cover.

ITEM	DESCRIPTION	U/M	WEIGHT GROSS lbs	INNER PACK	MASTER PACK	CU. FT.
PCPC-1BL	5¾" x 9½" - Black	EACH	17.64	10	50	1.28
PCPC-1BR	5¾" x 9½" - Brown	EACH	17.64	10	50	1.28



PCPC-1BL



PCPC-1BR



PLPT046BL



PLPT046BR

PLASTIC TIP TRAY

"Thank You" wording imprinted in gold color. Can be used with Check Presentation Cover.

ITEM	DESCRIPTION	U/M	WEIGHT GROSS lbs	INNER PACK	MASTER PACK	CU. FT.
PLPT046BL	4½" x 6½" x ¼" - Black	DOZEN	37.80	4	24	1.24
PLPT046BR	4½" x 6½" x ¼" - Brown	DOZEN	37.80	4	24	1.24

NO CLIP CHECK HOLDER

Displays paper slips in an orderly arranged manner, without clips.

Made in Taiwan



SLTWCH018

ITEM	DESCRIPTION	U/M	WEIGHT GROSS lbs	INNER PACK	MASTER PACK	CU. FT.
SLTWCH018	18" x 3½" x ¾"	EACH	54.01	12	48	1.20
SLTWCH024	24" x 3½" x ¾"	EACH	37.00	12	24	0.80
SLTWCH030	30" x 3½" x ¾"	EACH	44.00	12	24	1.00
SLTWCH036	36" x 3½" x ¾"	EACH	52.14	12	24	1.15
SLTWCH044	44" x 3½" x ¾"	EACH	63.80	12	24	1.47

CHECK SPINDLE

Tri-pod circular base with stem. Gold finish.



SLSPIN001

ITEM	DESCRIPTION	U/M	WEIGHT GROSS lbs	INNER PACK	MASTER PACK	CU. FT.
SLSPIN001	3½" Diameter x 6" Height	EACH	31.53	12	240	3.20

TABLE BELL

For a quick alert at the desk or at the counter.



SLBELL001

ITEM	DESCRIPTION	U/M	WEIGHT GROSS lbs	INNER PACK	MASTER PACK	CU. FT.
SLBELL001	3¾" Diameter x 2¼" Height	EACH	41.89	12	144	3.05

GRAVY BOAT

Mirror finish. Tapered spout helps prevent dripping. Contoured handle, securely welded to the base for easy pouring.



SLGB003 ~ SLGB008

ITEM	DESCRIPTION	U/M	WEIGHT GROSS lbs	INNER PACK	MASTER PACK	CU. FT.
SLGB003	3 oz, 5½" x 2½" x 3"	EACH	11.23	6	48	0.95
SLGB005	5 oz, 7½" x 3" x 2¾"	EACH	15.43	6	48	1.45
SLGB008	8 oz, 8¼" x 3½" x 3¼"	EACH	22.05	6	48	2.32

SYRUP PITCHER

Clear plastic syrup pitcher with paneled surface. Easy to clean and reusable.

ITEM	DESCRIPTION	U/M	WEIGHT GROSS lbs	INNER PACK	MASTER PACK	CU. FT.
PLSP002D	2 oz, 2¼" Diameter x 2" Height	DOZEN	40.12	9	54	2.60



PLSP002D

SAUCE CUP



ITEM	DESCRIPTION	U/M	WEIGHT GROSS lbs	INNER PACK	MASTER PACK	CU. FT.
SLSA001	1½ oz, 2¾" Diameter x 1" Height	EACH	29.10	12	576	0.83
SLSA002	2½ oz, 2½" Diameter x 1½" Height	EACH	36.70	12	576	0.94
SLSA003	3 oz, 2¾" Diameter x 1½" Height	EACH	25.37	12	288	0.57
SLSA004	4 oz, 2¾" Diameter x 2" Height	EACH	27.57	12	288	0.68



SLSA001



SLSA002



SLSA003



SLSA004

RAMEKIN, BONE

ITEM	DESCRIPTION	U/M	WEIGHT GROSS lbs	INNER PACK	MASTER PACK	CU. FT.
PLRM005W	5 oz, Fluted, Bone, 3½" Diameter x 1½" Height ABS	DOZEN	46.74	4	36	2.84



PLRM005W

EGG CUP

Perfect for any restaurant that is looking for a way to display and hold a perfectly cooked soft boiled egg.



ITEM	DESCRIPTION	U/M	WEIGHT GROSS lbs	INNER PACK	MASTER PACK	CU. FT.
SLEC001	2" x 2½" Height	EACH	21.03	12	288	1.84
SLEC002	2" x 1½" Height	EACH	16.98	12	288	1.45



SLEC001



SLEC002

FRY CUP

Serve your french fries, breadsticks, pretzels, or other snacks in style.



ITEM	DESCRIPTION	U/M	WEIGHT GROSS lbs	INNER PACK	MASTER PACK	CU. FT.
SLFFC001	13 oz, Satin 3¾" Diameter x 3¾" Height	EACH	17.66	12	48	0.46
SLFFC003	13 oz, Hammered 3¾" Diameter x 3¾" Height	EACH	17.77	12	48	0.46
SLFFC005	14 oz, Mirror, Angled 3½" Diameter x 4½" Height	EACH	19.78	12	48	0.58



SLFFC001



SLFFC003



SLFFC005

PIZZA STAND

Chrome plated wire pizza tray stand.

ITEM	DESCRIPTION	U/M	WEIGHT GROSS lbs	INNER PACK	MASTER PACK	CU. FT.
CRPTS997	Pizza Tray Stand 9½" x 9" x 6½"	EACH	33.07	12	24	1.34



CRPTS997



SLGT008 ~ SLGT120

↓ 0.63 ~ 0.7 mm
↑ Wall Thickness

OVAL AU GRATIN DISH

Oval stainless steel au gratin dish with a groove to hold in crumbs or toppings for an elegant presentation.



ITEM	DESCRIPTION	U/M	WEIGHT GROSS lbs	INNER PACK	MASTER PACK	CU. FT.
SLGT008	8 oz, 8" x 3 ⁷ / ₈ " x 1"	EACH	42.00	12	144	0.94
SLGT012	12 oz, 9 ¹ / ₄ " x 5" x 1"	EACH	48.00	12	144	1.40
SLGT020	20 oz, 10 ⁵ / ₈ " x 6 ¹ / ₂ " x 1 ¹ / ₄ "	EACH	35.27	12	72	0.85
SLGT108	8 oz, 7 ⁷ / ₈ " x 4 ³ / ₈ " x 1"	EACH	39.60	12	144	0.88
SLGT112	12 oz, 9" x 4 ³ / ₈ " x 1 ¹ / ₄ "	EACH	44.00	12	144	1.00
SLGT120	20 oz, 10 ⁷ / ₈ " x 6 ¹ / ₂ " x 1"	EACH	35.71	12	72	0.81



SLSSD003



SLSSD005

SHERBET DISH

Serve ice-cream, sherbet or any frozen desserts. Stands on a flat base with a mirror polish.



ITEM	DESCRIPTION	U/M	WEIGHT GROSS lbs	INNER PACK	MASTER PACK	CU. FT.
SLSSD003	3 ¹ / ₂ oz, 3 ³ / ₄ " Diameter x 1 ¹ / ₂ " Height	EACH	23.00	12	144	2.51
SLSSD005	5 oz, 4 ¹ / ₂ " x Diameter x 1 ⁵ / ₈ " Height	EACH	28.00	12	144	3.40



SLBW004

BUTTER WARMER SET

A 3 piece set with stainless steel base, warmer pan, and glass flame holder.

ITEM	DESCRIPTION	U/M	WEIGHT GROSS lbs	INNER PACK	MASTER PACK	CU. FT.
SLBW004	O/A: 3 ¹ / ₂ " Diameter x 5 ¹ / ₂ " Height Dish: 3 ¹ / ₂ " Diameter x 1" Height Glass Holder: Diameter x 2 ¹ / ₄ " Height	SET	45.19	1	48	2.78

COFFEE DECANTER

Open rimmed mirror finish stainless steel with black easy-grip handle.



SLRCD001



SLTCD024

SLTCD012

ITEM	DESCRIPTION	U/M	WEIGHT GROSS lbs	INNER PACK	MASTER PACK	CU. FT.
SLRCD001	64 oz Coffee Decanter 6" Diameter x 6 ⁵ / ₈ " Height, 1 ³ / ₈ " Handle Length	EACH	21.25	1	12	2.76
SLTCD012	12 oz Turkish Coffee Decanter 3 ¹ / ₂ " Diameter x 3 ¹ / ₂ " Height, 4 ³ / ₄ " Handle Length	EACH	12.13	6	24	1.08
SLTCD024	24 oz Turkish Coffee Decanter 4 ¹ / ₂ " Diameter x 4 ¹ / ₂ " Height, 5 ¹ / ₂ " Handle Length	EACH	16.50	6	24	1.72

WATER PITCHER with ICE GUARD

Added ice guard to prevent spilling of water and ice.



ITEM	DESCRIPTION	U/M	WEIGHT GROSS lbs	INNER PACK	MASTER PACK	CU. FT.
SLWP064	64 oz, 4¾" Diameter 7¾" Height, 4¼" Length x 2¼" Width Handle (1¾" Grip Space)	EACH	17.64	1	12	2.43
SLME266	66 oz, 5½" Diameter 6½" Height, 4¼" Length x 2¼" Width Handle (1¾" Grip Space)	EACH	44.09	1	24	3.99



SLWP064



SLME266

CREAMER

Creamer in mirror polished stainless steel.



ITEM	DESCRIPTION	U/M	WEIGHT GROSS lbs	INNER PACK	MASTER PACK	CU. FT.
SLFCR005	5 oz Footed Creamer w/ Lid 2½" Diameter x 3½" Height	EACH	40.75	12	144	3.90
Bell Creamer						
SLRBC001	3 oz, 1" Base Diameter x 2¼" Height, 2" Length x 1" Width Handle, 1½" Grip Space	EACH	18.00	12	144	1.59
SLRBC002	5 oz, 1¾" Base Diameter x 2½" Height, 1¾" Length x ¾" Width Handle, 1¾" Grip Space	EACH	26.00	12	144	2.07
SLRBC003	8 oz, 2½" Base Diameter x 3" Height, 1½" Length x ¾" Width Handle, 1½" Grip Space	EACH	33.00	12	144	3.29



SLFCR005



SLRBC001 ~ SLRBC003

MILK PITCHER

Milk pitcher in mirror polished stainless steel. Good for maintaining milk temperature, cold or hot.



ITEM	DESCRIPTION	U/M	WEIGHT GROSS lbs	INNER PACK	MASTER PACK	CU. FT.
Frothing						
SLME012	12 oz, 2¾" Base Diameter x 4½" Height, 2¾" Length x ⅝" Width Handle (1⅝" Hand Grip Space)	EACH	11.02	1	24	0.87
SLME020	20 oz, 3⅝" Base Diameter x 4½" Height, 2⅞" Length x 1¼" Width Handle (1⅝" Hand Grip Space)	EACH	17.64	1	24	1.37
SLME033	33 oz, 3⅝" Base Diameter x 5" Height, 3½" Length x ⅝" Width Handle (1⅝" Hand Grip Space)	EACH	22.05	1	24	1.85
SLME050	50 oz, 3¾" Base Diameter x 6½" Height, 4½" Length x ¾" Width Handle (1½" Hand Grip Space)	EACH	29.76	1	24	3.21
SLME066	66 oz, 5½" Base Diameter x 6¾" Height, 2½" Length x ¾" Width Handle (2" Hand Grip Space)	EACH	19.84	1	12	2.02
Espresso Engraved with measuring scale						
SLMP0018	18 oz, 3½" Base Diameter x 4½" Height, 2⅞" Length x ¾" Width Handle (1¼" Hand Grip Space)	EACH	17.99	1	24	1.29
SLMP0024	24 oz, 3⅝" Base Diameter x 4⅝" Height, 3⅝" Length x ¾" Width Handle (1¼" Hand Grip Spac)	EACH	22.00	1	24	1.88
SLMP0040	40 oz, 4¼" Base Diameter x 5½" Height, 3⅝" Length x ⅔" Width Handle (1½" Hand Grip Spac)	EACH	27.02	1	24	2.62

SLME012 ~ SLME066



SLMP0018 ~ SLMP0040





SLCF001



SLCF003
(Inner)



SLCF002
(Lid)



COFFEE DRIPPER

Stainless steel coffee maker with filter, inner part, and lid. Brews coffee without the need for electricity. Quick and efficient.



ITEM	DESCRIPTION	U/M	WEIGHT GROSS lbs	INNER PACK	MASTER PACK	CU. FT.
SLCF001	Coffee Drainer Set 3 3/4" Diameter x 2 1/2" Height	EACH	33.95	12	144	3.94
SLCF002	Lid Only 2 1/2" Diameter x 1/4" Thickness	EACH	34.10	1000	1000	1.03
SLCF003	Inner Part 2 1/4" Diameter x 1 1/2" Height	EACH	28.66	500	500	1.54

MILK SERVER



SLSR010TP



SLSR210



ITEM	DESCRIPTION	U/M	WEIGHT GROSS lbs	INNER PACK	MASTER PACK	CU. FT.
SLSR010TP	10 oz, 2 1/2" Diameter Base x 4 1/8" Height, 3 1/8" Length x 1/2" Width Handle (1 1/2" Grasp)	EACH	35.00	6	72	2.19
SLSR210	10 oz, 2 1/2" Diameter Base x 3 3/8" Height, 1 5/8" Length x 1/4" Width Handle (1 1/8" Grasp)	EACH	24.00	6	72	1.82

TEA BALL

With chain and mesh lining. Keeps tea leaves residue in the ball while extracting tea.



SLTB001 ~ SLTB004



SLTB006



SLTB005



ITEM	DESCRIPTION	U/M	WEIGHT GROSS lbs	INNER PACK	MASTER PACK	CU. FT.
SLTB001	2" Diameter x 1 3/8" Height	EACH	15.43	12	288	1.53
SLTB002	2 1/4" Diameter x 2 1/2" Height	EACH	26.40	12	288	3.30
SLTB003	3 1/8" Diameter x 2 5/8" Height	EACH	33.88	12	288	5.05
SLTB004	3 1/2" Diameter x 2 3/4" Height	EACH	38.58	12	288	6.77
SLTB005	4 3/8" Diameter x 4" Height	EACH	37.48	12	120	6.62
SLTB006	5 1/4" Diameter x 4 1/4" Height	EACH	13.75	1	36	2.81

DRIP TRAY



ALDT045



ALDT060

ITEM	DESCRIPTION	U/M	WEIGHT GROSS lbs	INNER PACK	MASTER PACK	CU. Ft.
ALDT045	4 1/2" x 4 1/2" x 5/8", Hexagon Drip Tray Pack of 4	PACK	12.60	12	24	1.06
ALDT060	5 1/2" x 5 1/2" x 5/8", Hexagon Drip Tray Pack of 4	PACK	16.50	12	24	1.77

TABLE TENT SIGN

3" x 1 1/2" Stainless steel tent sign displays.



ITEM	DESCRIPTION	U/M	WEIGHT GROSS lbs	INNER PACK	MASTER PACK	CU. Ft.
SLTS3151	Blank, 3" x 1 1/2" x 1 3/8"	EACH	19.40	24	240	0.12
SLTS3152	Hot Tea, 3" x 1 1/2" x 1 3/8"	EACH	19.40	24	240	0.12
SLTS3153	Decaf, 3" x 1 1/2" x 1 3/8"	EACH	19.40	24	240	0.12
SLTS3154	Coffee, 3" x 1 1/2" x 1 3/8"	EACH	19.40	24	240	0.12
SLTS3155	Hot Water, 3" x 1 1/2" x 1 3/8"	EACH	19.40	24	240	0.12
SLTS3156	Iced Tea, 3" x 1 1/2" x 1 3/8"	EACH	19.40	24	240	0.12

COFFEE DECANTER

64 oz. coffee decanter in a polycarbonate body on a stainless steel base for added support and more resistant to breakage. Durable plastic handles color coded in black for regular and orange for decaf.

Color Coded

ITEM	DESCRIPTION	U/M	WEIGHT GROSS lbs	INNER PACK	MASTER PACK	CU. FT.
PLCD064	64 oz, 4" Diameter Base x 7" Height, 4¼" Length x ¾" Width, (3⅛" Grip Space)	EACH	13.54	1	12	2.76
PLCD064D	64 oz, Decaf, 4" Diameter Base x 7" Height, 4¼" Length x ¾" Width, (3⅛" Grip Space)	EACH	13.54	1	12	2.76



PLCD064

Stainless Steel



PLCD064D

U-SHAPE BRUSH

Designed to clean coffee decanters. Brush features a curved shape that fits the curve of most standard decanters to help make it easier to clean.

ITEM	DESCRIPTION	U/M	WEIGHT GROSS lbs	INNER PACK	MASTER PACK	CU. FT.
PLCDB001	12¼" Overall, 4¾" x 6¼" Brush with 5½" x 1" Handle	EACH	19.80	12	96	2.85



PLCDB001

COFFEE KNOCK BOX

This box is designed for repeated hard knocks of a commercial operation. Flared top edges on this knock box makes it versatile on a counter top or recessed into a counter.

STAINLESS STEEL

ITEM	DESCRIPTION	U/M	WEIGHT GROSS lbs	INNER PACK	MASTER PACK	CU. FT.
SLKB164	6¾" x 6⅞" x 4", 0.6 mm Thickness	EACH	21.23	1	24	3.15
SLKB166	6¾" x 6⅞" x 6", 0.6 mm Thickness	EACH	28.63	1	24	4.72
PLKB001	Knock Bar for SLKB164 / SLKB166, ¾" Diameter x 5⅞"	EACH	5.66	12	96	0.34



SLKB166

SLKB164

PLKB001

DOUBLE WALL VACUUM SERVER

STAINLESS STEEL

ITEM	DESCRIPTION	U/M	WEIGHT GROSS lbs	INNER PACK	MASTER PACK	CU. FT.
TJWB007	0.7 Liter Black/Stainless Carafe	EACH	21.38	1	12	1.59
TJWB010	1 Liter Black/Stainless Carafe	EACH	23.15	1	12	2.03



TJWB007

TJWB010

CHAIN SIGN

3½" x 1⅜" - Hang chain signs over beverage container for easy content identification.

STAINLESS STEEL

ITEM	DESCRIPTION	U/M	WEIGHT GROSS lbs	INNER PACK	MASTER PACK	CU. FT.
SLCS3172	Hot Tea	EACH	19.40	24	240	0.12
SLCS3173	Decaf	EACH	19.40	24	240	0.12
SLCS3174	Coffee	EACH	19.40	24	240	0.12
SLCS3175	Hot Water	EACH	19.40	24	240	0.12
SLCS3176	Iced Tea	EACH	19.40	24	240	0.12

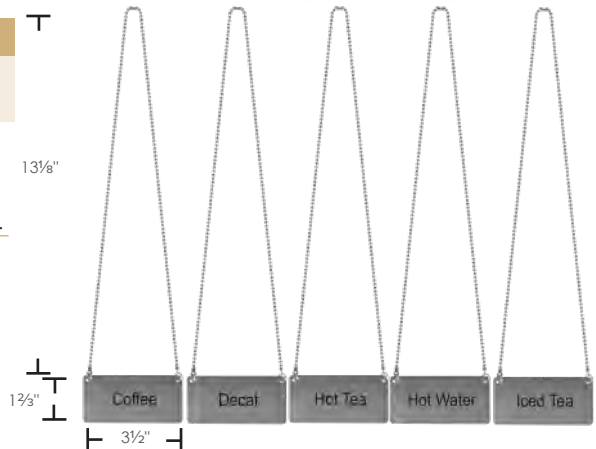

13⅞"

1⅜"

3½"

AIRPOTS

Made in Taiwan



6 1/4" Diameter



APLG022
APLG025



Decaf Variant

GLASS LINER/ PLASTIC EXTERIOR

ITEM	DESCRIPTION	U/M	WEIGHT GROSS lbs	INNER PACK	MASTER PACK	CU. FT.
Lever Top						
APLG022	2.2 Liter/ 74 oz	EACH	27.06	1	6	2.77
APLG022D	2.2 Liter/ 74 oz Decaf	EACH	27.06	1	6	2.77
APLG025	2.5 Liter/ 84 oz	EACH	29.04	1	6	2.92
APLG025D	2.5 Liter/ 84 oz, Decaf	EACH	29.04	1	6	2.92
Push Button						
APPG022	2.2 Liter/ 74 oz	EACH	27.06	1	6	2.77
APPG022D	2.2 Liter/ 74 oz, Decaf	EACH	27.06	1	6	2.77
APPG025	2.5 Liter/ 84 oz	EACH	29.04	1	6	2.92
APPG025D	2.5 Liter/ 84 oz, Decaf	EACH	29.04	1	6	2.92



GLASS LINER, STAINLESS STEEL EXTERIOR



ASLG322
ASLG325
ASLG330



3 ID Tags Included

ITEM	DESCRIPTION	U/M	WEIGHT GROSS lbs	INNER PACK	MASTER PACK	CU. FT.
Lever Top						
ASLG322	2.2 Liter/ 74 oz, 6 3/4" Diameter Base x 15 3/4" Overall Height	EACH	27.06	1	6	2.77
ASLG325	2.5 Liter/ 84 oz, 6 3/4" Diameter Base x 16 3/4" Overall Height	EACH	29.04	1	6	2.92
ASLG330	3.0 Liter/ 101 oz, 6 3/4" Diameter Base x 16 3/4" Overall Height	EACH	30.80	1	6	3.11
Push Button						
ASPG319	1.9 Liter/ 64 oz, 6 3/4" Diameter Base x 15 1/2" Overall Height	EACH	24.64	1	6	2.69
ASPG322	2.2 Liter/ 74 oz, 6 3/4" Diameter Base x 15 3/4" Overall Height	EACH	27.06	1	6	2.77
ASPG325	2.5 Liter/ 84 oz, 6 3/4" Diameter Base x 16 1/2" Overall Height	EACH	29.04	1	6	2.92
ASPG330	3.0 Liter/ 101 oz, 6 3/4" Diameter Base x 16 3/4" Overall Height	EACH	29.04	1	6	2.92



STAINLESS STEEL LINER & EXTERIOR



ASPS325
ASPS330



3 ID Tags Included

ITEM	DESCRIPTION	U/M	WEIGHT GROSS lbs	INNER PACK	MASTER PACK	CU. FT.
Lever Top						
ASLS325	2.5 Liter/ 84 oz, 6 1/2" Diameter Base x 15 1/2" Overall Height	EACH	32.56	1	6	2.77
ASLS330	3.0 Liter/ 101 oz, 6 1/2" Diameter Base x 16 1/2" Overall Height	EACH	35.86	1	6	2.92
Push Button						
ASPS325	2.5 Liter/ 84 oz, 6 1/2" Diameter Base redredx 15 1/2" Overall Height	EACH	32.56	1	6	2.77
ASPS330	3.0 Liter/ 101 oz 6 1/2" Diameter Base x 16 1/2" Overall Height	EACH	35.86	1	6	2.92



SWIRL DOUBLE WALL INSULATED BEVERAGE SERVER



PLWS020BK
PLWS042BK
PLWS064BK



PLWS020WT
PLWS042WT
PLWS064WT

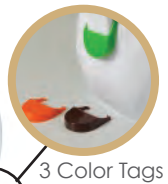

3 Color Tags

ITEM	DESCRIPTION	U/M	WEIGHT GROSS lbs	INNER PACK	MASTER PACK	CU. FT.
Black						
PLWS020BK	20 oz/0.6 Liter, Plastic, Black, 3 3/4" Diameter Base x 8 1/8" Height with 4 7/8" Length x 7/8" Width Handle (2" Grip space)	SET	25.00	1	24	3.68
PLWS020BKL	Replacement Lid For PLWS020BK, 2 3/4" Diameter x 1 3/4" Height with 1" Push Button	EACH	3.53	1	24	0.30
PLWS042BK	42 oz/1.24 Liter, Plastic, Black, 4" Diameter Base x 9 7/8" Height with 7" Length x 1" Width Handle (2 3/8" Grip space)	SET	22.00	1	12	3.40
PLWS042BKL	Replacement Lid For PLWS042BK, 3 1/2" Diameter x 2 1/4" Height with 1" Push Button	EACH	6.17	1	24	0.54
PLWS064BK	64 oz/1.9 Liter, Plastic, Black, 4 3/4" Diameter Base x 11 3/8" Height with 6" Length x 1" Width Handle (2 1/2" Grip space)	SET	17.00	1	6	2.41
PLWS064BKL	Replacement Lid For PLWS064BK, 4 3/8" Diameter x 2 1/2" Height with 1 1/4" Push Button	EACH	7.72	1	24	0.79
White						
PLWS020WT	20 oz/0.6 Liter, Plastic, White, 3 3/4" Diameter Base x 8 1/8" Height with 4 7/8" Length x 7/8" Width Handle (2" Grip space)	SET	25.00	1	24	3.68
PLWS020WTL	Replacement Lid For PLWS020WT, 2 3/4" Diameter x 1 3/4" Height with 1" Push Button	EACH	3.53	1	24	0.30
PLWS042WT	42 oz/1.24 Liter, Plastic, White, 4" Diameter Base x 9 7/8" Height with 7" Length x 1" Width Handle (2 3/8" Grip space)	SET	22.00	1	12	3.40
PLWS042WTL	Replacement Lid For PLWS042WT, 3 1/2" Diameter x 2 1/4" Height with 1" Push Button	EACH	6.17	1	24	0.54
PLWS064WT	64 oz/1.9 L, Plastic, White, 4 3/4" Diameter Base x 11 3/8" Height with 6" Length x 1" Width Handle (2 1/2" Grip space)	SET	17.00	1	6	2.41
PLWS064WTL	Replacement Lid For PLWS064WT, 4 3/8" Diameter x 2 1/2" Height with 1 1/4" Push Button	EACH	7.72	1	24	0.79

COFFEE SERVER

Coffee server keeps coffee hot and fresh for hours. Perfect for restaurants, hotels, or break rooms.



ASCS112
ASCS115
ASCS119



ASCS019BT



ASGD057

ITEM	DESCRIPTION	U/M	WEIGHT GROSS lbs	INNER PACK	MASTER PACK	CU. FT.
Push Button, Stainless Steel Liner & Exterior						
ASCS112	1.2 L/40 oz, 5 1/2" Diameter Base x 8 3/4" Height, 5 7/8" Length x 1" Width Handle (1 7/8" Grip) 1 3/8" Push Button, 1 1/8" Spout	EACH	15.65	1	6	1.31
ASCS115	1.5 L/51 oz, 5 1/2" Diameter Base x 9 5/8" Height, 5 7/8" Length x 1" Width Handle (1 7/8" Grip) 1 3/8" Push Button, 1 1/8" Spout	EACH	16.75	1	6	1.47
ASCS119	1.9 L/64 oz, 5 1/2" Diameter Base x 11 1/8" Height, 5 7/8" Length x 1" Width Handle (1 7/8" Grip) 1 3/8" Push Button, 1 1/8" Spout	EACH	20.94	1	6	1.68
Bru-Thru Lid, Stainless Steel Liner & Exterior						
ASCS019BT	1.9 L/64 oz Coffee Server, S/S Push Button Top with Bru-Thru Lid, 6 1/2" Diameter Base x 6 7/8" Height, 2 3/4" Length x 1" Width Handle (2" Grip) 1 3/8" Push Button, 1" Spout	EACH	18.30	1	6	1.72
ASGD057	5.7 L/1.5 Gallon Gravity Flow Dispenser, with Bru-Thru Lid, Removable Base 14" Base Length x 22 5/8" Height (excluded Handle), 8 5/8" Diameter Server (with 5" x 3 3/8" Dispenser)	EACH	14.52	1	1	2.51



ALTBCR001G ALTBCR111A



ALDCS006

TABLE CRUMBER

Keeps unwanted morsels and crumbs off the table. Gold or silver colored aluminum scraper with pocket clip.



ITEM	DESCRIPTION	U/M	WEIGHT GROSS lbs	INNER PACK	MASTER PACK	CU. FT.
ALTBCR001G	Gold, 6" x 5/8" x 1/2"	EACH	10.14	120	600	0.36
ALTBCR111A	Silver, 6" x 5/8" x 1/2"	EACH	10.14	120	600	0.36
ALDCS006	5 1/2" x 1 1/8" x 1/2"	EACH	4.71	12	144	0.26

SQUEEZE BOTTLE

Great for dispensing liquids, sauces, and other toppings.



PLTHSB008C



PLTHSB008R PLTHSB008Y

ITEM	DESCRIPTION	U/M	WEIGHT GROSS lbs	INNER PACK	MASTER PACK	CU. FT.
8 oz						
PLTHSB008C	8 oz, Clear, 2" Diameter x 7" Height	DOZEN	5.28	6	6	1.18
PLTHSB008R	8 oz, Red, 2" Diameter x 7" Height	DOZEN	5.28	6	6	1.18
PLTHSB008Y	8 oz, Yellow, 2" Diameter x 7" Height	DOZEN	5.28	6	6	1.18
12 oz						
PLTHSB012C	12 oz, Clear, 2 1/8" Diameter x 7" Height	DOZEN	3.03	3	3	0.82
PLTHSB012R	12 oz, Red, 2 1/8" Diameter x 7" Height	DOZEN	3.03	3	3	0.82
PLTHSB012Y	12 oz, Yellow, 2 1/8" Diameter x 7" Height	DOZEN	3.03	3	3	0.82
24 oz						
PLTHSB024C	24 oz, Clear, 2 3/8" Diameter x 9 1/2" Height	DOZEN	5.38	3	3	1.50
PLTHSB024R	24 oz, Red, 2 3/8" Diameter x 9 1/2" Height	DOZEN	5.38	3	3	1.50
PLTHSB024Y	24 oz, Yellow, 2 3/8" Diameter x 9 1/2" Height	DOZEN	5.38	3	3	1.50

*Sold by Master Pack Only

SQUEEZE BOTTLE - WIDE MOUTH

Wide mouth design for easy cleaning and refilling.



PLTHSB024CW

ITEM	DESCRIPTION	U/M	WEIGHT GROSS lbs	INNER PACK	MASTER PACK	CU. FT.
Pack of 6						
16 oz						
PLTHSB016CW	16 oz, Clear, 2 3/4" Diameter x 7 5/8" Height	PACK	14.00	1	12	3.25
PLTHSB016RW	16 oz, Red, 2 3/4" Diameter x 7 5/8" Height	PACK	14.00	1	12	3.25
PLTHSB016YW	16 oz, Yellow, 2 3/4" Diameter x 7 5/8" Height	PACK	14.00	1	12	3.25
24 oz						
PLTHSB024CW	24 oz, Clear, 2 3/4" Diameter x 9 3/8" Height	PACK	17.50	1	12	4.25
PLTHSB024RW	24 oz, Red, 2 3/4" Diameter x 9 3/8" Height	PACK	17.50	1	12	4.25
PLTHSB024YW	24 oz, Yellow, 2 3/4" Diameter x 9 3/8" Height	PACK	17.50	1	12	4.25
32 oz						
PLTHSB032CW	32 oz, Clear, 3 1/8" Diameter x 10 3/8" Height	PACK	17.60	1	12	5.73
PLTHSB032RW	32 oz, Red, 3 1/8" Diameter x 10 3/8" Height	PACK	17.60	1	12	5.73
PLTHSB032YW	32 oz, Yellow, 3 1/8" Diameter x 10 3/8" Height	PACK	17.60	1	12	5.73

ACRYLIC PASTRY DISPLAY & TRAYS

Clear Acrylic cases with sloped front for easy viewing and selection. Hinged rear doors for easy access. Both trays and acrylic trays slide easily. Long-lasting and easy to clean.



ITEM	DESCRIPTION	U/M	WEIGHT GROSS lbs	INNER PACK	MASTER PACK	CU. FT.
PLDC001	21" x 17¼" x 16½" with 3 Trays (Tray size: 20¼" x 13¾" x ¾")	EACH	27.00	1	1	2.13
PLDC002	14" x 24" x 24" with 4 Trays	EACH	37.50	1	1	3.06
PLDCT001	Tray fits PLDC001 & PLDC002, 20¼" x 13¾" x ¾"	EACH	19.71	1	12	0.70

FAST FOOD TRAY



Custom Colors Available
Call for Quote
(PLFFT only)



ITEM	DESCRIPTION	U/M	WEIGHT GROSS lbs	INNER PACK	MASTER PACK	CU. FT.
PLFFT1014BK	10½" x 13¾" x ¾", Black	EACH	30.14	12	48	1.67
PLFFT1014BR	10½" x 13¾" x ¾", Brown	EACH	30.14	12	48	1.67
PLFFT1014GR	10½" x 13¾" x ¾", Green	EACH	30.14	12	48	1.67
PLFFT1014RD	10½" x 13¾" x ¾", Red	EACH	30.14	12	48	1.67
PLFFT1014RR	10½" x 13¾" x ¾", Orange	EACH	30.14	12	48	1.67
PLFFT1216BK	12" x 16¼" x ¾", Black	EACH	39.40	12	48	2.39
PLFFT1216BR	12" x 16¼" x ¾", Brown	EACH	39.40	12	48	2.39
PLFFT1216GR	12" x 16¼" x ¾", Green	EACH	39.40	12	48	2.39
PLFFT1216RD	12" x 16¼" x ¾", Red	EACH	39.40	12	48	2.39
PLFFT1216RR	12" x 16¼" x ¾", Orange	EACH	39.40	12	48	2.39
PLFFT1418BK	14" x 17¾" x ¾", Black	EACH	28.57	12	24	1.53
PLFFT1418BR	14" x 17¾" x ¾", Brown	EACH	28.57	12	24	1.53
PLFFT1418GR	14" x 17¾" x ¾", Green	EACH	28.57	12	24	1.53
PLFFT1418RD	14" x 17¾" x ¾", Red	EACH	28.57	12	24	1.53
PLFFT1418RR	14" x 17¾" x ¾", Orange	EACH	28.57	12	24	1.53

COMPARTMENT TRAY

Multi compartment trays are easy to hold.



SLCRT004



SLCST006

ITEM	DESCRIPTION	U/M	WEIGHT GROSS lbs	INNER PACK	MASTER PACK	CU. FT.
SLCRT004	12½" Diameter x 1" Thickness 4-Compartment	EACH	30.49	6	24	1.12
SLCST006	11⅜" x 15⅜" x 1" Thickness 6-Compartment	EACH	26.36	6	24	1.14

MELAMINE



ML801S - Left Handed

ML802S - Right Handed



ML803T

ML803W



ITEM	DESCRIPTION	U/M	WEIGHT GROSS lbs	INNER PACK	MASTER PACK	CU. FT.
ML801S	14½" x 10" x 1½", Left Handed, Sand	DOZEN	29.85	0.50	2	1.47
ML802S	14½" x 10" x 1½", Right Handed, Sand	DOZEN	29.85	0.50	2	1.47
ML803T	13" x 9½" x 1", Tan	DOZEN	27.56	0.50	2	0.92
ML803W	13" x 9½" x 1", White	DOZEN	27.56	0.50	2	0.92

MOLCAJETE SALSA BOWL

For hot or cold food items. Made of Polypropylene.



PLMJ004BK



PLMJ010BK



PLMJ056BK



Stackable



ITEM	DESCRIPTION	U/M	WEIGHT GROSS lbs	INNER PACK	MASTER PACK	Cu. Ft.
PLMJ004BK	4 oz, 4" Diameter x 1½" Height	PACK OF 4	17.20	1	24	1.22
PLMJ010BK	10 oz, 5⅜" Diameter x 2½" Height	PACK OF 4	19.84	1	12	1.54
PLMJ056BK	56 oz, 8⅝" Diameter x 4" Height	EACH	14.33	1	12	3.18

WOVEN WOOD BOWL

ITEM	DESCRIPTION	U/M	WEIGHT GROSS lbs	INNER PACK	MASTER PACK	CU. FT.
WDTSB006	6" Diameter x 1½" Height	DOZEN	30.86	2	24	1.38
WDTSB008	8" Diameter x 2¼" Height	DOZEN	26.46	2	12	1.13
WDTSB010	10" Diameter x 2½" Height	DOZEN	28.66	1	8	1.48
WDTSB012	12" Diameter x 2¾" Height	DOZEN	26.46	1	6	1.19
WDTSB014	14" Diameter x 3½" Height	DOZEN	41.89	1	4	1.65
WDTSB016	16" Diameter x 4" Height	DOZEN	46.30	1	3	2.29
WDTSB018	18" Diameter x 4" Height	DOZEN	39.68	1	2	2.09
WDTSB020	20" Diameter x 4½" Height	DOZEN	55.00	1	2	2.92



TORTILLA WARMER

Heavy duty polypropylene. Fits up to 8" tortillas. Also fits waffles, pancakes, rolls, toasts, and muffins; keeping them warm at the table.



ITEM	DESCRIPTION	U/M	WEIGHT GROSS lbs	INNER PACK	MASTER PACK	CU. FT.
PLTW085BK	8½" Black, 8½" Diameter x 2¾" Height, Lid: ½" x 8½" Diameter, Knob: 3" Diameter	EACH	18.01	1	18	2.17
PLTW085BR	8½" Terra Cotta, 8½" Diameter x 2¾" Height, Lid: ½" x 8½" Diameter, Knob: 3" Diameter	EACH	18.01	1	18	2.17



TACO HOLDER

Great for serving and/or displaying soft and hard shell tacos as well as hot dogs.

Wire

ITEM	DESCRIPTION	U/M	WEIGHT GROSS lbs	INNER PACK	MASTER PACK	CU. FT.
SLTR012W	1-2 Compartments, 3¾" x 2½" x 1½", with 1⅛" Taco Holder Slot	EACH	31.04	12	144	0.46
SLTR023W	2-3 Compartments, 5¾" x 2½" x 1½", with 1⅛" Taco Holder Slot	EACH	20.11	12	72	0.34
SLTR034W	3-4 Compartments, 7¾" x 2½" x 1½", with 1⅛" Taco Holder Slot	EACH	16.67	12	48	0.30

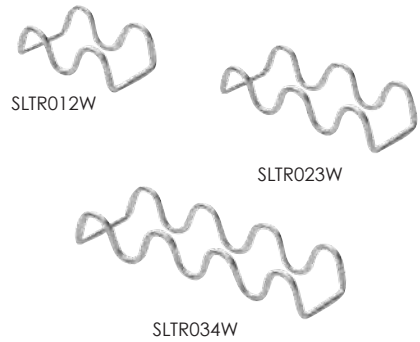

Stainless Steel

ITEM	DESCRIPTION	U/M	WEIGHT GROSS lbs	INNER PACK	MASTER PACK	CU. FT.
SLTR012F	1-2 Compartments, 5½" x 4" x 2", Slot size: 2¾" x 2" x 1⅞"	EACH	38.45	12	96	0.89
SLTR023F	2-3 Compartments, 8¾" x 4" x 2", Slot size: 2¾" x 2" x 1⅞"	EACH	41.20	12	72	0.46
SLTR034F	3-4 Compartments, 11⅞" x 4" x 2", Slot size: 2¾" x 2" x 1⅞"	EACH	38.45	12	48	0.86
SLTR045F	4-5 Compartments, 13⅞" x 4" x 2", Slot size: 2¾" x 2" x 1⅞"	EACH	36.60	12	36	0.80

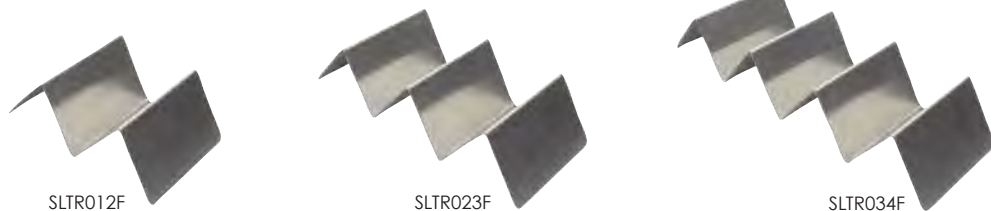
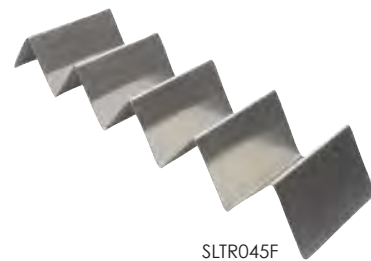

BASKET

Durable plastic basket woven to look like natural straw basket.



PLBB825



PLBB850



PLBB900



PLBB825G



PLBB850G



PLBB900G



PLBB1107



PLBB1209



ITEM	DESCRIPTION	U/M	WEIGHT GROSS lbs	INNER PACK	MASTER PACK	CU. FT.
PLBB825	8" Diameter x 2 1/4" Height, Round	EACH	24.20	12	144	2.74
PLBB850	8 1/4" x 4 1/4" x 2" Oblong	EACH	18.74	12	144	3.24
PLBB900	9 1/4" x 7" x 2 1/4" Oval	EACH	24.25	12	144	2.99
PLBB825G	8" Diameter x 2 1/4" Height, Round, Gold Trim	EACH	17.64	12	144	3.08
PLBB850G	8 1/4" x 4 1/4" x 2" Oblong, Gold Trim	EACH	15.43	12	144	2.36
PLBB900G	9 1/4" x 7" x 2 1/4" Oval, Gold Trim	EACH	18.74	12	144	2.38
PLBB1107	11" x 7" x 3 1/2" Oval	EACH	17.64	1	36	3.18
PLBB1209	12" x 9" x 3" Rectangular	EACH	23.59	1	36	4.64

HANDWOVEN BASKET

Made of high quality polypropylene. Straw mimicking natural materials make them durable and last much longer.



PLBN1208T



PLBN1313T



PLBN1410T

PLBN1813T

ITEM	DESCRIPTION	U/M	WEIGHT GROSS lbs	INNER PACK	MASTER PACK	CU. FT.
PLBN1208T	12" x 8" x 3" w/ Handle	EACH	16.98	1	36	3.15
PLBN1611T	16" x 11" x 3" w/ Handle	EACH	24.25	1	36	3.55
PLBN1712T	17" x 12 3/4" x 3" w/ Handle	EACH	33.51	1	36	7.81
PLBN1313T	13" x 13" x 4 1/2" Square	EACH	31.53	1	36	6.48
PLBN1410T	14" x 10" x 2" Rectangular	EACH	19.84	1	36	2.38
PLBN1813T	18" x 13" x 2" Rectangular	EACH	29.76	1	36	4.48



BASKET - COLORED PLASTIC

Durable polypropylene baskets with smooth bottom surface.



ITEM	DESCRIPTION	U/M	WEIGHT GROSS lbs	INNER PACK	MASTER PACK	CU. FT.
Round						
PLBK008B	8" Diameter x 2" Height, Brown	DOZEN	12.48	1	12	1.88
PLBK008G	8" Diameter x 2" Height, Green	DOZEN	12.48	1	12	1.88
PLBK008K	8" Diameter x 2" Height, Black	DOZEN	12.48	1	12	1.88
PLBK008R	8" Diameter x 2" Height, Red	DOZEN	12.48	1	12	1.88
PLBK008Y	8" Diameter x 2" Height, Yellow	DOZEN	12.48	1	12	1.88
Oblong						
PLBK1034B	10¾" x 7" x 1½", Brown	DOZEN	22.82	1	12	2.44
PLBK1034G	10¾" x 7" x 1½", Green	DOZEN	22.82	1	12	2.44
PLBK1034K	10¾" x 7" x 1½", Black	DOZEN	22.82	1	12	2.44
PLBK1034R	10¾" x 7" x 1½", Red	DOZEN	22.82	1	12	2.44
PLBK1034Y	10¾" x 7" x 1½", Yellow	DOZEN	22.82	1	12	2.44
Oval						
PLBK938B	9¾" x 5½" x 1¾", Brown	DOZEN	10.52	1	12	1.52
PLBK938G	9¾" x 5½" x 1¾", Green	DOZEN	10.52	1	12	1.52
PLBK938K	9¾" x 5½" x 1¾", Black	DOZEN	10.52	1	12	1.52
PLBK938R	9¾" x 5½" x 1¾", Red	DOZEN	10.52	1	12	1.52
PLBK938Y	9¾" x 5½" x 1¾", Yellow	DOZEN	10.52	1	12	1.52
PLBK912G	7¾" x 4¾" x 2¾", Green	DOZEN	13.00	1	12	1.20

PLASTIC SWIRL DESSERT DISH

Add to the pleasure of indulging in ice cream, candies or mints with these tulip shaped bowls. Stackable and durable plastic.



ITEM	DESCRIPTION	U/M	WEIGHT GROSS lbs	INNER PACK	MASTER PACK	CU. FT.
PLDS005C	5 oz, Clear, 3¾" Diameter x 2½" Height	DOZEN	11.90	1	8	0.72
PLDS005B	5 oz, Blue, 3¾" Diameter x 2½" Height	DOZEN	11.90	1	8	0.72
PLDS005K	5 oz, Black, 3¾" Diameter x 2½" Height	DOZEN	11.90	1	8	0.72
PLDS005P	5 oz, Purple, 3¾" Diameter x 2½" Height	DOZEN	11.90	1	8	0.72

BELIZE® TUMBLER

Unique Swirl Design presents a perfect glass-like table top tumbler presentation.



Starburst® Design
Minimizes skidding on wet surfaces while allowing residual water to drain away when placed in an inverted position for stacking and storing.



10 oz

- Sizes:
- Blue
 - Clear
 - Red
 - Green

- 8 oz**
- 10 oz**
- 12 oz**
- 14 oz**
- 16 oz**
- 20 oz**
- 24 oz**

ITEM	DESCRIPTION	Rim-Full CAPACITY	U/M	WEIGHT GROSS lbs	INNER PACK	MASTER PACK	CU. FT.
8 oz							
PLPCTB308BL	8 oz Blue, 2 $\frac{5}{8}$ " Diameter x 4 $\frac{3}{8}$ " Height	8 oz	DOZEN	9.55	1	4	1.18
PLPCTB308CL	8 oz Clear, 2 $\frac{5}{8}$ " Diameter x 4 $\frac{3}{8}$ " Height	8 oz	DOZEN	9.55	1	4	1.18
PLPCTB308GR	8 oz Green, 2 $\frac{5}{8}$ " Diameter x 4 $\frac{3}{8}$ " Height	8 oz	DOZEN	9.55	1	4	1.18
PLPCTB308RD	8 oz Red, 2 $\frac{5}{8}$ " Diameter x 4 $\frac{3}{8}$ " Height	8 oz	DOZEN	9.55	1	4	1.18
10 oz							
PLPCTB310BL	10 oz Blue, 3" Diameter x 5" Height	12 oz	DOZEN	11.71	1	4	0.83
PLPCTB310CL	10 oz Clear, 3" Diameter x 5" Height	12 oz	DOZEN	11.71	1	4	0.83
PLPCTB310GR	10 oz Green, 3" Diameter x 5" Height	12 oz	DOZEN	11.71	1	4	0.83
PLPCTB310RD	10 oz Red, 3" Diameter x 5" Height	12 oz	DOZEN	11.71	1	4	0.83
12 oz							
PLPCTB312BL	12 oz Blue, 3 $\frac{1}{8}$ " Diameter x 5 $\frac{3}{8}$ " Height	14 oz	DOZEN	12.99	1	4	0.86
PLPCTB312CL	12 oz Clear, 3 $\frac{1}{8}$ " Diameter x 5 $\frac{3}{8}$ " Height	14 oz	DOZEN	12.99	1	4	0.86
PLPCTB312GR	12 oz Green, 3 $\frac{1}{8}$ " Diameter x 5 $\frac{3}{8}$ " Height	14 oz	DOZEN	12.99	1	4	0.86
PLPCTB312RD	12 oz Red, 3 $\frac{1}{8}$ " Diameter x 5 $\frac{3}{8}$ " Height	14 oz	DOZEN	12.99	1	4	0.86
14 oz							
PLPCTB314BL	14 oz Blue, 3 $\frac{1}{8}$ " Diameter x 5 $\frac{7}{8}$ " Height	16 oz	DOZEN	14.24	1	4	1.00
PLPCTB314CL	14 oz Clear, 3 $\frac{1}{8}$ " Diameter x 5 $\frac{7}{8}$ " Height	16 oz	DOZEN	14.24	1	4	1.00
PLPCTB314GR	14 oz Green, 3 $\frac{1}{8}$ " Diameter x 5 $\frac{7}{8}$ " Height	16 oz	DOZEN	14.24	1	4	1.00
PLPCTB314RD	14 oz Red, 3 $\frac{1}{8}$ " Diameter x 5 $\frac{7}{8}$ " Height	16 oz	DOZEN	14.24	1	4	1.00
16 oz							
PLPCTB316BL	16 oz Blue, 3 $\frac{1}{2}$ " Diameter x 6 $\frac{1}{8}$ " Height	18 oz	DOZEN	15.61	1	4	1.07
PLPCTB316CL	16 oz Clear, 3 $\frac{1}{2}$ " Diameter x 6 $\frac{1}{8}$ " Height	18 oz	DOZEN	15.61	1	4	1.07
PLPCTB316GR	16 oz Green, 3 $\frac{1}{2}$ " Diameter x 6 $\frac{1}{8}$ " Height	18 oz	DOZEN	15.61	1	4	1.07
PLPCTB316RD	16 oz Red, 3 $\frac{1}{2}$ " Diameter x 6 $\frac{1}{8}$ " Height	18 oz	DOZEN	15.61	1	4	1.07
20 oz							
PLPCTB320BL	20 oz Blue, 3 $\frac{1}{2}$ " Diameter x 6 $\frac{1}{2}$ " Height	22 oz	DOZEN	15.29	1	4	1.20
PLPCTB320CL	20 oz Clear, 3 $\frac{1}{2}$ " Diameter x 6 $\frac{1}{2}$ " Height	22 oz	DOZEN	15.29	1	4	1.20
PLPCTB320GR	20 oz Green, 3 $\frac{1}{2}$ " Diameter x 6 $\frac{1}{2}$ " Height	22 oz	DOZEN	15.29	1	4	1.20
PLPCTB320RD	20 oz Red, 3 $\frac{1}{2}$ " Diameter x 6 $\frac{1}{2}$ " Height	22 oz	DOZEN	15.29	1	4	1.20
24 oz							
PLPCTB324BL	24 oz Blue, 3 $\frac{5}{8}$ " Diameter x 6 $\frac{7}{8}$ " Height	26 oz	DOZEN	19.78	1	4	1.45
PLPCTB324CL	24 oz Clear, 3 $\frac{5}{8}$ " Diameter x 6 $\frac{7}{8}$ " Height	26 oz	DOZEN	19.78	1	4	1.45
PLPCTB324GR	24 oz Green, 3 $\frac{5}{8}$ " Diameter x 6 $\frac{7}{8}$ " Height	26 oz	DOZEN	19.78	1	4	1.45
PLPCTB324RD	24 oz Red, 3 $\frac{5}{8}$ " Diameter x 6 $\frac{7}{8}$ " Height	26 oz	DOZEN	19.78	1	4	1.45



DIAMOND TUMBLER

These tumblers are scratch resistant, crystal glass-like and virtually Unbreakable.

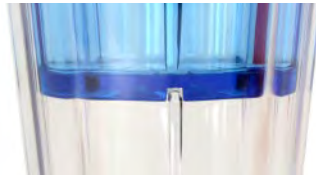

All Diamond tumblers feature stackable Anti-Jam locking tabs



ITEM	DESCRIPTION	Rim-Full CAPACITY	U/M	WEIGHT GROSS lbs	INNER PACK	MASTER PACK	CU. FT.
8 oz							
PLPCTB108CL	8 oz Clear, 3 1/8" Diameter x 3 1/4" Height	8 oz	DOZEN	8.43	1	4	0.87
PLPCTB108BL	8 oz Blue, 3 1/8" Diameter x 3 1/4" Height	8 oz	DOZEN	8.43	1	4	0.87
PLPCTB108GR	8 oz Green, 3 1/8" Diameter x 3 1/4" Height	8 oz	DOZEN	8.43	1	4	0.87
PLPCTB108RD	8 oz Red, 3 1/8" Diameter x 3 1/4" Height	8 oz	DOZEN	8.43	1	4	0.87
10 oz							
PLPCTB110CL	10 oz Clear, 3" Diameter x 4 3/4" Height	12 oz	DOZEN	11.24	1	4	0.87
PLPCTB110BL	10 oz Blue, 3" Diameter x 4 3/4" Height	12 oz	DOZEN	11.24	1	4	0.87
PLPCTB110GR	10 oz Green, 3" Diameter x 4 3/4" Height	12 oz	DOZEN	11.24	1	4	0.87
PLPCTB110RD	10 oz Red, 3" Diameter x 4 3/4" Height	12 oz	DOZEN	11.24	1	4	0.87
12 oz							
PLPCTB112CL	12 oz Clear, 3 1/8" Diameter x 5 1/8" Height	14 oz	DOZEN	12.06	1	4	0.98
PLPCTB112BL	12 oz Blue, 3 1/8" Diameter x 5 1/8" Height	14 oz	DOZEN	12.06	1	4	0.98
PLPCTB112GR	12 oz Green, 3 1/8" Diameter x 5 1/8" Height	14 oz	DOZEN	12.06	1	4	0.98
PLPCTB112RD	12 oz Red, 3 1/8" Diameter x 5 1/8" Height	14 oz	DOZEN	12.06	1	4	0.98
14 oz							
PLPCTB114CL	14 oz Clear, 3 1/4" Diameter x 5 1/8" Height	16 oz	DOZEN	13.56	1	4	1.21
PLPCTB114BL	14 oz Blue, 3 1/4" Diameter x 5 1/8" Height	16 oz	DOZEN	13.56	1	4	1.21
PLPCTB114GR	14 oz Green, 3 1/4" Diameter x 5 1/8" Height	16 oz	DOZEN	13.56	1	4	1.21
PLPCTB114RD	14 oz Red, 3 1/4" Diameter x 5 1/8" Height	16 oz	DOZEN	13.56	1	4	1.21
16 oz							
PLPCTB116CL	16 oz Clear, 3 1/2" Diameter x 5 7/8" Height	18 oz	DOZEN	14.77	1	4	1.26
PLPCTB116BL	16 oz Blue, 3 1/2" Diameter x 5 7/8" Height	18 oz	DOZEN	14.77	1	4	1.26
PLPCTB116GR	16 oz Green, 3 1/2" Diameter x 5 7/8" Height	18 oz	DOZEN	14.77	1	4	1.26
PLPCTB116RD	16 oz Red, 3 1/2" Diameter x 5 7/8" Height	18 oz	DOZEN	14.77	1	4	1.26
20 oz							
PLPCTB120CL	20 oz Clear, 3 5/8" Diameter x 6" Height	22 oz	DOZEN	18.92	1	4	1.87
PLPCTB120BL	20 oz Blue, 3 5/8" Diameter x 6" Height	22 oz	DOZEN	18.92	1	4	1.87
PLPCTB120GR	20 oz Green, 3 5/8" Diameter x 6" Height	22 oz	DOZEN	18.92	1	4	1.87
PLPCTB120RD	20 oz Red, 3 5/8" Diameter x 6" Height	22 oz	DOZEN	18.92	1	4	1.87
24 oz							
PLPCTB124CL	24 oz Clear, 3 5/8" Diameter x 6 5/8" Height	26 oz	DOZEN	21.01	1	4	2.30
PLPCTB124BL	24 oz Blue, 3 5/8" Diameter x 6 5/8" Height	26 oz	DOZEN	21.01	1	4	2.30
PLPCTB124GR	24 oz Green, 3 5/8" Diameter x 6 5/8" Height	26 oz	DOZEN	21.01	1	4	2.30
PLPCTB124RD	24 oz Red, 3 5/8" Diameter x 6 5/8" Height	26 oz	DOZEN	21.01	1	4	2.30



8 oz (Rock Glass)



14 oz

Sizes:

- Blue **8 oz**
- Clear **12 oz**
- Red **16 oz**
- Green **20 oz**
- 24 oz**



9 1/2 oz Red



12 oz Clear



16 oz Amber



20 oz Blue



PLPTB016A

PLPTB016C

TUMBLER

Textured exterior resists scratching and plastic is impact resistant. Stackable and dishwasher safe. 176° F max temperature.



ITEM	DESCRIPTION	U/M	WEIGHT GROSS lbs	INNER PACK	MASTER PACK	CU. FT.
5 oz						
PLTHTB005A	5 oz Amber, 2 3/8" Diameter x 3 5/8" Height	DOZEN	6.39	1	6	0.62
PLTHTB005B	5 oz Blue, 2 3/8" Diameter x 3 5/8" Height	DOZEN	6.39	1	6	0.62
PLTHTB005C	5 oz Clear, 2 3/8" Diameter x 3 5/8" Height	DOZEN	6.39	1	6	0.62
PLTHTB005R	5 oz Red, 2 3/8" Diameter x 3 5/8" Height	DOZEN	6.39	1	6	0.62
8 oz						
PLTHTB008A	8 oz Amber, 2 5/8" Diameter x 4" Height	DOZEN	8.09	1	6	0.77
PLTHTB008B	8 oz Blue, 2 5/8" Diameter x 4" Height	DOZEN	8.09	1	6	0.77
PLTHTB008C	8 oz Clear, 2 5/8" Diameter x 4" Height	DOZEN	8.09	1	6	0.77
PLTHTB008R	8 oz Red, 2 5/8" Diameter x 4" Height	DOZEN	8.09	1	6	0.77
9 1/2 oz						
PLTHTB010A	9 1/2 oz Amber, 2 3/4" Diameter x 4 1/2" Height	DOZEN	7.89	1	6	0.85
PLTHTB010B	9 1/2 oz Blue, 2 3/4" Diameter x 4 1/2" Height	DOZEN	7.89	1	6	0.85
PLTHTB010C	9 1/2 oz Clear, 2 3/4" Diameter x 4 1/2" Height	DOZEN	7.89	1	6	0.85
PLTHTB010R	9 1/2 oz Red, 2 3/4" Diameter x 4 1/2" Height	DOZEN	7.89	1	6	0.85
12 oz						
PLTHTB012A	12 oz Amber, 3" Diameter x 5" Height	DOZEN	10.56	1	6	1.03
PLTHTB012B	12 oz Blue, 3" Diameter x 5" Height	DOZEN	10.56	1	6	1.03
PLTHTB012C	12 oz Clear, 3" Diameter x 5" Height	DOZEN	10.56	1	6	1.03
PLTHTB012R	12 oz Red, 3" Diameter x 5" Height	DOZEN	10.56	1	6	1.03
16 oz						
PLTHTB016A	16 oz Amber, 3 1/8" Diameter x 5 5/8" Height	DOZEN	14.79	1	6	1.26
PLTHTB016B	16 oz Blue, 3 1/8" Diameter x 5 5/8" Height	DOZEN	14.79	1	6	1.26
PLTHTB016C	16 oz Clear, 3 1/8" Diameter x 5 5/8" Height	DOZEN	14.79	1	6	1.26
PLTHTB016R	16 oz Red, 3 1/8" Diameter x 5 5/8" Height	DOZEN	14.79	1	6	1.26
20 oz						
PLTHTB020A	20 oz Amber, 3 3/4" Diameter x 6 1/2" Height	DOZEN	20.33	1	6	1.73
PLTHTB020B	20 oz Blue, 3 3/4" Diameter x 6 1/2" Height	DOZEN	20.33	1	6	1.73
PLTHTB020C	20 oz Clear, 3 3/4" Diameter x 6 1/2" Height	DOZEN	20.33	1	6	1.73
PLTHTB020R	20 oz Red, 3 3/4" Diameter x 6 1/2" Height	DOZEN	20.33	1	6	1.73
24 oz						
PLTHTB024A	24 oz Amber, 3 3/4" Diameter x 7" Height	DOZEN	17.28	1	6	1.60
PLTHTB024B	24 oz Blue, 3 3/4" Diameter x 7" Height	DOZEN	17.28	1	6	1.60
PLTHTB024C	24 oz Clear, 3 3/4" Diameter x 7" Height	DOZEN	17.28	1	6	1.60
PLTHTB024R	24 oz Red, 3 3/4" Diameter x 7" Height	DOZEN	17.28	1	6	1.60
32 oz						
PLTHTB032A	32 oz Amber, 4 1/8" Diameter x 6 5/8" Height	DOZEN	8.40	1	2	1.01
PLTHTB032B	32 oz Blue, 4 1/8" Diameter x 6 5/8" Height	DOZEN	8.40	1	2	1.01
PLTHTB032C	32 oz Clear, 4 1/8" Diameter x 6 5/8" Height	DOZEN	8.40	1	2	1.01
PLTHTB032R	32 oz Red, 4 1/8" Diameter x 6 5/8" Height	DOZEN	8.40	1	2	1.01
PLTHTB032TA	32 oz Amber Tall, 4" Diameter x 7 1/4" Height	DOZEN	7.39	1	2	0.99
PLTHTB032TB	32 oz Blue Tall, 4" Diameter x 7 1/4" Height	DOZEN	7.39	1	2	0.99
PLTHTB032TC	32 oz Clear Tall, 4" Diameter x 7 1/4" Height	DOZEN	7.39	1	2	0.99
PLTHTB032TR	32 oz Red Tall, 4" Diameter x 7 1/4" Height	DOZEN	7.39	1	2	0.99
16 oz Pebble Tumbler						
PLPTB016A	16 oz, Amber, 3" Diameter x 5 5/8" Height	DOZEN	17.20	1	6	2.50
PLPTB016C	16 oz, Clear, 3" Diameter x 5 5/8" Height	DOZEN	17.20	1	6	2.50

STEAK AND BREAD KNIFE

A wide selection of stainless steel bread knives and steak knives with sharp serrated edges.



SLSK008 SLSK016 SLSK017 SLSK GK001 SLBK013 SLSK108 SLSK116 SLSK117 SLSK GK002

ITEM	DESCRIPTION	U/M	WEIGHT GROSS lbs	INNER PACK	MASTER PACK	CU. FT.
Wood Handle						
SLSK008	4½" Blade Pointed Tip Steak Knife, 8¾" x ½"	DOZEN	35.27	2	40	0.77
SLSK016	4" Blade Round Tip Steak Knife, 8¼" x ⅝"	DOZEN	35.27	2	40	0.77
SLSK017	4¼" Blade Wood Handle, 8⅝" x ½"	DOZEN	35.20	2	50	0.70
SLSK GK001	5" Blade Round Tip Jumbo Knife, 9⅞" x 1"	DOZEN	37.08	1	15	0.84
SLBK013	8½" Blade Bread Knife, 13½" x 1⅞"	DOZEN	36.16	1	10	0.77
Plastic Handle						
SLSK108	4¾" Blade Pointed Tip Steak Knife, 8⅝" x ¾"	DOZEN	33.00	2	40	0.93
SLSK116	5" Blade Round Tip Steak Knife, 8⅝" x ¾"	DOZEN	35.27	2	40	0.93
SLSK117	4¼" Blade, Plastic Handle, 7⅞" x ½"	DOZEN	24.30	2	50	0.54
SLSK GK002	5" Blade Round Tip Jumbo Knife, 10" x 1¼"	DOZEN	37.08	1	15	0.72

FAJITA BOARD AND CAST IRON SKILLET

¾" thick wooden fajita board with side grooves to catch sauce or grease. Easy to clean and can be stacked when stored.



ITEM	DESCRIPTION	U/M	WEIGHT GROSS lbs	INNER PACK	MASTER PACK	CU. FT.
WDFJ001	Fajita Board, 12¼" x 8" x ¾"	EACH	11.68	12	12	0.49
IRSK795	7" x 9¼" Cast Iron Skillet	EACH	38.03	1	12	1.61

GRIDDLE SET

This 3-piece griddle set includes cast-iron griddle, gripper, and wood underliner. Safely handle hot griddles with the sturdy grippers and placed them over the wood underliner.

ITEM	DESCRIPTION	U/M	WEIGHT GROSS lbs	INNER PACK	MASTER PACK	CU. FT.
IRBB001	Pork Board, Gripper: 5" x 1½" x 1" / Griddle: 10½" x 6¾" x 1" / Wooden Board: 12½" x 7⅞" x ⅝"	EACH	39.70	10	10	1.29
IRBB002	Steak Board, Gripper: 6" x 1½" x ½" / Griddle: 8½" x 5⅞" x ⅞" / Wooden Board: 14¾" x 8¼" x ⅝"	EACH	66.10	10	10	1.63

***Sold by Master Pack Only**



SIZZLING PLATTER

Stainless steel platter offers elegant presentation with accommodating thermal Sizzling platter (sold separately).



ITEM	DESCRIPTION	U/M	WEIGHT GROSS lbs	INNER PACK	MASTER PACK	CU. FT.
IRSP1107	11" x 7⅞" x ½" Rectangular	EACH	49.20	12	60	3.18
IRSP1108	11⅞" x 8" x ⅝" Oval	EACH	52.00	12	60	4.24



IRSP1107



IRSP1108

BAKELITE UNDERLINER

Black thermal platter offers elegant presentation.

ITEM	DESCRIPTION	U/M	WEIGHT GROSS lbs	INNER PACK	MASTER PACK	CU. FT.
WDSP1107	Fits IRSP1107, Rectangular 13" x 8" x 1"	EACH	59.50	12	60	2.52
WDSP1108	Fits IRSP1108, Oval 13⅞" x 8⅞" x 1"	EACH	70.50	12	60	4.87



WDSP1107



WDSP1108

ESCARGOT TRAY, TONG & FORK

A number of special items are needed to properly serve escargot, including a plate, tong and a fork. Snail plate has six slight depressions in which the escargot shells sit in order to keep them from rolling across the plate.



ITEM	DESCRIPTION	U/M	WEIGHT GROSS lbs	INNER PACK	MASTER PACK	CU. FT.
SLSN006D	Dish, 6 Holes, 7½" x 5½" x ⅝"	EACH	34.50	12	144	0.70
SLSN006T	Squeeze Tong, 6½" x 1½" x 1"	EACH	43.83	24	600	2.04
SLSN006F	Fork, 6" x ⅝" x 1"	DOZEN	24.69	1	50	0.25



SLSN006D



SLSN006T



SLSN006F

GRAPEFRUIT SPOON w/SERRATED EDGE

A durable mirror finished spoon with serrated edges to easily scoop out the grapefruit.



ITEM	DESCRIPTION	U/M	WEIGHT GROSS lbs	INNER PACK	MASTER PACK	CU. FT.
SLGF004	Spoon with Serrated Edge 6¾" x 1½" x ¼"	DOZEN	26.46	1	36	0.30

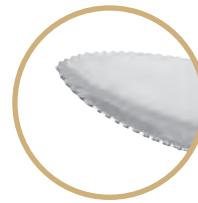

SLGF004

LOBSTER CRACKER

Jagged ridges can crack small or large claws. Wide swing handles.

ITEM	DESCRIPTION	U/M	WEIGHT GROSS lbs	INNER PACK	MASTER PACK	CU. FT.
SLLC006A	6" x 1¼" x ⅜" Zinc Alloy	EACH	40.79	24	144	1.45
SLLC006B	6" x 1½" x ⅜" Cast Steel	EACH	57.11	12	144	0.76
SLLC116W	6" x 1½" x ½" Wood Handle	EACH	34.10	12	144	1.62



SLLC006A



SLLC006A



SLLC006B



SLLC116W

CLAM KNIFE

ITEM	DESCRIPTION	U/M	WEIGHT GROSS lbs	INNER PACK	MASTER PACK	CU. FT.
SLTWCK007	7¼" x ⅞" x ½" Clam Knife	EACH	30.20	12	240	0.57



SLTWCK007



ATLANTIC

ITEM	DESCRIPTION	U/M	WEIGHT GROSS lbs	INNER PACK	MASTER PACK	CU. FT.
SLAT201	Demitasse Spoon	DOZEN	12.10	1	25	0.23
SLAT202	Teaspoon	DOZEN	23.76	1	25	0.40
SLAT203	Bouillon Spoon	DOZEN	26.40	1	25	0.54
SLAT204	Dinner Spoon	DOZEN	38.06	1	25	0.61
SLAT205	Iced Tea Spoon	DOZEN	22.88	1	25	0.54
SLAT206	Dinner Fork	DOZEN	32.78	1	25	0.50
SLAT207	Salad Fork	DOZEN	22.88	1	25	0.56
SLAT209	Dinner Knife	DOZEN	40.48	1	15	0.50
SLAT210	Table Spoon (European Size)	DOZEN	45.10	1	25	0.84
SLAT211	Butter Knife	DOZEN	22.22	1	25	0.44
SLAT212	Table Fork (European Size)	DOZEN	36.52	1	25	0.69
SLAT215	Hollow Handle Table Knife	DOZEN	35.86	1	15	0.68
SLAT216	Steak Knife	DOZEN	33.00	1	15	0.41
SLAT218	Table Knife (European Size)	DOZEN	44.44	1	15	0.52
SLAT219	Salad Knife	DOZEN	33.66	1	15	0.38

18/10 **SS** STAINLESS STEEL



DIAMOND

ITEM	DESCRIPTION	U/M	WEIGHT GROSS lbs	INNER PACK	MASTER PACK	CU. FT.
SLDM201	Demitasse Spoon	DOZEN	10.12	1	25	0.23
SLDM202	Teaspoon	DOZEN	22.44	1	25	0.40
SLDM203	Bouillon Spoon	DOZEN	23.54	1	25	0.54
SLDM204	Dinner Spoon	DOZEN	34.76	1	25	0.61
SLDM205	Iced Tea Spoon	DOZEN	22.22	1	25	0.54
SLDM206	Dinner Fork	DOZEN	26.84	1	25	0.50
SLDM207	Salad Fork	DOZEN	17.82	1	25	0.40
SLDM208	Oyster Fork	DOZEN	13.64	1	25	0.26
SLDM209	Dinner Knife	DOZEN	37.62	1	15	0.50
SLDM210	Table Spoon (European Size)	DOZEN	48.40	1	25	0.84
SLDM211	Butter Knife	DOZEN	16.72	1	25	0.44
SLDM212	Table Fork (European Size)	DOZEN	41.80	1	25	0.69
SLDM215	Hollow Handle Dinner Knife	DOZEN	29.70	1	15	0.68
SLDM218	Hollow Handle Table Knife	DOZEN	36.96	1	15	0.68





ELIZABETH

ITEM	DESCRIPTION	U/M	WEIGHT GROSS lbs	INNER PACK	MASTER PACK	CU. FT.
SLEL201	Demitasse Spoon	DOZEN	10.78	1	25	0.23
SLEL202	Teaspoon	DOZEN	25.08	1	25	0.40
SLEL203	Bouillon Spoon	DOZEN	25.08	1	25	0.54
SLEL204	Dinner Spoon	DOZEN	39.60	1	25	0.61
SLEL205	Iced Tea Spoon	DOZEN	20.46	1	25	0.54
SLEL206	Dinner Fork	DOZEN	34.98	1	25	0.50
SLEL207	Salad Fork	DOZEN	23.54	1	25	0.56
SLEL208	Oyster Fork	DOZEN	15.62	1	25	0.26
SLEL209	Dinner Knife	DOZEN	38.28	1	15	0.41
SLEL210	Table Spoon (European Size)	DOZEN	48.40	1	25	0.84
SLEL211	Butter Knife	DOZEN	20.24	1	25	0.44
SLEL212	Table Fork (European Size)	DOZEN	41.14	1	25	0.69
SLEL218	Table Knife (European Size)	DOZEN	48.84	1	15	0.52

18/10  STAINLESS
STEEL



SIMPLICITY

ITEM	DESCRIPTION	U/M	WEIGHT GROSS lbs	INNER PACK	MASTER PACK	CU. FT.
SLSM202	Teaspoon	DOZEN	25.08	1	25	0.40
SLSM203	Bouillon Spoon	DOZEN	26.40	1	25	0.54
SLSM204	Dinner Spoon	DOZEN	44.00	1	25	0.61
SLSM205	Iced Tea Spoon	DOZEN	26.18	1	25	0.54
SLSM206	Dinner Fork	DOZEN	38.06	1	25	0.50
SLSM207	Salad Fork	DOZEN	26.18	1	25	0.26
SLSM208	Oyster Fork	DOZEN	17.82	1	25	0.56
SLSM209	Dinner Knife	DOZEN	43.78	1	15	0.52
SLSM210	Table Spoon	DOZEN	51.04	1	25	0.84
SLSM211	Butter Knife	DOZEN	21.34	1	25	0.44
SLSM212	Table Fork	DOZEN	41.80	1	25	0.69

18/10  STAINLESS
STEEL



WILSHIRE

ITEM	DESCRIPTION	U/M	WEIGHT GROSS lbs	INNER PACK	MASTER PACK	CU. FT.
SLWH201	Demitasse Spoon	DOZEN	10.78	1	25	0.23
SLWH202	Teaspoon	DOZEN	23.10	1	25	0.40
SLWH203	Bouillon Spoon	DOZEN	25.08	1	25	0.54
SLWH204	Dinner Spoon	DOZEN	38.94	1	25	0.61
SLWH205	Iced Tea Spoon	DOZEN	22.44	1	25	0.54
SLWH206	Dinner Fork	DOZEN	33.00	1	25	0.50
SLWH207	Salad Fork	DOZEN	24.86	1	25	0.56
SLWH208	Oyster Fork	DOZEN	14.96	1	25	0.26
SLWH209	Dinner Knife	DOZEN	39.82	1	15	0.52
SLWH210	Table Spoon (European Size)	DOZEN	50.38	1	25	0.84
SLWH211	Butter Knife	DOZEN	22.88	1	25	0.44
SLWH212	Table Fork (European Size)	DOZEN	38.50	1	25	0.69
SLWH216	Salad Knife	DOZEN	52.80	1	25	0.38

18/10  STAINLESS STEEL



YORK

ITEM	DESCRIPTION	U/M	WEIGHT GROSS lbs	INNER PACK	MASTER PACK	CU. FT.
SLYK201	Demitasse Spoon	DOZEN	12.10	1	25	0.23
SLYK202	Teaspoon	DOZEN	25.08	1	25	0.40
SLYK203	Bouillon Spoon	DOZEN	26.40	1	25	0.54
SLYK204	Dinner Spoon	DOZEN	42.02	1	25	0.61
SLYK205	Iced Tea Spoon	DOZEN	23.10	1	25	0.54
SLYK206	Dinner Fork	DOZEN	33.00	1	25	0.50
SLYK207	Salad Fork	DOZEN	22.22	1	25	0.56
SLYK208	Oyster Fork	DOZEN	14.96	1	25	0.26
SLYK209	Dinner Knife	DOZEN	39.82	1	15	0.52
SLYK210	Table Spoon	DOZEN	49.72	1	25	0.84
SLYK211	Butter Knife	DOZEN	22.22	1	25	0.44
SLYK212	Table Fork	DOZEN	39.82	1	25	0.69

18/10  STAINLESS
STEEL



DAKOTA SATIN

A durable finished, stainless steel flatware set, serves sweets or a full course meal with simple line-trimmed handle.

ITEM	DESCRIPTION	U/M	WEIGHT GROSS lbs	INNER PACK	MASTER PACK	CU. FT.
SLDK102	Teaspoon	DOZEN	36.40	1	50	0.45
SLDK103	Bouillon Spoon	DOZEN	40.40	1	50	0.58
SLDK104	Dessert Spoon	DOZEN	51.00	1	50	0.82
SLDK105	Iced Tea Spoon	DOZEN	40.40	1	50	0.34
SLDK106F	Dinner Fork 4 Tines	DOZEN	45.60	1	50	0.55
SLDK106	Dinner Fork	DOZEN	43.10	1	50	0.39
SLDK107	Salad Fork	DOZEN	32.40	1	50	0.40
SLDK108	Oyster Fork	DOZEN	28.50	1	50	0.28
SLDK109	Dinner Knife	DOZEN	56.60	1	25	0.35



STAINLESS STEEL



↓ 2.0 mm to
↑ 2.2 mm Thickness



TAHOE

A durable shiny finished, stainless steel flatware set, serves sweets or a full course meal with simple line-trimmed handle.

ITEM	DESCRIPTION	U/M	WEIGHT GROSS lbs	INNER PACK	MASTER PACK	CU. FT.
SLTE102	Teaspoon	DOZEN	32.40	1	50	0.46
SLTE103	Bouillon Spoon	DOZEN	39.20	1	50	0.73
SLTE104	Dessert Spoon	DOZEN	45.60	1	50	0.75
SLTE106	Dinner Fork	DOZEN	40.50	1	50	0.60
SLTE107	Salad Fork	DOZEN	32.40	1	50	0.48
SLTE109	Dinner Knife	DOZEN	46.00	1	25	0.51



STAINLESS STEEL



↓ 2.0 mm to
↑ 2.2 mm Thickness

SALEM

A durable satin finished, stainless steel flatware set, serves sweets or a full course meal with shaped decoration on handle neck.

ITEM	DESCRIPTION	U/M	WEIGHT GROSS lbs	INNER PACK	MASTER PACK	CU. FT.
SLAM102	Teaspoon	DOZEN	40.50	1	50	0.45
SLAM103	Bouillon Spoon	DOZEN	44.40	1	50	0.60
SLAM104	Dessert Spoon	DOZEN	57.70	1	50	0.69
SLAM105	Iced Tea Spoon	DOZEN	47.10	1	50	0.58
SLAM106	Dinner Fork	DOZEN	51.10	1	50	0.61
SLAM107	Salad Fork	DOZEN	35.20	1	50	0.41
SLAM109	Dinner Knife	DOZEN	50.00	1	25	0.34



↓ 2.0 mm to
↑ 2.2 mm Thickness

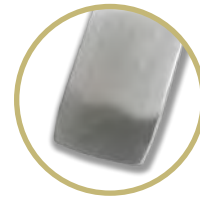

ESQUIRE

A durable satin finished, stainless steel flatware set.

ITEM	DESCRIPTION	U/M	WEIGHT GROSS lbs	INNER PACK	MASTER PACK	CU. FT.
SLES102	Teaspoon	DOZEN	40.50	1	50	0.45
SLES103	Bouillon Spoon	DOZEN	41.90	1	50	0.60
SLES104	Dessert Spoon	DOZEN	60.40	1	50	0.69
SLES105	Iced Tea Spoon	DOZEN	48.30	1	50	0.58
SLES106	Dinner Fork	DOZEN	47.00	1	50	0.61
SLES107	Salad Fork	DOZEN	41.90	1	50	0.41
SLES109	Dinner Knife	DOZEN	54.00	1	25	0.34



↓ 2.0 mm to
↑ 2.2 mm Thickness





LEGEND

A durable mirror finished, stainless steel flatware set.

ITEM	DESCRIPTION	U/M	WEIGHT GROSS lbs	INNER PACK	MASTER PACK	CU. FT.
SLGD001	Sugar Spoon	DOZEN	24.06	1	36	0.32
SLGD002	Teaspoon	DOZEN	34.51	1	36	0.54
SLGD003	Bouillon Spoon	DOZEN	35.46	1	36	0.67
SLGD004	Dessert Spoon	DOZEN	51.62	1	36	0.84
SLGD005	Iced Tea Spoon	DOZEN	39.27	1	36	0.61
SLGD006	Dinner Fork	DOZEN	43.07	1	36	0.66
SLGD007	Salad Fork	DOZEN	35.46	1	36	0.62
SLGD008	Oyster Fork	DOZEN	20.26	1	36	0.33
SLGD009	Dinner Knife	DOZEN	43.07	1	18	0.33
SLGD010	Table Spoon	DOZEN	42.12	1	18	0.62
SLGD011	Dinner Butter Knife	DOZEN	36.41	1	36	0.35



↓ 2.5 mm to
↑ 3.0 mm
Thickness



JEWEL

A durable mirror finished, stainless steel flatware set.

ITEM	DESCRIPTION	U/M	WEIGHT GROSS lbs	INNER PACK	MASTER PACK	CU. FT.
SLNP001	Demitasse Spoon	DOZEN	22.00	1	50	0.37
SLNP002	Teaspoon	DOZEN	35.20	1	50	0.70
SLNP003	Bouillon Spoon	DOZEN	41.80	1	50	0.83
SLNP004	Dessert Spoon	DOZEN	60.28	1	50	0.97
SLNP005	Iced Tea Spoon	DOZEN	45.76	1	50	0.94
SLNP006	Dinner Fork	DOZEN	53.68	1	50	0.70
SLNP007	Salad Fork	DOZEN	33.88	1	50	0.80
SLNP008	Oyster Fork	DOZEN	31.24	1	50	0.46
SLNP009	Dinner Knife	DOZEN	39.16	1	20	0.31
SLNP010	Table Spoon	DOZEN	81.40	1	50	1.52
SLNP011	Dinner Butter Knife	DOZEN	35.20	1	50	0.50



↓ 2.5 mm to
↑ 3.0 mm
Thickness

SUNFLOWER

A durable shiny finished, stainless steel flatware set, serves sweets or a full course meal with sunflower decoration handle.

ITEM	DESCRIPTION	U/M	WEIGHT GROSS lbs	INNER PACK	MASTER PACK	CU. FT.
SLSF111	Demitasse Spoon	DOZEN	24.64	1	50	0.36
SLSF112	Teaspoon	DOZEN	37.84	1	50	0.63
SLSF113	Bouillon Spoon	DOZEN	40.48	1	50	0.81
SLSF114	Dessert Spoon	DOZEN	48.40	1	50	1.01
SLSF115	Iced Tea Spoon	DOZEN	39.16	1	50	0.75
SLSF116	Dinner Fork	DOZEN	44.44	1	50	0.69
SLSF117	Salad Fork	DOZEN	36.52	1	50	0.53
SLSF118	Oyster Fork	DOZEN	28.60	1	50	0.51
SLSF119	Dinner Knife	DOZEN	39.16	1	20	0.29
SLSF120	Table Spoon	DOZEN	68.20	1	50	1.52



STAINLESS STEEL



↓ 1.8 mm to
 ↑ 2.0 mm
 Thickness



SEA SHELL

A durable mirror finished, stainless steel flatware set, serves sweets or a full course meal with sea shell decoration handle.

ITEM	DESCRIPTION	U/M	WEIGHT GROSS lbs	INNER PACK	MASTER PACK	CU. FT.
SLSS001	Sugar Spoon	DOZEN	21.21	1	36	0.53
SLSS002	Teaspoon	DOZEN	40.22	1	36	0.56
SLSS003	Bouillon Spoon	DOZEN	41.17	1	36	0.67
SLSS004	Dessert Spoon	DOZEN	60.17	1	36	0.95
SLSS005	Iced Tea Spoon	DOZEN	39.27	1	36	0.74
SLSS006	Dinner Fork	DOZEN	46.87	1	36	0.68
SLSS007	Salad Fork	DOZEN	37.36	1	36	0.52
SLSS008	Oyster Fork	DOZEN	25.96	1	36	0.42
SLSS009	Dinner Knife	DOZEN	41.17	1	18	0.34
SLSS010	Table Spoon	DOZEN	41.64	1	18	0.67
SLSS011	Butter Knife	DOZEN	32.61	1	36	0.69



STAINLESS STEEL



↓ 2.5 mm to
 ↑ 3.0 mm
 Thickness

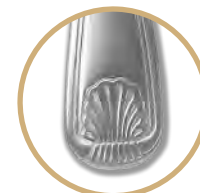



DOMILION

A durable shiny finished, stainless steel flatware set, serves sweets or a full course meal with simple line-trimmed handle.

ITEM	DESCRIPTION	U/M	WEIGHT GROSS lbs	INNER PACK	MASTER PACK	CU. FT.
Medium Weight (thickness range from 1.5 mm)						
SLDO001	Sugar Spoon	DOZEN	15.20	1	36	0.26
SLDO002	Teaspoon	DOZEN	22.16	1	36	0.38
SLDO003	Bouillon Spoon	DOZEN	24.06	1	36	0.50
SLDO004	Dessert Spoon	DOZEN	29.76	1	36	0.58
SLDO005	Iced Tea Spoon	DOZEN	24.06	1	36	0.51
SLDO006	Dinner Fork	DOZEN	25.01	1	36	0.38
SLDO007	Salad Fork	DOZEN	21.21	1	36	0.33
SLDO008	Oyster Fork	DOZEN	15.51	1	36	0.21
SLDO009	Dinner Knife	DOZEN	43.07	1	36	0.37
SLDO011	Table Spoon	DOZEN	45.92	1	36	0.90
Heavy Weight (thickness range from 2.5 mm)						
SLDO102	Teaspoon	DOZEN	38.58	1	50	0.53
SLDO103	Bouillon Spoon	DOZEN	37.92	1	50	0.63
SLDO104	Dessert Spoon	DOZEN	47.82	1	50	0.85
SLDO105	Iced Tea Spoon	DOZEN	43.20	1	50	0.74
SLDO106	Dinner Fork	DOZEN	44.52	1	50	0.60
SLDO107	Salad Fork	DOZEN	36.60	1	50	0.44
SLDO109	Dinner Knife	DOZEN	37.50	1	25	0.26

↓ 1.5 mm
↑ Thickness

↓ 2.5 mm to
↑ 3.0 mm
Thickness

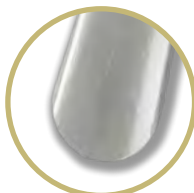

WINDSOR

A durable shiny finished, stainless steel flatware set, serves sweets or a full course meal with simple line-trimmed handle.

ITEM	DESCRIPTION	U/M	WEIGHT GROSS lbs	INNER PACK	MASTER PACK	CU. FT.
Medium Weight (thickness range from 1.5 mm)						
SLWD001	Sugar Spoon	DOZEN	13.60	1	36	0.26
SLWD002	Teaspoon	DOZEN	23.11	1	36	0.38
SLWD003	Bouillon Spoon	DOZEN	25.96	1	36	0.50
SLWD004	Dessert Spoon	DOZEN	28.81	1	36	0.58
SLWD005	Iced Tea Spoon	DOZEN	26.91	1	36	0.51
SLWD006	Dinner Fork	DOZEN	25.96	1	36	0.38
SLWD007	Salad Fork	DOZEN	20.26	1	36	0.33
SLWD008	Oyster Fork	DOZEN	14.56	1	36	0.21
SLWD009	Dinner Knife	DOZEN	42.12	1	36	0.37
SLWD011	Table Spoon	DOZEN	45.92	1	36	0.90
Heavy Weight (thickness range from 2.5 mm)						
SLWD102	Teaspoon	DOZEN	38.58	1	50	0.53
SLWD103	Bouillon Spoon	DOZEN	37.92	1	50	0.63
SLWD104	Dessert Spoon	DOZEN	47.82	1	50	0.85
SLWD105	Iced Tea Spoon	DOZEN	43.20	1	50	0.74
SLWD106	Dinner Fork	DOZEN	44.52	1	50	0.60
SLWD107	Salad Fork	DOZEN	36.60	1	50	0.44
SLWD109	Dinner Knife	DOZEN	37.50	1	25	0.26

↓ 1.5 mm
↑ Thickness

↓ 2.5 mm to
↑ 3.0 mm
Thickness



TRAY STAND

Folding chrome plated tray stand with 2 ribbon bars for supporting tras.
Folds neatly aside.

ITEM	DESCRIPTION	U/M	WEIGHT GROSS lbs	INNER PACK	MASTER PACK	CU. FT
WDTHS032	Double Bar, Mahogany Wood 17½" x 17" x 33½"	EACH	9.46	1	1	1.64
SLTS001	Folding Type, Chrome Plated 19" x 16½" x 30½"	EACH	28.66	1	6	3.25
SLTS002	Double Bar, Chrome Plated 19" x 17½" x 31½"	EACH	33.06	1	6	3.30



CHILDREN'S HIGH CHAIR

Stable wooden chair, with safety harness straps and wide stance to avoid tipping over.
**** SHIPS KNOCKED DOWN ****



ITEM	DESCRIPTION	U/M	WEIGHT GROSS lbs	INNER PACK	MASTER PACK	CU. FT.
WDTHHC018A	Natural Wood 20" x 22½" x 29½" Seat size: 10⅞" x 6⅔"	EACH	11.9	1	1	0.72
WDTHHC019A	Walnut Wood 20" x 22½" x 29½" Seat size: 10⅞" x 6⅔"	EACH	11.9	1	1	0.72
WDTHHC020A	Mahogany Wood 20" x 22½" x 29½" Seat size: 10⅞" x 6⅔"	EACH	11.9	1	1	0.72



CHILDREN'S WOOD BOOSTER SEAT

Stable wooden booster, with safety harness straps.
**** SHIPS KNOCKED DOWN ****

ITEM	DESCRIPTION	U/M	WEIGHT GROSS lbs	INNER PACK	MASTER PACK	CU. FT.
WDTHBS018	Natural Wood 11⅞" x 11⅞" x 10⅞", Seat back support: Maximum 17"	EACH	46.20	1	6	1.94
WDTHBS019	Walnut Finish Wood 11⅞" x 11⅞" x 10⅞", Seat back support: Maximum 17"	EACH	46.20	1	6	1.94
WDTHBS020	Mahogany Finish Wood 11⅞" x 11⅞" x 10⅞", Seat back support: Maximum 17"	EACH	46.20	1	6	1.94



Stackable



WDTHBS018



WDTHBS019



WDTHBS020

INFORMATION SIGN WITH SYMBOLS

6" x 9" information sign with symbol.

U/M	WEIGHT GROSS lbs	INNER PACK	MASTER PACK	CU. FT.
EACH	20.13	12	72	0.77



Easy peel self-adhesive backing.



PLIS6901BK PLIS6902BK PLIS6903BL PLIS6904RD PLIS6905RD PLIS6906RD PLIS6907RD



PLIS6908BK PLIS6909BL PLIS6910RD PLIS6911BL PLIS6912BK PLIS6913RD PLIS6914BL

ITEM	DESCRIPTION
PLIS6901BK	"We Are Pleased to Provide All Our Guests A Smoke-Free Environment"
PLIS6902BK	"Smoking Area"
PLIS6903BL	"Restroom/Accessible"
PLIS6904RD	"In Case of Fire Do Not Use Elevator Use Stairwell"
PLIS6905RD	"No Smoking Area"
PLIS6906RD	"Smoking Area"
PLIS6907RD	"Exit"
PLIS6908BK	"Restrooms"
PLIS6909BL	"Women/ Accessible"
PLIS6910RD	"No Smoking Area Available"
PLIS6911BL	"Accessible"
PLIS6912BK	"No Smoking"
PLIS6913RD	"Fire Extinguisher"
PLIS6914BL	"Men/ Accessible"

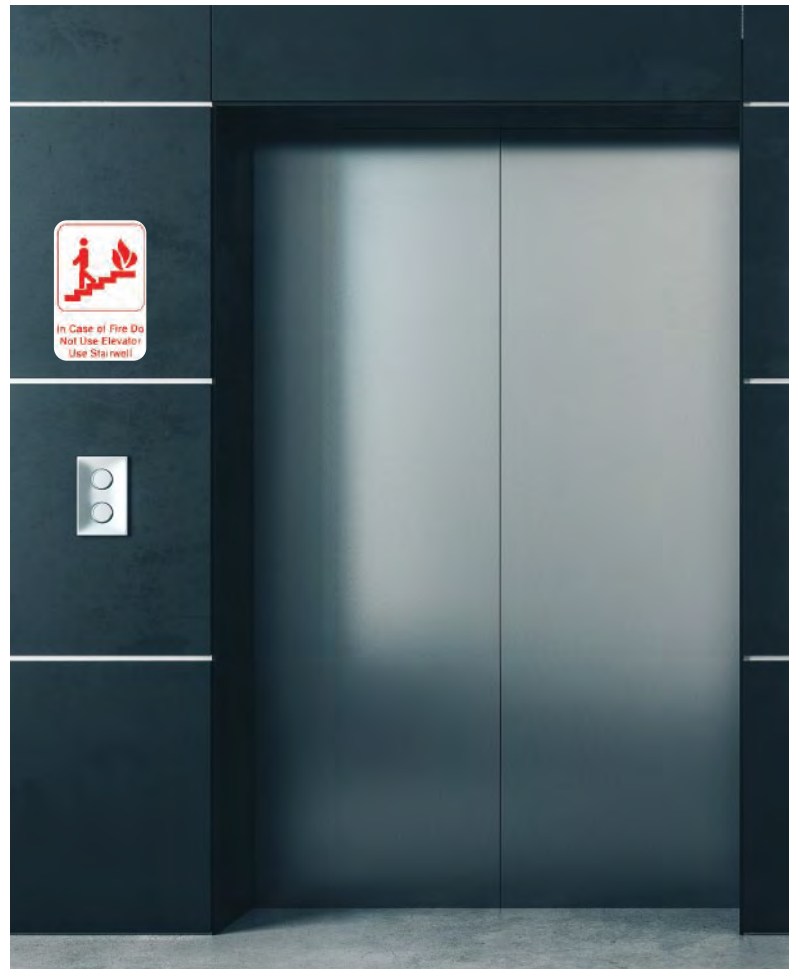

RAISED INFORMATION SIGN WITH SYMBOLS AND BRAILLE

6" x 9" Information sign with braille and self adhesive backing for easy mounting.



Easy peel self-adhesive backing.

U/M	WEIGHT GROSS lbs	INNER PACK	MASTER PACK	CU. FT.
EACH	20.92	6	72	0.68



PLIS6951BK



PLIS6952BK



PLIS6953BK



PLIS6954BK



PLIS6955BK



PLIS6956BK



PLIS6957BL



PLIS6958BL



PLIS6959BL



PLIS6960BL



PLIS9601BK



ITEM	DESCRIPTION
PLIS6951BK	"Women"
PLIS6952BK	"Men"
PLIS6953BK	"Restroom"
PLIS6954BK	"Stairs"
PLIS6955BK	"No Smoking"
PLIS6956BK	"Exit"
PLIS6957BL	"Women/Accessible"
PLIS6958BL	"Men/Accessible"
PLIS6959BL	"Accessible"
PLIS6960BL	"Restroom/Accessible"
PLIS9601BK	"Family Restroom/Accessible"



INFORMATION SIGN WITH SYMBOL

9" x 3" information sign with symbols.

U/M	WEIGHT GROSS lbs	INNER PACK	MASTER PACK	CU. FT.
EACH	20.13	12	144	0.77



Easy peel
self-adhesive
backing.

1/8" Thickness



PLIS9301BK



PLIS9302BK



PLIS9303BK

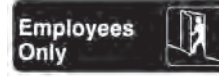

PLIS9304BK



PLIS9305BK



PLIS9306BK



PLIS9307RD



PLIS9308BK



PLIS9309BK



PLIS9310BK



PLIS9311BK



PLIS9312BK



PLIS9313BK



PLIS9314BK



PLIS9315BK



PLIS9316RD



PLIS9317BK



PLIS9318BK



PLIS9319BK



PLIS9320BK

ITEM	DESCRIPTION
PLIS9301BK	"Push"
PLIS9302BK	"Pull"
PLIS9303BK	"Private"
PLIS9304BK	"Employees Only"
PLIS9305BK	"No Admittance"
PLIS9306BK	"No Exit"
PLIS9307RD	"Exit"
PLIS9308BK	"Out"
PLIS9309BK	"In"
PLIS9310BK	"Entrance"
PLIS9311BK	"No Smoking"
PLIS9312BK	"Smoking Permitted"
PLIS9313BK	"Men"
PLIS9314BK	"Women"
PLIS9315BK	"Restrooms"
PLIS9316RD	"Fire Extinguisher"
PLIS9317BK	"No Checks Please"
PLIS9318BK	"Thank You For Not Smoking"
PLIS9319BK	"No Pets/Shoes, Shirt Required"
PLIS9320BK	"This is a Smoke-Free Restaurant"



INFORMATION SIGN WITH SYMBOL

9" x 3" information sign with symbols.

U/M	WEIGHT GROSS lbs	INNER PACK	MASTER PACK	CU. FT.
EACH	20.13	12	144	0.77



Easy peel self-adhesive backing.

1/8" Thickness

9"

3"

Restrooms For Customer Use Only PLIS9321BK	No Soliciting PLIS9322BK	Office PLIS9323BK	WASH PLIS9341BK
Employees Must Wash Hands Before Returning To Work PLIS9325BK	Not Responsible For Lost Or Stolen Articles PLIS9326BK	Smoking Permitted In Designated Area Only PLIS9327BK	Microwave Oven In Operation PLIS9324BK
Caution Watch Your Step PLIS9329BK	No Shirt No Shoes No Service PLIS9330BK	No Food or Drink PLIS9331BK	Telephone PLIS9328BK
HAND WASH ONLY PLIS9333BK	PLEASE LET US KNOW IF THE RESTROOM NEEDS ATTENTION PLIS9334BK	NO PUBLIC RESTROOMS PLIS9335BK	WIFI PLIS9336BK
No E-Cigarettes PLIS9337BK	RESERVED PLIS9337BK	RINSE PLIS9339BK	SANITIZE PLIS9340BK

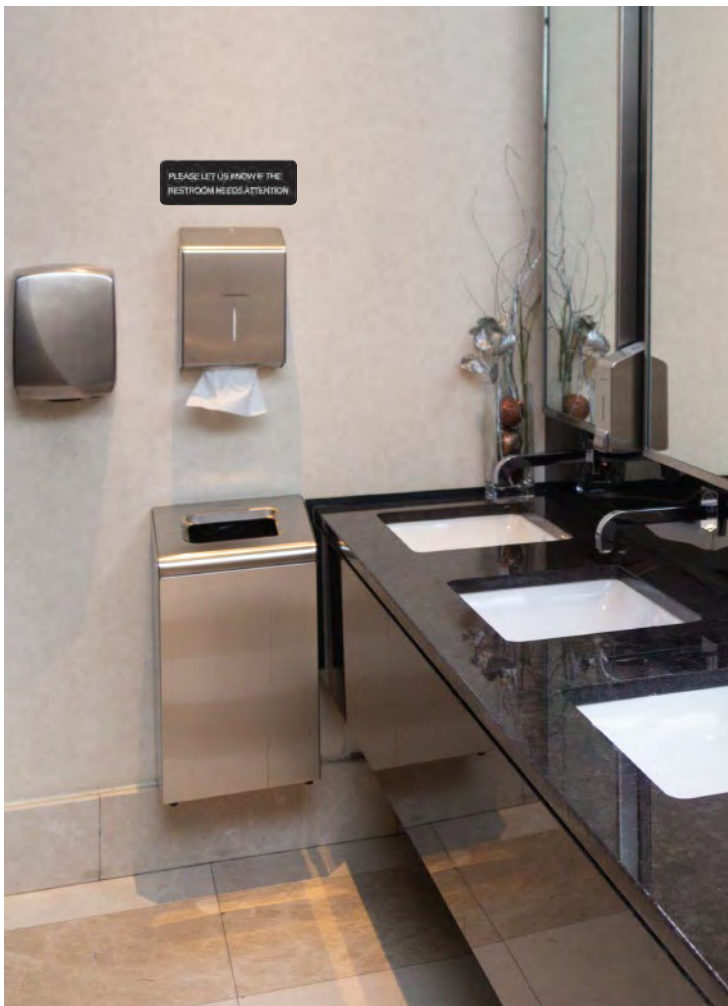

ITEM	DESCRIPTION
PLIS9321BK	"Restrooms For Customer Use Only"
PLIS9322BK	"No Soliciting"
PLIS9323BK	"Office"
PLIS9324BK	"Microwave Oven in Operation"
PLIS9325BK	"Employees Must Wash Hands Before Returning to Work"
PLIS9326BK	"Not Responsible for Lost Or Stolen Articles"
PLIS9327BK	"Smoking Permitted in Designated Area Only"
PLIS9328BK	"Telephone"
PLIS9329BK	"Caution, Watch Your Step"
PLIS9330BK	"No Shirt, No Shoes, No Service"
PLIS9331BK	"No Food or Drink"
PLIS9332BK	"No Cell Phone Use, Please"
PLIS9333BK	"Hand Wash Only"
PLIS9334BK	"Please Let Us Know If the Restroom Needs Attention"
PLIS9335BK	"No Public Restrooms"
PLIS9336BK	"WIFI"
PLIS9337BK	"No E-Cigarettes"
PLIS9338BK	"RESERVED"
PLIS9339BK	"RINSE"
PLIS9340BK	"SANITIZE"
PLIS9341BK	"WASH"



COMMERCIAL WIRE SHELVING - CHROME PLATED

Chrome plated wire shelving. Adjustable legs for leveling on uneven surfaces.

****Each shelf maximum capacity is 150 lbs per shelf on casters.****



ITEM	DESCRIPTION	SHELF WEIGHT CAPACITY	U/M	WEIGHT GROSS lbs	INNER PACK	MASTER PACK	CU. FT.
Shelf w/ 4 Set of Sleeve Clips							
CMSV1424	14" x 24"	850 lbs	EACH	11.68	2	2	0.80
CMSV1430	14" x 30"	850 lbs	EACH	14.11	2	2	0.99
CMSV1436	14" x 36"	850 lbs	EACH	16.53	2	2	1.18
CMSV1448	14" x 48"	850 lbs	EACH	21.61	2	2	1.57
CMSV1460	14" x 60"	600 lbs	EACH	26.68	2	2	1.96
CMSV1472	14" x 72"	600 lbs	EACH	31.31	2	2	2.34
CMSV1824	18" x 24"	850 lbs	EACH	13.23	2	2	1.01
CMSV1830	18" x 30"	850 lbs	EACH	16.09	2	2	1.25
CMSV1836	18" x 36"	850 lbs	EACH	18.74	2	2	1.50
CMSV1842	18" x 42"	850 lbs	EACH	21.61	2	2	1.75
CMSV1848	18" x 48"	850 lbs	EACH	24.25	2	2	1.99
CMSV1854	18" x 54"	600 lbs	EACH	26.90	2	2	2.24
CMSV1860	18" x 60"	600 lbs	EACH	29.76	2	2	2.49
CMSV1872	18" x 72"	600 lbs	EACH	34.83	2	2	2.98
CMSV2124	21" x 24"	850 lbs	EACH	14.44	2	2	1.18
CMSV2130	21" x 30"	850 lbs	EACH	17.53	2	2	1.46
CMSV2136	21" x 36"	850 lbs	EACH	20.39	2	2	1.74
CMSV2142	21" x 42"	850 lbs	EACH	23.26	2	2	2.03
CMSV2148	21" x 48"	850 lbs	EACH	26.12	2	2	2.21
CMSV2154	21" x 54"	600 lbs	EACH	28.99	2	2	2.61
CMSV2160	21" x 60"	600 lbs	EACH	32.08	2	2	2.89
CMSV2172	21" x 72"	600 lbs	EACH	37.59	2	2	3.46
CMSV2424	24" x 24"	850 lbs	EACH	16.53	2	2	1.33
CMSV2430	24" x 30"	850 lbs	EACH	19.84	2	2	1.65
CMSV2436	24" x 36"	850 lbs	EACH	22.93	2	2	1.98
CMSV2442	24" x 42"	850 lbs	EACH	26.23	2	2	2.31
CMSV2448	24" x 48"	850 lbs	EACH	29.54	2	2	2.63
CMSV2454	24" x 54"	600 lbs	EACH	32.85	2	2	2.97
CMSV2460	24" x 60"	600 lbs	EACH	39.24	2	2	3.29
CMSV2472	24" x 72"	600 lbs	EACH	46.08	2	2	3.94
Post w/ Leveling Foot							
CMPC008	8" Post		EACH	1.98	4	4	0.04
CMPC034	34" Post		EACH	6.17	4	4	0.13
CMPC063	63" Post		EACH	11.00	4	4	0.24
CMPC072	74" Post		EACH	13.18	4	4	0.28
CMPC086	86" Post		EACH	15.65	4	4	0.33

* Sold by Master Pack Only.



Chrome Shelves



Posts



Leveling Foot Included



Sleeve Clips

COMMERCIAL WIRE SHELVING - EPOXY COATED

Epoxy coated wire shelving endures in moist areas. Adjustable legs for leveling on uneven surfaces.

****Each shelf maximum capacity is 150 lbs per shelf on casters.****



ITEM	DESCRIPTION	SHELF WEIGHT CAPACITY	U/M	WEIGHT GROSS lbs	INNER PACK	MASTER PACK	CU. FT.
Shelf w/ 4 Set of Sleeve Clips							
CMEP1424	14" x 24"	850 lbs	EACH	11.68	2	2	0.80
CMEP1430	14" x 30"	850 lbs	EACH	14.11	2	2	0.99
CMEP1436	14" x 36"	850 lbs	EACH	16.53	2	2	1.18
CMEP1448	14" x 48"	850 lbs	EACH	21.61	2	2	1.57
CMEP1460	14" x 60"	600 lbs	EACH	26.68	2	2	1.96
CMEP1472	14" x 72"	600 lbs	EACH	31.31	2	2	2.34
CMEP1824	18" x 24"	850 lbs	EACH	13.23	2	2	1.01
CMEP1830	18" x 30"	850 lbs	EACH	16.09	2	2	1.25
CMEP1836	18" x 36"	850 lbs	EACH	18.74	2	2	1.50
CMEP1842	18" x 42"	850 lbs	EACH	21.61	2	2	1.75
CMEP1848	18" x 48"	850 lbs	EACH	24.25	2	2	1.99
CMEP1854	18" x 54"	600 lbs	EACH	26.90	2	2	2.24
CMEP1860	18" x 60"	600 lbs	EACH	29.76	2	2	2.49
CMEP1872	18" x 72"	600 lbs	EACH	34.83	2	2	2.98
CMEP2124	21" x 24"	850 lbs	EACH	14.44	2	2	1.18
CMEP2130	21" x 30"	850 lbs	EACH	17.53	2	2	1.46
CMEP2136	21" x 36"	850 lbs	EACH	20.39	2	2	1.74
CMEP2142	21" x 42"	850 lbs	EACH	23.26	2	2	2.03
CMEP2148	21" x 48"	850 lbs	EACH	26.12	2	2	2.21
CMEP2154	21" x 54"	600 lbs	EACH	28.99	2	2	2.61
CMEP2160	21" x 60"	600 lbs	EACH	32.08	2	2	2.89
CMEP2172	21" x 72"	600 lbs	EACH	37.59	2	2	3.46
CMEP2424	24" x 24"	850 lbs	EACH	16.53	2	2	1.33
CMEP2430	24" x 30"	850 lbs	EACH	19.84	2	2	1.65
CMEP2436	24" x 36"	850 lbs	EACH	22.93	2	2	1.98
CMEP2442	24" x 42"	850 lbs	EACH	26.23	2	2	2.31
CMEP2448	24" x 48"	850 lbs	EACH	29.54	2	2	2.63
CMEP2454	24" x 54"	600 lbs	EACH	32.85	2	2	2.97
CMEP2460	24" x 60"	600 lbs	EACH	39.24	2	2	3.29
CMEP2472	24" x 72"	600 lbs	EACH	46.08	2	2	3.94
Post w/ Leveling Foot							
CMEC008	8" Post		EACH	1.98	4	4	0.04
CMEC034	34" Post		EACH	6.17	4	4	0.13
CMEC063	63" Post		EACH	11.02	4	4	0.24
CMEC072	74" Post		EACH	13.18	4	4	0.28
CMEC086	86" Post		EACH	15.65	4	4	0.33

*** Sold by Master Pack Only.**

Sleeve Clips



Leveling Foot Included



Posts

Green Epoxy Shelves



SHELVING ACCESSORIES

Wheels available with locking and non locking feature, 198 lbs. capacity.



ITEM	DESCRIPTION	U/M	WEIGHT GROSS lbs	INNER PACK	MASTER PACK	CU. FT.
Accessories						
ALFN001	Shelving Knob for Post, 1" x 1"	EACH	39.46	4	500	0.71
ALFP001	Foot Plate, 2 $\frac{3}{8}$ " x 2 $\frac{1}{8}$ " x 1 $\frac{1}{8}$ "	EACH	45.15	1	500	1.41
ALFP002	Post Clamp, 3 $\frac{1}{4}$ " x 7 $\frac{1}{8}$ " x 1 $\frac{3}{8}$ "	EACH	67.18	1	500	0.88
ALSH001	S Hook, 1 $\frac{3}{8}$ " x 5 $\frac{1}{8}$ " x 1"	EACH	27.53	1	500	0.71
ALSH001EP	S Hook, Green Epoxy, 1 $\frac{3}{8}$ " x 5 $\frac{1}{8}$ " x 1"	EACH	25.73	4	500	0.71
PLDLF001	Leveling Foot, 1" x 1" x 2"	EACH	39.46	4	500	0.71
PLRPSS	Split Sleeve Shelf Clips, 2pc/set 1 $\frac{1}{2}$ " x 1 $\frac{1}{8}$ " x 1 $\frac{3}{8}$ "	SET	9.14	4	500	1.13



ITEM	DESCRIPTION	U/M	WEIGHT GROSS lbs	INNER PACK	MASTER PACK	CU. FT.
Rubber Wheel						
PLCB5140	5": 5 $\frac{1}{2}$ " x 2 $\frac{1}{4}$ " x 7 $\frac{3}{4}$ ", Wheel size: 5" Diameter x 1 $\frac{1}{4}$ " Width	EACH	51.81	1	18	0.97
PLCB5140B	5" with Brake: 5 $\frac{1}{2}$ " x 3 $\frac{1}{2}$ " x 7 $\frac{3}{4}$ ", Wheel size: 5" Diameter x 1 $\frac{1}{4}$ " Width	EACH	50.71	1	16	0.97
PLCB3140	3": 3 $\frac{1}{8}$ " x 2" x 5 $\frac{1}{8}$ ", Wheel size: 3" Diameter x 1" Width	EACH	22.58	1	24	0.28
PLCB3140B	3" with Brake: 3 $\frac{1}{8}$ " x 2" x 5 $\frac{1}{8}$ ", Wheel size: 3" Diameter x 1" Width	EACH	25.35	1	24	0.35

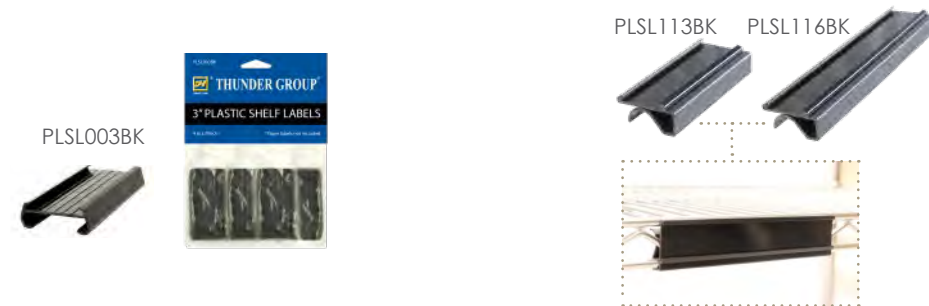

ITEM	DESCRIPTION	U/M	WEIGHT GROSS lbs	INNER PACK	MASTER PACK	CU. FT.
Plastic Shelf Label, Black						
PLSL003BK	3", 4pcs/pack: 3" x 1 $\frac{3}{8}$ " x 5 $\frac{1}{8}$ ", Label Size: 3 $\frac{1}{8}$ " x 1"	PACK	24.65	1	250	2.43
PLSL006BK	6", 4pcs/pack: 6" x 1 $\frac{3}{8}$ " x 5 $\frac{1}{8}$ ", Label Size: 6" x 1"	PACK	22.00	1	125	2.25
PLSL113BK	3" Snap-Under Shelf Label, 4pcs/pack, 3" x 1 $\frac{3}{8}$ " x 5 $\frac{1}{8}$ "	PACK	35.00	1	250	2.43
PLSL116BK	6" Snap-Under Shelf Label, 4pcs/pack, 6" x 1 $\frac{3}{8}$ " x 5 $\frac{1}{8}$ "	PACK	35.00	1	125	2.25



SHELVING PARTS

ITEM	DESCRIPTION	U/M	WEIGHT GROSS lbs	INNER PACK	MASTER PACK	CU. FT.
Chrome Plated, Wall Bracket						
Single						
WBSV014	14" x 2 $\frac{5}{8}$ " x 7 $\frac{3}{4}$ "	EACH	6.61	1	4	0.36
WBSV018	18" x 2 $\frac{1}{2}$ " x 7 $\frac{3}{4}$ "	EACH	8.82	1	4	0.50
WBSV021	21" x 3" x 7 $\frac{1}{4}$ "	EACH	9.26	1	4	0.53
WBSV024	24" x 2 $\frac{1}{2}$ " x 7 $\frac{1}{8}$ "	EACH	9.92	1	4	0.60
Double						
WBSV214	14" x 11 $\frac{1}{4}$ " x 1 $\frac{1}{2}$ "	EACH	13.23	1	4	0.67
WBSV218	18" x 11 $\frac{1}{4}$ " x 1 $\frac{1}{2}$ "	EACH	17.02	1	4	0.88
WBSV221	21" x 11 $\frac{1}{4}$ " x 1 $\frac{1}{2}$ "	EACH	17.90	1	4	0.99
WBSV224	24" x 11 $\frac{1}{4}$ " x 1 $\frac{1}{2}$ "	EACH	19.22	1	4	1.06
Chrome Plated Shelf Divider						
CMDC014	14" Pressure-fit: 14" x 2 $\frac{1}{8}$ " x 9 $\frac{5}{8}$ "	EACH	11.38	1	12	0.71
CMDC018	18" Pressure-fit: 18" x 2 $\frac{1}{8}$ " x 9 $\frac{3}{8}$ "	EACH	16.40	1	12	0.85
CMDC021	21" Pressure-fit: 21" x 2 $\frac{1}{8}$ " x 9 $\frac{1}{2}$ "	EACH	17.72	1	12	0.99
CMDC024	24" Pressure-fit: 24" x 2 $\frac{1}{8}$ " x 9 $\frac{1}{2}$ "	EACH	20.11	1	12	1.10
Chrome Plated Cart Extended Handle						
CMCH014	14": 14" x 5 $\frac{3}{4}$ " x 1 $\frac{3}{8}$ "	EACH	13.01	1	12	0.82
CMCH018	18": 18" x 5 $\frac{3}{4}$ " x 1 $\frac{3}{8}$ "	EACH	17.42	1	12	1.04
CMCH021	21": 21" x 5 $\frac{3}{4}$ " x 1 $\frac{3}{8}$ "	EACH	18.30	1	12	1.21
CMCH024	24": 24" x 5 $\frac{3}{4}$ " x 1 $\frac{3}{8}$ "	EACH	18.96	1	12	1.84



ITEM	DESCRIPTION	U/M	WEIGHT GROSS lbs	INNER PACK	MASTER PACK	CU. FT.
Green Epoxy Coated, Wall Bracket						
Single						
WBEP014	14" : 14" x 2 $\frac{5}{8}$ " x 7 $\frac{3}{4}$ "	EACH	6.61	1	4	0.36
WBEP018	18" : 18" x 2 $\frac{1}{2}$ " x 7 $\frac{3}{4}$ "	EACH	8.82	1	4	0.50
WBEP021	21" : 21" x 3" x 7 $\frac{1}{4}$ "	EACH	9.26	1	4	0.53
WBEP024	24" : 24" x 2 $\frac{1}{2}$ " x 7 $\frac{1}{8}$ "	EACH	9.92	1	4	0.60
Double						
WBEP214	14" : 14" x 11 $\frac{1}{4}$ " x 1 $\frac{1}{2}$ "	EACH	13.23	1	4	0.67
WBEP218	18" : 18" x 11 $\frac{1}{4}$ " x 1 $\frac{1}{2}$ "	EACH	17.02	1	4	0.88
WBEP221	21" : 21" x 11 $\frac{1}{4}$ " x 1 $\frac{1}{2}$ "	EACH	17.90	1	4	0.99
WBEP224	24" : 24" x 11 $\frac{1}{4}$ " x 1 $\frac{1}{2}$ "	EACH	19.22	1	4	1.06
Green Epoxy Coated, Shelf Divider						
CMDE014	14" Pressure-fit, 14" x 2 $\frac{1}{8}$ " x 9 $\frac{5}{8}$ "	EACH	11.38	1	12	0.71
CMDE018	18" Pressure-fit, 18" x 2 $\frac{1}{8}$ " x 9 $\frac{3}{8}$ "	EACH	16.40	1	12	0.85
CMDE021	21" Pressure-fit, 21" x 2 $\frac{1}{8}$ " x 9 $\frac{1}{2}$ "	EACH	17.72	1	12	0.99
CMDE024	24" Pressure-fit, 24" x 2 $\frac{1}{8}$ " x 9 $\frac{1}{2}$ "	EACH	20.11	1	12	1.10

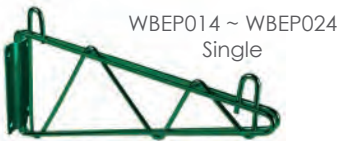



SLWT42484F

* Ships Knocked Down *
 * Shipped Freight Only *
 * No UPS *



Curved Edges



Adjustable Feet

STAINLESS STEEL WORKTABLE - FLAT TOP

Stainless steel worktable surface has curved edges for safety and comfort. It incorporates a heavy duty adjustable galvanized under shelf and leveling feet. Heavy duty 5" Casters are available and sold separately.



ITEM	DESCRIPTION	U/M	WEIGHT GROSS lbs	INNER PACK	MASTER PACK	CU. FT.
SLWT42412F	24" x 12" x 35"	SET	28.60	1	1	1.38
SLWT42418F	24" x 18" x 35"	SET	33.00	1	1	1.87
SLWT42424F	24" x 24" x 35"	SET	37.40	1	1	2.36
SLWT42430F	24" x 30" x 35"	SET	41.80	1	1	2.36
SLWT42436F	24" x 36" x 35"	SET	46.20	1	1	1.92
SLWT42448F	24" x 48" x 35"	SET	55.00	1	1	2.53
SLWT42460F	24" x 60" x 35"	SET	66.00	1	1	3.15
SLWT42472F	24" x 72" x 35"	SET	74.80	1	1	3.76
SLWT42484F*	24" x 84" x 35"	SET	90.20	1	1	4.38
SLWT42496F*	24" x 96" x 35"	SET	99.00	1	1	4.99
SLWT43012F	30" x 12" x 35"	SET	30.80	1	1	1.38
SLWT43018F	30" x 18" x 35"	SET	36.30	1	1	1.87
SLWT43024F	30" x 24" x 35"	SET	41.80	1	1	2.36
SLWT43030F	30" x 30" x 35"	SET	47.30	1	1	2.85
SLWT43036F	30" x 36" x 35"	SET	52.80	1	1	2.37
SLWT43048F	30" x 48" x 35"	SET	66.00	1	1	3.14
SLWT43060F	30" x 60" x 35"	SET	77.00	1	1	3.90
SLWT43072F	30" x 72" x 35"	SET	88.00	1	1	4.66
SLWT43084F*	30" x 84" x 35"	SET	105.60	1	1	5.42
SLWT43096F*	30" x 96" x 35"	SET	118.80	1	1	6.19

SLWT42424F



SLWT42448F



* 84" and 96" models have 6 legs for extra strength and support.



* Ships Knocked Down *
 * Shipped Freight Only *
 * No UPS *

SLWT42484F4

WORKTABLE, FLAT TOP WITH 4" BACKSPASH

Stainless steel heavy duty worktable with backsplash. Suitable for commercial kitchen.



ITEM	DESCRIPTION	U/M	WEIGHT GROSS lbs	INNER PACK	MASTER PACK	CU. FT.
SLWT42448F4	24" x 48" x 35"	SET	56.15	1	1	6.06
SLWT42460F4	24" x 60" x 35"	SET	66.07	1	1	7.48
SLWT42472F4	24" x 72" x 35"	SET	76.06	1	1	8.94
SLWT42484F4*	24" x 84" x 35"	SET	92.95	1	1	10.38
SLWT42496F4*	24" x 96" x 35"	SET	102.80	1	1	11.83
SLWT43048F4	30" x 48" x 35"	SET	64.86	1	1	7.43
SLWT43060F4	30" x 60" x 35"	SET	85.69	1	1	9.17
SLWT43072F4	30" x 72" x 35"	SET	88.93	1	1	10.97
SLWT43084F4*	30" x 84" x 35"	SET	107.83	1	1	12.73
SLWT43096F4*	30" x 96" x 35"	SET	119.89	1	1	14.51



Curved Edges



1" Adjustable Feet



4" Backsplash

WORKTABLE CASTER



ITEM	DESCRIPTION	U/M	WEIGHT GROSS lbs	INNER PACK	MASTER PACK	CU. FT.
SLWTC005	5"	EACH	36.76	1	16	0.90
SLWTC005B	5" with Brake	EACH	41.75	1	16	0.90



Brake Close Up



Stem Close Up



CONVERSION CHART

LINEAR MEASUREMENT

1 mil	=	0.001 inch	=	0.0254 millimeter
1 inch	=	1,000 mils	=	2.54 centimeter
12 inch	=	1 foot	=	0.3048 meter
3 feet	=	1 yard	=	0.9144 meter

SQUARE MEASUREMENT

-	=	1 sq inch	=	6,452 sq centimeter
144 sq inch	=	1 sq foot	=	929.03 sq centimeter
1296 sq inch	=	1 sq yard	=	0.83161 sq meter

CUBIC MEASUREMENT

-	=	1 cubic inch	=	16.387 cubic centimeter
1728 cubic inches	=	1 cubic foot	=	0.0283 cubic meter
27 cubic feet	=	1 cubic yard	=	0.7646 cubic meter

DRY MEASUREMENT

1 pint	=	33.6 cubic inches	=	0.5506 liter
2 pint (1 quart)	=	67.2 cubic inches	=	1.1012 liter
8 quart	=	537.61 cubic inches	=	8.8098 liter

LIQUID MEASUREMENT

1 fluid oz	=	1.805 cubic inches	=	29.57 ml
4 fluid oz	=	7.219 cubic inches	=	0.1183 liter
1 pint	=	28.875 cubic inches	=	0.4732 liter
2 pint (1 quart)	=	57.75 cubic inches	=	0.9464 liter
4 pint (2 quart)	=	115.5 cubic inches	=	1.8927 liter

AVOIRDUPOIS MEASUREMENT

1 oz	=	0.0625 lbs	=	28.3495 grams
16 oz	=	1 lb	=	453.59 grams
100lbs	=	1 hundred-weight	=	45.36 grams
2000lbs	=	1 Short ton	=	907.18 kg

CONVERSION

Inches x 25.4 = mm	=	1.805 cubic inches	=	29.57 ml
Inches x 2.54 = cm	=	7.219 cubic inches	=	0.1183 liter
mm x 0.03937 =	=	28.875 cubic inches	=	0.4732 liter
2 pint (1 quart)	=	57.75 cubic inches	=	0.9464 liter
4 pint (2 quart)	=	231 cubic inches	=	3.7854 liter

CONVERSION CHART

ALUMINUM GAUGE CONVERSION CHART

INCHES	DECIMAL	mm	GAUGE
1/64	0.1526	-	-
-	0.0201	-	24
-	0.0226	-	23
-	0.0253	-	22
-	0.0285	-	21
1/32	0.03125	0.794	-
-	0.03125	0.800	-
-	0.020	-	20
-	0.0359	-	19
-	0.03937	1.000	-
-	0.0403	-	18
-	0.0453	-	17
3/64	0.046875	1.190	-
-	0.0508	-	16
-	0.0571	-	15
1/16	0.0625	1.587	-
-	0.063	-	-
-	0.0641	-	14
-	0.0720	-	13
5/64	0.078125	1.984	-
-	0.07874	2.000	-
-	0.0808	-	12
-	0.0907	-	11
3/32	0.09375	2.381	-
-	0.098425	2.500	-
-	0.1019	-	10
7/64	0.109375	2.778	-
-	0.1144	-	9
-	0.11811	3.000	-
-	0.1250	3.175	-
-	0.1285	-	8
-	0.137795	3.500	-
9/64	0.140625	3.571	-
-	0.1443	-	7
5/32	0.15625	3.968	-
-	0.15748	4.000	6.25
-	0.1620	-	6
11/64	0.171875	4.365	-
-	0.177165	4.5000	-
-	0.1819	-	5
3/16	0.1875	4.762	-
-	0.19685	5.000	-
13/64	0.203125	5.159	-
-	0.2043	-	4
-	0.216535	5.500	-
7/32	0.21875	5.556	-
-	0.2294	-	3
15/64	0.234375	5.953	-
-	0.23622	6.000	-
1/4	0.250	6.350	-
-	0.2576	-	2
-	0.2893	-	1

STAINLESS STEEL GAUGE CONVERSION CHART

INCHES	DECIMAL	mm	GAUGE
1/64	0.15265	-	28
-	0.015625	-	-
-	0.015748	0.396	-
-	0.0179	0.4	26
-	0.0209	-	25
-	0.023622	0.6	-
-	0.0239	-	24
-	0.0269	-	23
-	0.027559	0.7	-
-	0.0299	-	22
1/32	0.03125	0.794	-
-	0.031496	0.8	-
-	0.0329	-	21
-	0.035433	0.9	-
-	0.0359	-	20
-	0.03937	1.0	-
-	0.0418	-	19
3/64	0.0465875	1.19	-
-	0.047244	1.2	-
-	0.0478	-	18
-	0.0538	-	17
-	0.059055	1.5	-
-	0.0598	-	16
1/16	0.0625	1.567	-
-	0.0673	-	15
-	0.0747	-	14
5/64	0.078125	1.984	-
-	0.07874	2.0	-
-	0.086614	2.2	-
-	0.0897	-	13
-	0.09375	2.381	-
-	0.094488	2.4	-
-	0.098425	2.5	-
-	0.1046	-	12
-	0.106299	2.7	-
7/64	0.109375	2.778	-
-	0.11811	3.0	-
-	0.1196	-	11
1/8	0.125	3.175	-
-	0.1345	-	10
-	0.1495	-	9
5/32	0.15625	3.968	-
-	0.15748	4.000	-
-	0.1644	-	8
-	0.1793	-	7
3/16	0.1875	4.762	-
-	0.188976	4.8	-
-	0.192913	4.9	-
-	0.1793	-	6
13/64	0.203125	5.159	-
-	0.2092	-	5
-	0.23622	-	4
-	0.23622	6.0	-
-	0.2391	-	3
1/4	0.250	6.5	-

Catalog Icon Legend

NEW

New for 2024



Shatter Resistant



Dishwasher Safe



Break Resistant



Not for Dishwasher



Not for Oven



Not for Microwave

18/10 **SS** STAINLESS STEEL

Made of 18/10 Stainless Steel

18/8 **SS** STAINLESS STEEL

Made of 18/8 Stainless Steel

SS STAINLESS STEEL

A ALUMINUM

G GALVANIZED

PP POLYPROPYLENE

PC POLYCARBONATE



No electricity needed



UL Certified



UL Certified US



ETL Certified



ETL Certified US



ASTM 404 Certified



NSF Certified



CSA Certified



High-density Polyethylene & Recycled No. 2



Induction Ready



Halogen Ready



Gas Ready



Electric Ready



Heavy Duty



Heavy Weight



This item is temperature safe from -40 to 210° F



This item is temperature safe from -40 to 160° F



Sold as Master Pack only

12 TRUE GAUGE

16 TRUE GAUGE

18 TRUE GAUGE

20 TRUE GAUGE

22 TRUE GAUGE

24 TRUE GAUGE

25 TRUE GAUGE



Food/ Liquid Hold Time:
Time Food/ Liquid will keep their temperature



Airpots:
Bottom of base rotates



Thunder Group Inc.
Warranty



Thunder Group Inc.
Patented Item



Rinnai

All product names, logos, brands, trademarks and registered trademarks are property of their respective owners.

Index By Item Number

Item #	Page #
29	191
30	191
53	191
1704	151
1707	148
1708	148
1710	148
1712	148
1806	148
1807	148
1808	148
1810	148
1812	148
1814	148
1816	148
1901	168
1902	168
1903	168
1904	168
1905	168
1906	168
1907	167
1908	167
1909	167
1910	167
1911	167
1912	167
1913	167
1914	167
1915	167
1916	167
1940	168
1945	168
1960	168
2308	162
2309	162
2311	162
2404	149
2406	149
2408	149
2412	149
2414	149
2416	149
2907	167
2908	167
2909	167
2910	167
2911	167
2912	167
2913	167
2914	167
2916	167

Item #	Page #
3601	151
3703	151
3704	149
3705	150
3706	149
3707	149
3904	168
3905	168
3906	168
3935	168
3945	168
3955	168
3960	168
3965	168
5705	150
5706	150
5707	150
5770	150
5780	150
5904	168
5975	168
5980	168
5990	168
9007	244
9154	168
9752	151
9952	168
0001BB	145
0001J	165
0002BB	145
0002J	165
0010BB	142
0010J	162
0011BB	141
0011J	162
0900BB	141
0900J	162
0901BB	142
0901J	162
0902BB	142
0902J	162
0903BB	142
0903J	162
1000CFB	196
1000CFG	196
1000CFR	196
1002BB	145
1002J	165
1003AR	138
1003DL	109
1003TB	126
1003TP	132

Item #	Page #
1003TR	120
1003TW	114
1004AR	138
1004DL	109
1004TB	126
1004TP	132
1004TR	120
1004TW	114
1006AR	134
1006BB	140
1006DL	105
1006J	160
1006TB	122
1006TP	128
1006TR	116
1006TW	111
1007AR	134
1007BB	140
1007DL	105
1007J	160
1007TB	122
1007TP	128
1007TR	116
1007TW	111
1008AR	134
1008BB	140
1008DL	105
1008J	160
1008TB	122
1008TP	128
1008TR	116
1008TW	111
1009AR	134
1009BB	140
1009DL	105
1009J	160
1009TB	122
1009TP	128
1009TR	116
1009TW	111
1010AR	134
1010BB	140
1010DL	105
1010J	160
1010TB	122
1010TP	128
1010TR	116
1010TW	111
1012AR	134
1012BB	140
1012DL	105
1012J	160

Item #	Page #
1012TB	122
1012TP	128
1012TR	116
1012TW	111
1013AR	134
1013DL	105
1013TB	122
1013TP	128
1013TR	116
1013TW	111
1014AR	134
1014BB	140
1014DL	105
1014J	160
1014TB	122
1014TP	128
1014TR	116
1014TW	111
1015AR	134
1015DL	105
1015TB	122
1015TP	128
1015TR	116
1015TW	111
1016AR	134
1016DL	105
1016TB	122
1016TP	128
1016TR	116
1016TW	111
102.8AR	138
102.8BB	145
102.8DL	109
102.8J	165
102.8TB	126
102.8TP	132
102.8TR	120
102.8TW	114
1035BB	144
1035J	165
1036BB	144
1036J	165
1101AR	138
1101DL	109
1101JBR	158
1101TB	126
1101TP	132
1101TR	120
1101TW	114
1102AR	138
1102DL	109
1102TB	126

INDEX BY ITEM NUMBER

1
to
2

Item #	Page #
1102TP	132
1102TR	120
1102TW	114
1106AR	134
1106DL	105
1106TB	122
1106TP	128
1106TR	116
1106TW	111
1107AR	134
1107DL	105
1107TB	122
1107TP	128
1107TR	116
1107TW	111
1108AR	134
1108DL	105
1108TB	122
1108TP	128
1108TR	116
1108TW	111
1109AR	134
1109DL	105
1109TB	122
1109TP	128
1109TR	116
1109TW	111
1110AR	134
1110DL	105
1110TB	122
1110TP	128
1110TR	116
1110TW	111
1200CFB	196
1200CFG	196
1200CFR	196
1201BB	142
1201J	161
1202BB	142
1202J	161
1203BB	141
1203J	162
1206BB	140
1206J	160
1207BB	140
1207J	160
1208BB	140
1208J	160
1209BB	140
1209J	160
1210BB	140
1210J	160
1304BB	140
1304J	161
1305BB	140
1305J	161
1306BB	140
1306J	161

Item #	Page #
1307BB	140
1307J	161
1308BB	140
1308J	161
1338BB	145
1338J	165
1350BB	141
1350J	160
1360BB	141
1360J	160
1365BB	141
1365J	160
1400CFB	196
1400CFG	196
1400CFR	196
1501BB	141
1501J	161
1502BB	141
1502J	161
1503BB	141
1503J	162
1504BB	141
1504J	161
1505BB	141
1505J	161
1535BB	141
1535J	161
1600CFB	196
1600CFG	196
1600CFR	196
1607BB	142
1607J	162
1608BB	142
1608J	162
1609BB	142
1609J	162
1703TM	156
1704SS	11
1704TM	156
1704VT	14
1707SS	11
1707TM	153
1707VT	14
1708SS	11
1708TM	153
1708VT	14
1710SS	11
1710TM	153
1710VT	14
1712SS	11
1712TM	153
1712VT	14
1806SS	12
1806TM	153
1806VT	15
1807SS	12
1807TM	153
1807VT	15

Item #	Page #
1808SS	12
1808TM	153
1808VT	15
1809SS	12
1809TM	153
1809VT	15
1810SS	12
1810TM	153
1810VT	15
1812SS	12
1812TM	153
1812VT	15
1814SS	12
1814TM	153
1814VT	15
1816SS	12
1816TM	153
1816VT	15
19001BK	25
19001WT	33
19001SB	18
19001SG	21
19002BK	25
19002SB	18
19002SG	21
19002WT	33
1901GD	151
1901TM	156
1902TM	156
19035BK	25
19035WT	33
1903GD	150
1903TM	156
19045BK	25
19045WT	33
1904GD	150
1904TM	156
19055BK	25
19055WT	33
2008AR	135
2008BB	141
2008DL	106
2008J	161
2008TB	123
2008TP	129
2008TR	117
2008TW	112
2009AR	135
2009BB	141
2009DL	106
2009J	161
2009TB	123
2009TP	129
2009TR	117
2009TW	112
2010AR	135
2010BB	141
2010DL	106

Item #	Page #
2010J	161
2010TB	123
2010TP	129
2010TR	117
2010TW	112
2012AR	135
2012BB	141
2012DL	106
2012J	161
2012TB	123
2012TP	129
2012TR	117
2012TW	112
2014AR	135
2014DL	106
2014TB	123
2014TP	129
2014TR	117
2014TW	112
2016AR	135
2016DL	106
2016TB	123
2016TP	129
2016TR	117
2016TW	112
2109AR	135
2109DL	106
2109TB	123
2109TP	129
2109TR	117
2109TW	112
2110AR	135
2110DL	106
2110TB	123
2110TP	129
2110TR	117
2110TW	112
2112AR	135
2112DL	106
2112TB	123
2112TP	129
2112TR	117
2112TW	112
2113AR	135
2113DL	106
2113TB	123
2113TP	129
2113TR	117
2113TW	112
2114AR	135
2114DL	106
2114TB	123
2114TP	129
2114TR	117
2114TW	112
2308BB	142
2309BB	142
2311BB	142

INDEX BY ITEM NUMBER

Item #	Page #
24006BK	23
24006PR	27
24006SB	18
24006SG	21
24006WT	31
24007BK	23
24007PR	27
24007SB	18
24007SG	21
24007WT	31
24010BK	23
24010PR	27
24010SB	18
24010SG	21
24010WT	31
24012BK	23
24012PR	27
24012SB	18
24012SG	21
24012WT	31
2404SS	11
2404TM	156
2404VT	14
2406SS	11
2406TM	154
2406VT	14
2408SS	11
2408TM	154
2408VT	14
24110BK	25
24110PR	28
24110WT	33
2411TM	154
24120BK	23
24120PR	27
24120WT	31
2412TM	154
24140BK	23
24140PR	27
24140WT	31
2414TM	154
2416TM	154
29004BK	23
29004PR	27
29004SB	17
29004SG	20
29004WT	31
29006BK	23
29006SB	17
29006SG	20
29006PR	27
29006WT	31
29007BK	23
29007PR	27
29007SB	17
29007SG	20
29007WT	31
29009BK	23

Item #	Page #
29009PR	27
29009SB	17
29009SG	20
29009WT	31
29010BK	23
29010PR	27
29010SB	17
29010SG	20
29010WT	31
29012BK	23
29012PR	27
29012SB	17
29012SG	20
29012WT	31
29110BK	25
29110PR	28
29110WT	33
29115BK	25
29115PR	28
29115WT	33
3001BB	144
3001J	165
3004AR	138
3004DL	109
3004TB	126
3004TP	132
3004TR	120
3004TW	114
3005BB	144
3005J	165
3006AR	138
3006BB	144
3006DL	109
3006J	165
3006TB	126
3006TP	132
3006TR	120
3006TW	114
3008AR	138
3008BB	144
3008DL	109
3008J	165
3008TB	126
3008TP	132
3008TR	120
3008TW	114
30-27	190
30-28	190
30-55	190
3201AR	137
3201BB	145
3201CAR	137
3201CBB	145
3201CDL	108
3201CJ	164
3201CTB	125
3201CTP	131
3201CTR	119

Item #	Page #
3201DL	108
3201J	164
3201TB	125
3201TP	131
3201TR	119
3221JBR	158
3222JBR	158
3223JBR	158
3501BB	145
3501J	165
3502BB	145
3502J	164
3503BB	145
3503J	164
3504BB	145
3504J	164
3506BB	145
3506J	164
3540BB	144
3540J	164
3545BB	145
3545J	165
3601TM	156
3703TM	155
3704TM	155
3705TM	155
3706TM	155
3707TM	149
3708GD	149
3708TM	155
39045BK	24
39045PR	29
39045WT	32
39050BK	24
39050PR	29
39050WT	32
39055BK	24
39055PR	29
39055WT	32
39093BK	24
39093PR	29
39093SB	18
39093SG	21
39093WT	32
3955GD	151
3955TM	156
45-1	190
45-2	190
45-3	190
45-35	190
45-4	190
45-5	190
45-8	190
47128BK	25
47128PR	28
47128SB	17
47128SG	20
47128WT	33

Item #	Page #
49095BK	25
49095PR	28
49095SB	17
49095SG	20
49095WT	33
49136BK	25
49136PR	28
49136SB	17
49136SG	20
49136WT	33
49168BK	25
49168PR	28
49168SB	17
49168SG	20
49168WT	33
49208BK	25
49208PR	28
49208SB	17
49208SG	20
49208WT	33
5008BB	144
5008J	164
5008TB	125
5008TR	120
5060AR	136
5060BB	143
5060DL	107
5060J	163
5060TB	124
5060TP	130
5060TR	118
5065AR	136
5065BB	143
5065DL	107
5065J	163
5065TB	124
5065TP	130
5065TR	118
5070AR	136
5070BB	143
5070DL	107
5070J	163
5070TB	124
5070TP	130
5070TR	118
5075AR	136
5075BB	143
5075DL	107
5075J	163
5075TB	124
5075TP	130
5075TR	118
5085AR	136
5085BB	143
5085DL	107
5085J	163
5085TB	124
5085TP	130

INDEX BY ITEM NUMBER

5
to
7

Item #	Page #
5085TR	118
5095AR	136
5095BB	143
5095DL	107
5095J	163
5095TB	124
5095TP	130
5095TR	118
5106AR	137
5106BB	144
5106DL	108
5106J	164
5106TB	125
5106TP	131
5106TR	119
5106TW	113
5107AR	137
5107BB	144
5107DL	108
5107J	164
5107TB	125
5107TP	131
5107TR	119
5107TW	113
5108AR	137
5108BB	144
5108DL	108
5108J	164
5108TB	125
5108TP	131
5108TR	119
5108TW	113
5185JBR	158
5206AR	136
5206BB	144
5206DL	107
5206J	163
5206TB	124
5206TP	130
5206TR	118
5206TW	113
5207AR	136
5207BB	144
5207DL	107
5207J	163
5207TB	124
5207TP	130
5207TR	118
5207TW	113
5208AR	136
5208BB	144
5208DL	107
5208J	163
5208TB	124
5208TP	130
5208TR	118
5208TW	113
5265AR	137

Item #	Page #
5265BB	143
5265DL	107
5265J	164
5265TB	124
5265TP	130
5265TR	118
5265TW	113
5275AR	137
5275BB	143
5275DL	107
5275J	164
5275TB	124
5275TP	130
5275TR	118
5275TW	113
5285AR	137
5285BB	143
5285DL	107
5285J	164
5285TB	124
5285TP	130
5285TR	118
5285TW	113
5306AR	136
5306BB	143
5306DL	108
5306J	163
5306TB	125
5306TP	131
5306TR	119
5306TW	113
5307AR	136
5307BB	143
5307DL	108
5307J	163
5307TB	125
5307TP	131
5307TR	119
5307TW	113
5308AR	136
5308BB	143
5308DL	108
5308J	163
5308TB	125
5308TP	131
5308TR	119
5308TW	113
5309AR	136
5309BB	143
5309DL	108
5309J	163
5309TB	125
5309TP	131
5309TR	119
5309TW	113
5560JBR	158
5565JBR	158
5570JBR	158

Item #	Page #
5705SS	11
5705TM	155
5705VT	14
5706SS	11
5706TM	155
5706VT	14
5707SS	11
5707TM	155
5707VT	14
5765TM	155
5770SS	11
5770TM	155
5770VT	14
5780SS	11
5780TM	155
5780VT	14
62008BK	25
62008PR	29
62008SB	18
62008SG	21
62008WT	33
63010BK	25
63010PR	29
63010SB	18
63010SG	21
63010WT	33
6602GD	150
69003BK	24
69003PR	29
69003SB	18
69003SG	21
69003WT	32
69004BK	24
69004PR	29
69004SB	18
69004SG	21
69004WT	32
69005BK	24
69005PR	29
69005SB	18
69005SG	21
69005WT	32
69007BK	24
69007PR	29
69007SB	18
69007SG	21
69007WT	32
69008BK	24
69008PR	29
69008SB	18
69008SG	21
69008WT	32
69009BK	24
69009PR	29
69009SB	18
69009SG	21
69009WT	32
7000B	55

Item #	Page #
7000BL	88
7000G	43
7000R	51
7000V	47
7000W	63
7000Y	67
7001BB	146
7001BO	175
7001TL	174
7002BB	146
7002J	164
7002TP	132
7002TR	120
7003AR	138
7003B	126
7003BB	146
7003DL	109
7003GD	151
7003J	164
7003JBR	158
7003P	132
7003R	120
7003W	114
7004AR	138
7004TB	126
7004TP	132
7004TR	120
7005AR	138
7005B	126
7005BB	146
7005BO	175
7005DL	109
7005P	132
7005R	120
7005TL	174
7006BB	146
7006BO	175
7006TL	174
7007B	126
7007BB	146
7007BO	175
7007TL	174
7008BB	146
7008BO	175
7008TL	174
7009BB	146
7009BO	175
7009TL	174
7100J	164
7100JBR	158
7100TB	126
7100TR	120
7100TW	114
7200BK	25
7200JBR	158
7200PR	29
7200TW	114
7200WT	33

INDEX BY ITEM NUMBER

Item #	Page #
8004BB	146
8004J	165
8005BB	146
8005J	165
8006BB	146
8006J	165
8010AR	137
8010DL	108
8010TB	125
8010TP	131
8010TR	119
8011AR	137
8011DL	108
8011TB	125
8011TP	131
8011TR	119
9152AR	138
9152BB	145
9152DL	109
9152J	165
9152TB	126
9152TP	132
9152TR	120
9156TR	120
9302BB	145
9302J	165
9752TM	156
9753GD	151
9753TM	156
AD106AA	36
AD106WS	38
AD107AA	36
AD107WS	38
AD109AA	36
AD109WS	38
AD110AA	36
AD110WS	38
AD209AA	35
AD209WS	38
AD211AA	35
AD211WS	38
AD212AA	35
AD212WS	38
AD214AA	35
AD214WS	38
AD216AA	35
AD216WS	38
AD221AA	35
AD221WS	38
AD222AA	35
AD222WS	38
AD302AA	36
AD302WS	39
AD304WS	39
AD305AA	36
AD305WS	39
AD306AA	36
AD306WS	39

Item #	Page #
AD307AA	36
AD307WS	39
AD313WS	39
AD314WS	39
AD507AA	36
AD507WS	39
AD9016WS	39
AD908AA	36
AD908WS	39
AD918AA	36
AD918WS	39
ALBA0214	199
ALBA0312	199
ALBC007	296
ALBC008	296
ALBC009	296
ALBC010	296
ALBD006	296
ALBS001	179
ALBS002	179
ALBS003	179
ALBS004	179
ALBS005	179
ALBS006	179
ALBS007	179
ALCP0302	204
ALCP0303	204
ALCP0602	204
ALCP0603	204
ALCP0802	204
ALCP0803	204
ALCP0902	204
ALCP0903	204
ALCP1002	204
ALCP1003	204
ALCP1004	204
ALCP1202	204
ALCP1203	204
ALCP1204	204
ALCP1402	204
ALCP1403	204
ALCP1404	204
ALCP1602	204
ALCP1603	204
ALCP1604	204
ALDCS006	344
ALDN2036	284
ALDN2036E	284
ALDN2048	284
ALDN2048E	284
ALDN2060	284
ALDN2060E	284
ALDP048	203
ALDP048C	203
ALDP096	203
ALDP096C	203
ALDT045	340
ALDT060	340

Item #	Page #
ALES-005C	263
ALES005R	263
ALFN001	374
ALFP001	374
ALFP002	374
ALFPEX001C	328
ALFPEX002C	328
ALFPEX003C	328
ALFPEX004C	328
ALFPEX005C	328
ALHDCO001	310
ALHDCO002	310
ALHDCO003	310
ALHDCO101	310
ALHDCO102	310
ALHP004A	305
ALJM001	317
ALKAM005	205
ALKAM010	205
ALKAM020	205
ALKAM040	205
ALKMP012	199
ALKMP024	199
ALMC001	206
ALMH001	305
ALMH002	305
ALMT002	305
ALMTW001	305
ALPC001	184
ALPC002	184
ALPG008H	210
ALPMA005	203
ALPMA006	203
ALPMA007	203
ALPMA008	203
ALPMA009	203
ALPMA010	203
ALPMA012	203
ALPN009	203
ALPN010	203
ALPN011	203
ALPN012	203
ALPTCS008	209
ALPTCS009	209
ALPTCS010	209
ALPTCS011	209
ALPTCS012	209
ALPTCS013	209
ALPTCS014	209
ALPTCS015	209
ALPTCS016	209
ALPTCS017	209
ALPTCS018	209
ALPTWR008	209
ALPTWR009	209
ALPTWR010	209
ALPTWR011	209
ALPTWR012	209

Item #	Page #
ALPTWR013	209
ALPTWR014	209
ALPTWR015	209
ALPTWR016	209
ALPTWR017	209
ALPTWR018	209
ALPTWR019	209
ALPTWR020	209
ALPTWR022	209
ALPZ08	209
ALPZ09	209
ALPZ10	209
ALPZ11	209
ALPZ12	209
ALPZ13	209
ALPZ14	209
ALPZ15	209
ALPZ16	209
ALPZ17	209
ALPZ18	209
ALPZ19	209
ALPZ20	209
ALPZ22	209
ALRDH001	205
ALRDH002	205
ALRNP013	211
ALRNP015	211
ALRNP018	211
ALRP9603	325
ALRP9604	325
ALRP9605	325
ALSAP001	324
ALSAP002	324
ALSAP003	324
ALSAP004	324
ALSAP101	324
ALSAP102	324
ALSAP103	324
ALSAP104	324
ALSB001	179
ALSB002	179
ALSB003	179
ALSB004	179
ALSB005	179
ALSB006	179
ALSB007	179
ALSB008	179
ALSB009	179
ALSC1826	201
ALSF001	326
ALSF002	326
ALSF003	326
ALSH001	374
ALSH001EP	374
ALSKAC001	310
ALSKAC002	310
ALSKBK002	323
ALSKBK003	323

INDEX BY ITEM NUMBER

A
to
C

Item #	Page #
ALSKBK005	323
ALSKBK006	323
ALSKBK007	323
ALSKBK008	323
ALSKBK010	323
ALSKBK012	323
ALSKBP001	325
ALSKBP002	325
ALSKBP003	325
ALSKBP004	325
ALSKBP005	325
ALSKBP006	325
ALSKBP007	325
ALSKBP008	325
ALSKDB001	327
ALSKDB002	327
ALSKDB003	327
ALSKDB004	327
ALSKFP001C	328
ALSKFP002C	328
ALSKFP003C	328
ALSKFP004C	328
ALSKFP005C	328
ALSKFP101C	328
ALSKFP102C	328
ALSKFP103C	328
ALSKFP104C	328
ALSKFP105C	328
ALSKPC005	325
ALSKPC112	325
ALSKPC120	325
ALSKSP001	322
ALSKSP002	322
ALSKSP003	322
ALSKSP004	322
ALSKSP005	322
ALSKSP006	322
ALSKSP007	322
ALSKSP008	322
ALSKSP009	322
ALSKSP010	322
ALSKSP011	322
ALSKSP012	322
ALSKSP013	322
ALSKSP014	322
ALSKSP015	322
ALSKSP101	322
ALSKSP102	322
ALSKSP103	322
ALSKSP104	322
ALSKSP105	322
ALSKSP106	322
ALSKSP107	322
ALSKSP108	322
ALSKSP109	322
ALSKSP110	322
ALSKSP111	322
ALSKSP112	322

Item #	Page #
ALSKSP113	322
ALSKSP114	322
ALSKSP115	322
ALSKSP601	323
ALSKSP602	323
ALSKSP603	323
ALSKSP604	323
ALSKSP605	323
ALSKSP606	323
ALSKSP607	323
ALSKSP608	323
ALSKSP609	323
ALSKSP610	323
ALSKSP611	323
ALSKSS001	326
ALSKSS002	326
ALSKSS003	326
ALSKSS004	326
ALSKSS005	326
ALSKSS006	326
ALSKSS007	326
ALSKSS008	326
ALSKSS101	326
ALSKSS102	326
ALSKSS103	326
ALSKSS104	326
ALSKSS105	326
ALSKSS106	326
ALSKSS107	326
ALSKSS108	326
ALSKSU005	324
ALSKSU008	324
ALSKSU014	324
ALSKSU020	324
ALSKSU026	324
ALSKSU036	324
ALSKSU040	324
ALSKSU060	324
ALSKSU105	324
ALSKSU108	324
ALSKSU114	324
ALSKSU120	324
ALSKSU126	324
ALSKSU136	324
ALSKSU140	324
ALSKSU160	324
ALSKTP012	327
ALSP002	186
ALSP003	186
ALSP004	186
ALSP1006	200
ALSP1013	200
ALSP1622	200
ALSP1813	200
ALSP1813D	200
ALSP1813PF	200
ALSP1813PG	200
ALSP1826	200

Item #	Page #
ALSP1826D	200
ALSP1826H	200
ALSP1826HPF	200
ALSP1826M	200
ALSP1826PF	200
ALSP1826PG	200
ALSP1826S	200
ALSPR010	202
ALSPR020	202
ALSR001	184
ALSS010AC	327
ALSS030AC	327
ALSS050AC	327
ALST001	187
ALST002	187
ALST003	187
ALST004	187
ALST005	187
ALST006	187
ALST007	187
ALST008	187
ALST010	187
ALST011	187
ALST012	187
ALST013	187
ALST014	187
ALST015	187
ALST016	187
ALTBRCR001G	344
ALTBRCR111A	344
ALTWFC004	293
ALTWFC007	293
ALTWFC016	293
ALTWSC005	293
ALTWSC012	293
ALTWSC024	293
ALTWSC038	293
ALTWSC058	293
ALTWSC085	293
ALWDPP2512	210
ALWDPP3012	210
ALWDPP3512	210
ALWDPP5212	210
ALWP001	246
APLG022	342
APLG022D	342
APLG025	342
APLG025D	342
APPG022	342
APPG022D	342
APPG025	342
APPG025D	342
ASCS019BT	343
ASCS112	343
ASCS115	343
ASCS119	343
ASGD057	343
ASLG322	342

Item #	Page #
ASLG325	342
ASLG330	342
ASLS325	342
ASLS330	342
ASPG319	342
ASPG322	342
ASPG325	342
ASPG330	342
ASPS325	342
ASPS330	342
BACS002	197
BANP001	178
BANP002	178
BASR095JP	197
BASR195JP	197
BAST006	179
BAST008	179
BAST010	179
BAST012	179
BATP001	193
CETW001	186
CETW002	186
CETW003	186
CETW004	186
CETW005	186
CLRC001	266
CMCH014	375
CMCH018	375
CMCH021	375
CMCH024	375
CMDC014	375
CMDC018	375
CMDC021	375
CMDC024	375
CMDE014	375
CMDE018	375
CMDE021	375
CMDE024	375
CMEC008	373
CMEC034	373
CMEC063	373
CMEC072	373
CMEC086	373
CMEP1424	373
CMEP1430	373
CMEP1436	373
CMEP1448	373
CMEP1460	373
CMEP1472	373
CMEP1824	373
CMEP1830	373
CMEP1836	373
CMEP1842	373
CMEP1848	373
CMEP1854	373
CMEP1860	373
CMEP1872	373
CMEP2124	373

INDEX BY ITEM NUMBER

Item #	Page #	Item #	Page #	Item #	Page #	Item #	Page #
CMEP2130	373	CR006GR	41	CR110RD	50	CR5077W	62
CMEP2136	373	CR006PR	57	CR110V	46	CR5077YW	66
CMEP2142	373	CR006RD	49	CR110W	62	CR5510BU	55
CMEP2148	373	CR006V	45	CR110YW	66	CR5510GR	43
CMEP2154	373	CR006W	61	CR209BU	53	CR5510PR	59
CMEP2160	373	CR006YW	65	CR209GR	41	CR5510RD	51
CMEP2172	373	CR007BU	53	CR209PR	57	CR5510V	47
CMEP2424	373	CR007GR	41	CR209RD	49	CR5510W	63
CMEP2430	373	CR007PR	57	CR209V	45	CR5510YW	67
CMEP2436	373	CR007RD	49	CR209W	61	CR5608BU	54
CMEP2442	373	CR007V	45	CR209YW	65	CR5608GR	42
CMEP2448	373	CR007W	61	CR212BU	53	CR5608PR	58
CMEP2454	373	CR007YW	65	CR212GR	41	CR5608RD	50
CMEP2460	373	CR009BU	53	CR212PR	57	CR5608V	46
CMEP2472	373	CR009GR	41	CR212RD	49	CR5608W	62
CMPC008	372	CR009PR	57	CR212V	45	CR5608YW	66
CMPC034	372	CR009RD	49	CR212W	61	CR5712BU	55
CMPC063	372	CR009V	45	CR212YW	65	CR5712GR	43
CMPC072	372	CR009W	61	CR213BU	53	CR5712PR	59
CMPC086	372	CR009YW	65	CR213GR	41	CR5712RD	51
CMSV1424	372	CR010BU	53	CR213PR	57	CR5712V	47
CMSV1430	372	CR010GR	41	CR213RD	49	CR5712W	63
CMSV1436	372	CR010PR	57	CR213V	45	CR5712YW	67
CMSV1448	372	CR010RD	49	CR213W	61	CR5716BU	54
CMSV1460	372	CR010V	45	CR213YW	65	CR5716GR	42
CMSV1472	372	CR010W	61	CR303BU	55	CR5716PR	58
CMSV1824	372	CR010YW	65	CR303GR	43	CR5716RD	50
CMSV1830	372	CR012BU	53	CR303PR	59	CR5716V	46
CMSV1836	372	CR012GR	41	CR303RD	51	CR5716W	62
CMSV1842	372	CR012PR	57	CR303V	47	CR5716YW	66
CMSV1848	372	CR012RD	49	CR303W	63	CR5804BU	55
CMSV1854	372	CR012V	45	CR303YW	67	CR5804GR	43
CMSV1860	372	CR012W	61	CR305BU	55	CR5804PR	59
CMSV1872	372	CR012YW	65	CR305GR	43	CR5804RD	51
CMSV2124	372	CR106BU	54	CR305PR	59	CR5804V	47
CMSV2130	372	CR106GR	42	CR305RD	51	CR5804W	63
CMSV2136	372	CR106PR	58	CR305V	47	CR5804YW	67
CMSV2142	372	CR106RD	50	CR305W	63	CR5807BU	55
CMSV2148	372	CR106V	46	CR305YW	67	CR5807GR	43
CMSV2154	372	CR106W	62	CR313BU	55	CR5807PR	59
CMSV2160	372	CR106YW	66	CR313GR	43	CR5807RD	51
CMSV2172	372	CR107BU	54	CR313PR	59	CR5807V	47
CMSV2424	372	CR107GR	42	CR313RD	51	CR5807W	63
CMSV2430	372	CR107PR	58	CR313V	47	CR5807YW	67
CMSV2436	372	CR107RD	50	CR313W	63	CR5809BU	54
CMSV2442	372	CR107V	46	CR313YW	67	CR5809GR	42
CMSV2448	372	CR107W	62	CR5044BU	55	CR5809PR	58
CMSV2454	372	CR107YW	66	CR5044GR	43	CR5809RD	50
CMSV2460	372	CR109BU	54	CR5044PR	59	CR5809V	46
CMSV2472	372	CR109GR	42	CR5044RD	51	CR5809W	62
CR005BU	53	CR109PR	58	CR5044V	47	CR5809YW	66
CR005GR	41	CR109RD	50	CR5044W	63	CR5810BU	54
CR005PR	57	CR109V	46	CR5044YW	67	CR5810GR	42
CR005RD	49	CR109W	62	CR5077BU	54	CR5810PR	58
CR005V	45	CR109YW	66	CR5077GR	42	CR5810R	50
CR005W	61	CR110BU	54	CR5077PR	58	CR5810V	46
CR005YW	65	CR110GR	42	CR5077RD	50	CR5810W	62
CR006BU	53	CR110PR	58	CR5077V	46	CR5810YW	66

C

INDEX BY ITEM NUMBER

C
to
J

Item #	Page #
CR5811BU	54
CR5811GR	42
CR5811PR	58
CR5811RD	50
CR5811V	46
CR5811W	62
CR5811YW	66
CR710BU	53
CR710GR	41
CR710PR	57
CR710RD	49
CR710V	45
CR710W	61
CR710YW	65
CR804BK	24
CR804PR	58
CR804W	32
CR804YW	66
CR805BK	24
CR805PR	58
CR805W	32
CR805YW	66
CR806BK	24
CR806PR	58
CR806W	32
CR806YW	66
CR807BK	24
CR807PR	58
CR807W	32
CR807YW	66
CR9010BU	55
CR9010GR	43
CR9010PR	59
CR9010RD	51
CR9010V	47
CR9010W	63
CR9010YW	67
CR9016BU	55
CR9016GR	43
CR9016PR	59
CR9016RD	51
CR9016V	47
CR9016W	63
CR9016YW	67
CR9018BU	55
CR9018GR	43
CR9018PR	59
CR9018RD	51
CR9018V	47
CR9018W	63
CR9018YW	67
CR9303BU	55
CR9303GR	43
CR9303PR	59
CR9303RD	51
CR9303V	47
CR9303W	63
CR9303YW	67
CRCCT038	211
CRDB1218	264
CRDB1626	264
CRHH876	264
CRPT1015	262
CRPTS997	337
CRSP435	332
CRSP956	332
CRTCH008	332
CRTCH012	332
CRTCH014	332
CRTCH018	332
CRTSCD3812	278
DM005H	77
DM005J	82
DM006H	77
DM006J	82
DM007H	77
DM007J	82
DM009H	77
DM009J	82
DM010H	77
DM010J	82
DM012H	77
DM012J	82
DM209H	77
DM209J	82
DM212H	77
DM212J	82
DM213H	77
DM213J	82
DM5044H	77
DM5044J	82
DM5608H	77
DM5608J	82
DM5807H	77
DM5807J	82
DM5811H	77
DM5811J	82
GLCJ007	332
GLTWCC005	330
GLTWCC205	330
GLTWCS006	330
GLTWCS006P	330

Item #	Page #
CR9108BU	55
CR9108GR	43
CR9108PR	59
CR9108RD	51
CR9108V	47
CR9108W	63
CR9108YW	67
CR9303BU	55
CR9303GR	43
CR9303PR	59
CR9303RD	51
CR9303V	47
CR9303W	63
CR9303YW	67
CRCCT038	211
CRDB1218	264
CRDB1626	264
CRHH876	264
CRPT1015	262
CRPTS997	337
CRSP435	332
CRSP956	332
CRTCH008	332
CRTCH012	332
CRTCH014	332
CRTCH018	332
CRTSCD3812	278
DM005H	77
DM005J	82
DM006H	77
DM006J	82
DM007H	77
DM007J	82
DM009H	77
DM009J	82
DM010H	77
DM010J	82
DM012H	77
DM012J	82
DM209H	77
DM209J	82
DM212H	77
DM212J	82
DM213H	77
DM213J	82
DM5044H	77
DM5044J	82
DM5608H	77
DM5608J	82
DM5807H	77
DM5807J	82
DM5811H	77
DM5811J	82
GLCJ007	332
GLTWCC005	330
GLTWCC205	330
GLTWCS006	330
GLTWCS006P	330

Item #	Page #
GLTWOC006	331
GLTWOC206	331
GLTWPS001	330
GLTWPS002	330
GLTWSJ012	331
GLTWSJ012H	331
GLTWSJ012P	331
GLTWSS002	330
GLTWSS003	330
GLTWSY006	331
GLTWSY014	331
GLTWT001	330
GLTWT0201	330
GN001	263
GN1001W	177
GN1002W	177
GN1004W	177
GN1121W	177
GN1122W	177
GN1124W	177
GN1132W	177
GN1134W	177
GN1142W	177
GN1144W	177
GN1162W	177
GN1164W	177
GN1221W	177
GN1222W	177
GN1232W	177
GSR005L	272
GSR005N	272
H-205	189
HL-22	196
HL-23	196
HL36-2	196
HPCS008	180
IRBB001	354
IRBB002	354
IRBN001L	188
IRBN001N	188
IRBN002L	188
IRBN002N	188
IRBN003N	188
IRBR001L	188
IRBR001N	188
IRBR002CL	188
IRBR002CN	188
IRBR002L	188
IRBR002N	188
IRBR003CL	188
IRBR003CN	188
IRBR003L	188
IRBR003N	188
IRBR004CL	188
IRBR004CN	188
IRBR004L	188
IRBR004N	188
IRCP008	222

Item #	Page #
IRFFC001	290
IRFFC001B	290
IRFFC001W	290
IRFFC002	290
IRFFC002B	290
IRFFC002W	290
IRFFC003	290
IRFFC003B	290
IRFFC003W	290
IRFFC004	290
IRFFC004B	290
IRFFC004W	290
IRFFC005	290
IRFFC005B	290
IRFFC005W	290
IRFFC009H	290
IRFFC104	290
IRFS001	189
IRFS002	189
IRFS003	189
IRFS004	189
IRJM001	317
IRJWC001	185
IRJWC002	185
IRJWC301	185
IRJWC302	185
IRPA001	192
IRPA002	192
IRPA003	192
IRPA004	192
IRPC008	222
IRSCO01	244
IRSH4403	221
IRSK795	353
IRSP1107	354
IRSP1108	354
IRTC014	316
IRTISH100	272
IRTISH200	272
IRTISH300	272
IRTISH400	272
IRTP001	186
IRTP002	186
IRWC001	184
IRWC002	184
IRWC003	184
IRWC004	184
IRWC005	184
IRWC006	185
IRWC007	185
IRWK001	185
IRWK002	185
JAS010055A	182
JAS010055B	182
JAS012180	181
JAS012210	181
JAS012240	181
JAS012270	181

INDEX BY ITEM NUMBER

J
to
P

Item #	Page #
JAS012300	181
JAS012330	181
JAS013001	181
JAS013002	181
JAS013003	181
JAS013090	181
JAS014210	181
JAS014240	181
JAS014270	181
JAS014300	181
JAS022006	244
JPRB001	191
JPRB002	191
K109	193
ML350B1	170
ML351B1	170
ML351BL1	172
ML351C1	171
ML351CB1	171
ML351W1	170
ML352B1	170
ML352BL1	172
ML352C1	171
ML352CB1	171
ML352W1	170
ML507B1	170
ML507B1R	173
ML507BL1	172
ML507C1	171
ML507CB1	171
ML507W1	170
ML507W1R	173
ML509B1	170
ML509B1R	173
ML509BL1	172
ML509C1	171
ML509CB1	171
ML509W1	170
ML509W1R	173
ML531B1	170
ML531B1R	173
ML531BL1	172
ML531C1	171
ML531CB1	171
ML531W1	170
ML531W1R	173
ML532B1	170
ML532B1R	173
ML532BL1	172
ML532C1	171
ML532CB1	171
ML532W1	170
ML532W1R	173
ML533B1	170
ML533BL1	172
ML533C1	171
ML533CB1	171
ML533W1	170

Item #	Page #
ML534B1	170
ML534BL1	172
ML534C1	171
ML534CB1	171
ML534W1	170
ML535B1	170
ML535B1R	173
ML535BL1	172
ML535C1	171
ML535CB1	171
ML535W1	170
ML535W1R	173
ML536B1	170
ML536B1R	173
ML536BL1	172
ML536BU1	55
ML536C1	171
ML536CB1	171
ML536GR1	43
ML536PR1	59
ML536RD1	51
ML536W1	170
ML536W1R	173
ML536YW1	67
ML537B1	170
ML537B1R	173
ML537BL1	172
ML537C1	171
ML537CB1	171
ML537W1	170
ML537W1R	173
ML538B1	170
ML538B1R	173
ML538BL1	172
ML538BU1	55
ML538C1	171
ML538CB1	171
ML538GR1	43
ML538PR1	59
ML538RD1	51
ML538W1	170
ML538W1R	173
ML538YW1	67
ML539B1	170
ML539BL1	172
ML539C1	171
ML539CB1	171
ML539W1	170
ML801S	346
ML802S	346
ML803T	346
ML803W	346
ML9011I	47
ML9011PR	59
ML9011T	71
ML9011W	63
ML901I	47
ML901S	71

Item #	Page #
ML901T	71
ML901W	75
MLCS001	197
MLCS001B	197
MLCS001G	197
MLCS002	197
MRGR001	178
MRGR002	178
MRGR003	178
MRWC001R	220
MRWC002R	220
N-901PR	59
NS105T	69
NS105W	73
NS106T	69
NS106W	73
NS107T	69
NS107W	73
NS108T	69
NS108W	73
NS109T	69
NS109W	73
NS110T	69
NS110W	73
NS209T	70
NS209W	74
NS211T	70
NS211W	74
NS212T	70
NS212W	74
NS215T	70
NS215W	74
NS302T	71
NS302W	75
NS303T	71
NS303W	75
NS304T	71
NS304W	75
NS305T	71
NS305W	75
NS306T	71
NS306W	75
NS307T	71
NS307W	75
NS314T	71
NS314W	75
NS315T	71
NS315W	75
NS502T	71
NS502W	75
NS503T	71
NS503W	75
NS5060T	71
NS5060W	75
NS5065T	71
NS5065W	75
NS5070T	71
NS5070W	75

Item #	Page #
NS5075T	71
NS5075W	75
NS5085T	71
NS5085W	75
NS5095T	71
NS5095W	75
NS510T	70
NS510W	74
NS512T	70
NS512W	74
NS513T	70
NS513W	74
NS515T	70
NS515W	74
NS516T	70
NS516W	74
NS608-1R	69
NS608-1T	69
NS608-1W	73
NS608CR	69
NS608CT	69
NS608CW	73
NS608R	69
NS608T	69
NS608W	73
NS701T	69
NS701W	73
NS702T	69
NS702W	73
NS703T	69
NS703W	73
OW110	219
OW115	219
OW189	183
OW356	206
OW358	292
OW360	244
OW362	312
OW364	308
P-222	195
PATSC050	278
PCPC-1BL	335
PCPC-1BR	335
PH5005TW	195
PH5005V	195
PH5007TW	195
PH5007V	195
PH5008TW	195
PH5008V	195
PH5010TW	195
PH5010V	195
PL351BL1	172
PL352BL1	172
PL507BL1	172
PL509BL1	172
PL531BL1	172
PL532BL1	172
PL533BL1	172

INDEX BY ITEM NUMBER

P

Item #	Page #
PL534BL1	172
PL535BL1	172
PL536BL1	172
PL537BL1	172
PL538BL1	172
PL539BL1	172
PLA013	191
PLA016	191
PLBB008C	315
PLBB008M	315
PLBB010C	315
PLBB010M	315
PLBB012C	315
PLBB012M	315
PLBB1107	348
PLBB1209	348
PLBB825	348
PLBB825G	348
PLBB850	348
PLBB850G	348
PLBB900	348
PLBB900G	348
PLBC0012B	283
PLBC0013B	283
PLBC004P	220
PLBC006	222
PLBC3316B	283
PLBC3316G	283
PLBC4019B	283
PLBC4019G	283
PLBD006PP	258
PLBK008B	349
PLBK008G	349
PLBK008K	349
PLBK008R	349
PLBK008Y	349
PLBK1034B	349
PLBK1034G	349
PLBK1034K	349
PLBK1034R	349
PLBK1034Y	349
PLBK912G	349
PLBK938B	349
PLBK938G	349
PLBK938K	349
PLBK938R	349
PLBK938Y	349
PLBL240C	225
PLBL240G	225
PLBL240K	225
PLBL240R	225
PLBL240W	225
PLBM001S	207
PLBM002S	207
PLBM003S	207
PLBM004S	207
PLBM005S	207
PLBM006S	208

Item #	Page #
PLBM007S	208
PLBM008S	208
PLBM009S	208
PLBM010S	208
PLBM027BL	224
PLBM027R	224
PLBM0804S	208
PLBM1108S	208
PLBM1216S	208
PLBM1520S	208
PLBM1624S	208
PLBN1208T	348
PLBN1313T	348
PLBN1410T	348
PLBN1611T	348
PLBN1712T	348
PLBN1813T	348
PLBS010BG	300
PLBS010BK	300
PLBS010CL	300
PLBS010GR	300
PLBS010RD	300
PLBS010WH	300
PLBS110BG	300
PLBS110BK	300
PLBS110CL	300
PLBS110GR	300
PLBS110RD	300
PLBS110WH	300
PLBT002W	282
PLBT005B	282
PLBT005G	282
PLBT005W	282
PLBT007B	282
PLBT007G	282
PLBT007W	282
PLBT505BPF	282
PLBT505GPF	282
PLBT505WPF	282
PLBTC001B	282
PLBTC001G	282
PLBTC001W	282
PLBTC002W	282
PLCB001	260
PLCB002	260
PLCB003	260
PLCB004	260
PLCB005	260
PLCB006	260
PLCB007	260
PLCB008	260
PLCB011	260
PLCB012	260
PLCB013	260
PLCB014	260
PLCB015	260
PLCB016	260
PLCB017	260

Item #	Page #
PLCB181205BR	261
PLCB181205BU	261
PLCB181205GR	261
PLCB181205MX	261
PLCB181205PP	261
PLCB181205RD	261
PLCB181205WH	261
PLCB181205YW	261
PLCB201505BR	261
PLCB201505BU	261
PLCB201505GR	261
PLCB201505MX	261
PLCB201505PP	261
PLCB201505RD	261
PLCB201505WH	261
PLCB201505YW	261
PLCB241805BR	261
PLCB241805BU	261
PLCB241805GR	261
PLCB241805MX	261
PLCB241805PP	261
PLCB241805RD	261
PLCB241805WH	261
PLCB241805YW	261
PLCB3140	374
PLCB3140B	374
PLCB3150	259
PLCB3150B	259
PLCB4140	283
PLCB4140B	283
PLCB5140	374
PLCB5140B	374
PLCB5150	201
PLCBB02BR	262
PLCBB02BU	262
PLCBB02GR	262
PLCBB02RD	262
PLCBB02WH	262
PLCBB02YW	262
PLCBBR006	262
PLCD064	341
PLCD064D	341
PLCDB001	341
PLCH001-B	197
PLCH001-I	197
PLCJ007	332
PLCJ007C	332
PLCS001	197
PLCS002	197
PLCS003	197
PLDB003	284
PLDB004	284
PLDB005	284
PLDB006	284
PLDB007	284
PLDB182603PP	258
PLDB182606PP	258
PLDBC1826PP	258

Item #	Page #
PLDC001	345
PLDC002	345
PLDCT001	345
PLDLF001	374
PLDP002	279
PLDP003	279
PLDP345	279
PLDS005B	349
PLDS005C	349
PLDS005K	349
PLDS005P	349
PLFA006	258
PLFB001	311
PLFB002	311
PLFB003	311
PLFB004	311
PLFB005	311
PLFB121803PC	256
PLFB121803PP	257
PLFB121806PC	256
PLFB121806PP	257
PLFB121809PC	256
PLFB121809PP	257
PLFB182603PC	256
PLFB182603PP	257
PLFB182606PC	256
PLFB182606PP	257
PLFB182609PC	256
PLFB182609PP	257
PLFB182612PC	256
PLFB182612PP	257
PLFB182615PC	256
PLFB182615PP	257
PLFBC1218PC	256
PLFBC1218PP	257
PLFBC1826PC	256
PLFBC1826PP	257
PLFBD1218PC	256
PLFBD1218PP	257
PLFBD1826PC	256
PLFBD1826PP	257
PLFC001	241
PLFCCB001	284
PLFCCB001B	284
PLFCS330	280
PLFCS332	280
PLFDS285	283
PLFFT1014BK	345
PLFFT1014BR	345
PLFFT1014GR	345
PLFFT1014RD	345
PLFFT1014RR	345
PLFFT1216BK	345
PLFFT1216BR	345
PLFFT1216GR	345
PLFFT1216RD	345
PLFFT1216RR	345
PLFFT1418BK	345

INDEX BY ITEM NUMBER

P

Item #	Page #
PLFFT1418BR	345
PLFFT1418GR	345
PLFFT1418RD	345
PLFFT1418RR	345
PLFL330	280
PLFN004	245
PLFN005	245
PLFN006	245
PLFP001	311
PLFT1100BK	231
PLFT1100BR	231
PLFT1400BK	231
PLFT1400BR	231
PLFT1418BK	231
PLFT1418BR	231
PLFT1600BK	231
PLFT1600BR	231
PLFT2700BK	231
PLFT2700BR	231
PLFTD395	278
PLFTG006BG	301
PLFTG006BK	301
PLFTG006CL	301
PLFTG006GR	301
PLFTG006RD	301
PLFTG006WH	301
PLFTG009BG	301
PLFTG009BK	301
PLFTG009CL	301
PLFTG009GR	301
PLFTG009RD	301
PLFTG009WH	301
PLFTG012BG	301
PLFTG012BK	301
PLFTG012CL	301
PLFTG012GR	301
PLFTG012RD	301
PLFTG012WH	301
PLGL001	280
PLGL002	280
PLGL003	280
PLGL004	280
PLGL004BU	280
PLGL004GR	280
PLIB002S	259
PLIB005S	259
PLIB010S	259
PLIB021C	259
PLIB027C	259
PLIM1212SM	224
PLIS6901BK	368
PLIS6902BK	368
PLIS6903BL	368
PLIS6904RD	368
PLIS6905RD	368
PLIS6906RD	368
PLIS6907RD	368
PLIS6908BK	368

Item #	Page #
PLIS6909BL	368
PLIS6910RD	368
PLIS6911BL	368
PLIS6912BK	368
PLIS6913RD	368
PLIS6914BL	368
PLIS6951BK	369
PLIS6952BK	369
PLIS6953BK	369
PLIS6954BK	369
PLIS6955BK	369
PLIS6956BK	369
PLIS6957BL	369
PLIS6958BL	369
PLIS6959BL	369
PLIS6960BL	369
PLIS9301BK	370
PLIS9302BK	370
PLIS9303BK	370
PLIS9304BK	370
PLIS9305BK	370
PLIS9306BK	370
PLIS9307RD	370
PLIS9308BK	370
PLIS9309BK	370
PLIS9310BK	370
PLIS9311BK	370
PLIS9312BK	370
PLIS9313BK	370
PLIS9314BK	370
PLIS9315BK	370
PLIS9316RD	370
PLIS9317BK	370
PLIS9318BK	370
PLIS9319BK	370
PLIS9320BK	370
PLIS9321BK	371
PLIS9322BK	371
PLIS9323BK	371
PLIS9324BK	371
PLIS9325BK	371
PLIS9326BK	371
PLIS9327BK	371
PLIS9328BK	371
PLIS9329BK	371
PLIS9330BK	371
PLIS9331BK	371
PLIS9332BK	371
PLIS9333BK	371
PLIS9334BK	371
PLIS9335BK	371
PLIS9336BK	371
PLIS9337BK	371
PLIS9338BK	371
PLIS9339BK	371
PLIS9340BK	371
PLIS9341BK	371
PLIS9601BK	369

Item #	Page #
PLKB001	341
PLMC008CL	266
PLMC016CL	266
PLMC032CL	266
PLMC064CL	266
PLMC128CL	266
PLMD008CL	266
PLMD016CL	266
PLMD032CL	266
PLMD064CL	266
PLMD128CL	266
PLMENU-1BL	335
PLMENU-1BR	335
PLMENU-1GR	335
PLMENU-1MA	335
PLMENU-2BL	335
PLMENU-2BR	335
PLMENU-2GR	335
PLMENU-2MA	335
PLMENU-3BL	335
PLMENU-3BR	335
PLMENU-3GR	335
PLMENU-3MA	335
PLMENU-4	334
PLMENU-4BR	334
PLMENU-6BL	334
PLMENU-6BR	334
PLMENU-6GR	334
PLMENU-6MA	334
PLMENU-6TGI	334
PLMENU-L3BL	334
PLMENU-L3BR	334
PLMENU-L3GR	334
PLMENU-L3MA	334
PLMENU-L4BL	334
PLMENU-L4BR	334
PLMENU-L4GR	334
PLMENU-L4MA	334
PLMH001	333
PLMH002	333
PLMH003	333
PLMH004	333
PLMJ004BK	346
PLMJ010BK	346
PLMJ056BK	346
PLML008N	221
PLML008T	221
PLNB001	190
PLNB002	190
PLNP001	285
PLNP002	285
PLOP009BG	298
PLOP009BK	298
PLOP009CL	298
PLOP009GR	298
PLOP009RD	298
PLOP009WH	298
PLOP010BG	298

Item #	Page #
PLOP010BK	298
PLOP010CL	298
PLOP010GR	298
PLOP010RD	298
PLOP010WH	298
PLOP013BG	298
PLOP013BK	298
PLOP013CL	298
PLOP013GR	298
PLOP013RD	298
PLOP013WH	298
PLPA7000C	253
PLPA7000CBK	255
PLPA7000CS	253
PLPA7000CSBK	255
PLPA7000DS	253
PLPA7000DSBK	255
PLPA7120C	253
PLPA7120CBK	255
PLPA7120CS	253
PLPA7120CSBK	255
PLPA7120DS	253
PLPA7120DSBK	255
PLPA7120LC	253
PLPA7120LCBK	255
PLPA7120LDS	253
PLPA7120LDSBK	255
PLPA7130C	253
PLPA7130CBK	255
PLPA7130CS	253
PLPA7130CSBK	255
PLPA7130DS	253
PLPA7130DSBK	255
PLPA7140C	253
PLPA7140CBK	255
PLPA7140CS	253
PLPA7140CSBK	255
PLPA7140DS	253
PLPA7140DSBK	255
PLPA7160C	253
PLPA7160CBK	255
PLPA7160CS	253
PLPA7160CSBK	255
PLPA7160DS	253
PLPA7160DSBK	255
PLPA7190C	253
PLPA7190CBK	255
PLPA7190CS	253
PLPA7190CSBK	255
PLPA8002	252
PLPA8002BK	254
PLPA8004	252
PLPA8004BK	254
PLPA8006	252
PLPA8006BK	254
PLPA8008	252
PLPA8008BK	254
PLPA8122	252

INDEX BY ITEM NUMBER

P

Item #	Page #
PLPA8122BK	254
PLPA8122L	252
PLPA8122LBK	254
PLPA8124	252
PLPA8124BK	254
PLPA8124L	252
PLPA8124LBK	254
PLPA8126	252
PLPA8126BK	254
PLPA8128	252
PLPA8128BK	254
PLPA8132	252
PLPA8132BK	254
PLPA8134	252
PLPA8134BK	254
PLPA8136	252
PLPA8136BK	254
PLPA8138	252
PLPA8138BK	254
PLPA8142	252
PLPA8142BK	254
PLPA8144	254
PLPA8144BK	254
PLPA8146	252
PLPA8146BK	254
PLPA8162	252
PLPA8162BK	254
PLPA8164	252
PLPA8164BK	254
PLPA8166	252
PLPA8166BK	254
PLPA8192	252
PLPA8192BK	254
PLPA8194	252
PLPA8194BK	254
PLPB018	210
PLPB020	210
PLPB024	210
PLPCM001	213
PLPCTB108BL	351
PLPCTB108CL	351
PLPCTB108GR	351
PLPCTB108RD	351
PLPCTB110BL	351
PLPCTB110CL	351
PLPCTB110GR	351
PLPCTB110RD	351
PLPCTB112BL	351
PLPCTB112CL	351
PLPCTB112GR	351
PLPCTB112RD	351
PLPCTB114BL	351
PLPCTB114CL	351
PLPCTB114GR	351
PLPCTB114RD	351
PLPCTB116BL	351
PLPCTB116CL	351
PLPCTB116GR	351

Item #	Page #
PLPCTB116RD	351
PLPCTB120BL	351
PLPCTB120CL	351
PLPCTB120GR	351
PLPCTB120RD	351
PLPCTB124BL	351
PLPCTB124CL	351
PLPCTB124GR	351
PLPCTB124RD	351
PLPCTB308BL	350
PLPCTB308CL	350
PLPCTB308GR	350
PLPCTB308RD	350
PLPCTB310BL	350
PLPCTB310CL	350
PLPCTB310GR	350
PLPCTB310RD	350
PLPCTB312BL	350
PLPCTB312CL	350
PLPCTB312GR	350
PLPCTB312RD	350
PLPCTB314BL	350
PLPCTB314CL	350
PLPCTB314GR	350
PLPCTB314RD	350
PLPCTB316BL	350
PLPCTB316CL	350
PLPCTB316GR	350
PLPCTB316RD	350
PLPCTB320BL	350
PLPCTB320CL	350
PLPCTB320GR	350
PLPCTB320RD	350
PLPCTB324BL	350
PLPCTB324CL	350
PLPCTB324GR	350
PLPCTB324RD	350
PLPP001BK	295
PLPP002BK	295
PLPP003BK	295
PLPP004BK	295
PLPP005BK	295
PLPP006BK	295
PLPP007BK	295
PLPP008BK	295
PLPP009BK	295
PLPP010BK	295
PLPP011BK	295
PLPP012BK	295
PLPR050C	228
PLPR050M	228
PLPR063C	228
PLPR063M	228
PLPR075C	228
PLPR075M	228
PLPR088C	228
PLPR088M	228
PLPR100C	228

Item #	Page #
PLPR100M	228
PLPR113C	228
PLPR113M	228
PLPR125C	228
PLPR125M	228
PLPR150C	228
PLPR150M	228
PLPR200C	228
PLPR200M	228
PLPR501S	227
PLPR502S	227
PLPR503S	227
PLPR504S	227
PLPR505S	227
PLPR506S	227
PLPR507S	227
PLPR600AM	229
PLPR600CL	229
PLPR600RD	229
PLPR600SM	229
PLPR700BK	229
PLPR700CL	229
PLPR700RD	229
PLPR800BK	229
PLPR800CL	229
PLPR800RD	229
PLPR900BK	229
PLPR900BL	229
PLPR900CL	229
PLPR900GR	229
PLPR900RD	229
PLPR900WH	229
PLPR900YW	229
PLPRC001	227
PLPRC002BK	227
PLPRC002RD	227
PLPRC020	202
PLPT046BL	336
PLPT046BR	336
PLPT016A	352
PLPT016C	352
PLPTD394	278
PLRC005	202
PLRC005B	202
PLRCB001	260
PLRCB002	260
PLRCF001H	237
PLRCF001R	237
PLRDH003	205
PLRFC0001PC	249
PLRFC0001PP	249
PLRFC0001TL	249
PLRFC0204PC	249
PLRFC0204PP	249
PLRFC0204TL	249
PLRFC0608PC	249
PLRFC0608PP	249
PLRFC0608TL	249

Item #	Page #
PLRFC121822PC	249
PLRFC121822PP	249
PLRFC121822TL	249
PLRFT301PC	248
PLRFT301PP	249
PLRFT301TL	248
PLRFT302PC	248
PLRFT302PP	249
PLRFT302TL	248
PLRFT304PC	248
PLRFT304PP	249
PLRFT304TL	248
PLRFT306PC	248
PLRFT306PP	249
PLRFT306TL	248
PLRFT308PC	248
PLRFT308PP	249
PLRFT308TL	248
PLRFT312PC	248
PLRFT312PP	249
PLRFT312TL	248
PLRFT318PC	248
PLRFT318PP	249
PLRFT318TL	248
PLRFT322PC	248
PLRFT322PP	249
PLRFT322TL	248
PLRM005W	337
PLRPD392	277
PLRPD396	277
PLRPSS	374
PLRS001	195
PLRS003	195
PLRSB064	285
PLRT012	230
PLRT012BCK	230
PLRT012CK	230
PLRT014	230
PLRT014BCK	230
PLRT014CK	230
PLRT016	230
PLRT016BCK	230
PLRT016CK	230
PLRT1612	230
PLRT1612BCK	230
PLRT1612CK	230
PLSB703	285
PLSC006CL	293
PLSC012CL	293
PLSC024CL	293
PLSC064CL	293
PLSD001	331
PLSD002	331
PLSD377	276
PLSFT002PC	250
PLSFT002PP	251
PLSFT002TL	250
PLSFT004PC	250

INDEX BY ITEM NUMBER

Item #	Page #
PLSFT004PP	251
PLSFT004TL	250
PLSFT006PC	250
PLSFT006PP	251
PLSFT006TL	250
PLSFT008PC	250
PLSFT008PP	251
PLSFT008TL	250
PLSFT012PC	250
PLSFT012PP	251
PLSFT012TL	250
PLSFT018PC	250
PLSFT018PP	251
PLSFT018TL	250
PLSFT0204C	251
PLSFT022PC	250
PLSFT022PP	251
PLSFT022TL	250
PLSFT0608C	251
PLSFT121822C	251
PLSGTG006BG	301
PLSGTG006BK	301
PLSGTG006CL	301
PLSGTG006GR	301
PLSGTG006RD	301
PLSGTG006WH	301
PLSGTG009BG	301
PLSGTG009BK	301
PLSGTG009CL	301
PLSGTG009GR	301
PLSGTG009RD	301
PLSGTG009WH	301
PLSGTG012BG	301
PLSGTG012BK	301
PLSGTG012CL	301
PLSGTG012GR	301
PLSGTG012RD	301
PLSGTG012WH	301
PLSL003BK	374
PLSL006BK	374
PLSL113BK	374
PLSL116BK	374
PLSNP01B	226
PLSNP01G	226
PLSNP01O	226
PLSNP01R	226
PLSNP01W	226
PLSNP01Y	226
PLSNP02B	226
PLSNP02G	226
PLSNP02O	226
PLSNP02R	226
PLSNP02W	226
PLSNP02Y	226
PLSP001	279
PLSP002	279
PLSP002D	337
PLSP010	308

Item #	Page #
PLSP010HR	308
PLSP010SHR	308
PLSP014	308
PLSP014HR	308
PLSP014SHR	308
PLSP016	308
PLSP016HR	308
PLSP016SHR	308
PLSP032BK	333
PLSP032CH	333
PLSP032CL	333
PLSP032WT	333
PLSP1013C	201
PLSP1813C	201
PLSP1826C	201
PLSPT0802	191
PLSPT0902	191
PLSPT1102	191
PLSS111BG	299
PLSS111BK	299
PLSS111CL	299
PLSS111GR	299
PLSS111RD	299
PLSS111WH	299
PLSS113BG	300
PLSS113BK	300
PLSS113CL	300
PLSS113GR	300
PLSS113RD	300
PLSS113WH	300
PLSS211BG	299
PLSS211BK	299
PLSS211CL	299
PLSS211GR	299
PLSS211RD	299
PLSS211WH	299
PLSS213BG	299
PLSS213BK	299
PLSS213CL	299
PLSS213GR	299
PLSS213RD	299
PLSS213WH	299
PLSSGR001	222
PLST1100BL	230
PLST1100BR	230
PLST1400BL	230
PLST1400BR	230
PLST1418BL	230
PLST1418BR	230
PLST1600BL	230
PLST1600BR	230
PLST2700BL	230
PLST2700BR	230
PLSTD393	278
PLSVM1218BL	224
PLSVM1218R	224
PLTC010W	281
PLTC010WL	281

Item #	Page #
PLTC020G	281
PLTC020GL	281
PLTC020W	281
PLTC020WL	281
PLTC023B	281
PLTC023BL	281
PLTC023G	281
PLTC023GL	281
PLTC023K	281
PLTC023KL	281
PLTC023R	281
PLTC023RC	281
PLTC023RL	281
PLTC023RP	281
PLTC032G	281
PLTC032GH	281
PLTC032GL	281
PLTC044G	281
PLTC044GH	281
PLTC044GL	281
PLTCD005	281
PLTCD023	281
PLTD003	331
PLTHBK040C	216
PLTHBK140C	216
PLTHCF050CC	218
PLTHCF075NC	218
PLTHCF100CC	218
PLTHCG008C	216
PLTHCF007C	217
PLTHEP016C	214
PLTHEP020C	214
PLTHFL005C	216
PLTHGL020C	217
PLTHHC016C	217
PLTHHC024C	217
PLTHMG016C	214
PLTHMG020C	214
PLTHMR009C	216
PLTHMR011C	216
PLTHMT008C	216
PLTHPS013C	213
PLTHPS023C	213
PLTHRG008C	215
PLTHRG010C	215
PLTHRG012C	215
PLTHRG208C	213
PLTHRG210C	213
PLTHRG212C	213
PLTHSB008C	344
PLTHSB008R	344
PLTHSB008Y	344
PLTHSB012C	344
PLTHSB012R	344
PLTHSB012Y	344
PLTHSB016CW	344
PLTHSB016RW	344
PLTHSB016YW	344

Item #	Page #
PLTHSB024C	344
PLTHSB024CW	344
PLTHSB024R	344
PLTHSB024RW	344
PLTHSB024Y	344
PLTHSB024YW	344
PLTHSB032CW	344
PLTHSB032RW	344
PLTHSB032YW	344
PLTHSG001CC	215
PLTHSG002AC	215
PLTHSG002CC	215
PLTHSG015CC	215
PLTHSG125SC	215
PLTHSG130SC	215
PLTHSL001W	218
PLTHSN024C	218
PLTHSS016C	218
PLTHST012C	215
PLTHST014C	215
PLTHST212C	213
PLTHST214C	213
PLTHTB005A	352
PLTHTB005B	352
PLTHTB005C	352
PLTHTB005R	352
PLTHTB008A	352
PLTHTB008B	352
PLTHTB008C	352
PLTHTB008R	352
PLTHTB010A	352
PLTHTB010B	352
PLTHTB010C	352
PLTHTB010R	352
PLTHTB012A	352
PLTHTB012B	352
PLTHTB012C	352
PLTHTB012R	352
PLTHTB016A	352
PLTHTB016B	352
PLTHTB016C	352
PLTHTB016R	352
PLTHTB020A	352
PLTHTB020B	352
PLTHTB020C	352
PLTHTB020R	352
PLTHTB024A	352
PLTHTB024B	352
PLTHTB024C	352
PLTHTB024R	352
PLTHTB032A	352
PLTHTB032B	352
PLTHTB032C	352
PLTHTB032R	352
PLTHTB032TA	352
PLTHTB032TB	352
PLTHTB032TC	352
PLTHTB032TR	352

INDEX BY ITEM NUMBER

Item #	Page #
PLTHWD009C	218
PLTHWG011RC	217
PLTHWG014RC	217
PLTHWG023RC	217
PLTHWG025RC	217
PLTHWP015C	214
PLTHWP020C	214
PLTN4025	332
PLTN4050	332
PLTN4100	332
PLTP050A	222
PLTP050S	222
PLTSCD3812	278
PLTW085BK	347
PLTW085BR	347
PLTWCS006	330
PLTWRH078C	328
PLTWRH112C	328
PLTWRH114C	328
PLVS001	244
PLVS002	244
PLVS003	244
PLWB001	311
PLWB002	311
PLWB003	311
PLWB004	311
PLWB005	311
PLWB361	280
PLWB361B	280
PLWB361W	280
PLWC001	196
PLWFC024	280
PLWFC027	280
PLWP032CL	214
PLWP064CL	214
PLWS020BK	343
PLWS020BKL	343
PLWS020WT	343
PLWS020WTL	343
PLWS042BK	343
PLWS042BKL	343
PLWS042WT	343
PLWS042WTL	343
PLWS064BK	343
PLWS064BKL	343
PLWS064WT	343
PLWS064WTL	343
PLWT007K	281
PLWT007R	281
PS1515RD	99
PS1515V	96
PS1515W	102
PS3008RD	99
PS3008V	96
PS3008W	102
PS3010RD	99
PS3010V	96
PS3010W	102

Item #	Page #
PS3014RD	99
PS3014V	96
PS3014W	102
PS3103RD	100
PS3103V	97
PS3103W	103
PS3105RD	100
PS3105V	97
PS3105W	103
PS3106RD	100
PS3106V	97
PS3106W	103
PS3110RD	100
PS3110V	97
PS3110W	103
PS3111RD	100
PS3111V	97
PS3111W	103
PS3204RD	100
PS3204V	97
PS3204W	102
PS3208RD	99
PS3208V	96
PS3208W	102
PS3211RD	99
PS3211V	96
PS3211W	102
PS3214RD	99
PS3214V	96
PS3214W	102
PS5004RD	100
PS5004V	97
PS5004W	103
PS5005RD	100
PS5005V	97
PS5005W	103
PS5006RD	100
PS5006V	97
PS5006W	103
PS5008RD	100
PS5008V	97
PS5008W	103
PS5010RD	100
PS5010V	97
PS5010W	103
PS5103RD	99
PS5103V	96
PS5103W	102
PS5104RD	99
PS5104V	96
PS5104W	102
PS6013RD	100
PS6013V	97
PS6013W	103
PS9475RD	100
PS9475V	97
PS9475W	103
RER55ASL	272

Item #	Page #
RER55ASN	272
RF1006BW	88
RF1006G	91
RF1010BW	88
RF1010G	91
RF1016B	87
RF1016BW	88
RF1016G	91
RF1016W	87
RF1018B	87
RF1018BW	88
RF1018G	91
RF1018W	87
RF1020B	87
RF1020BW	88
RF1020G	92
RF1020W	87
RF1065BW	88
RF1112B	88
RF2024B	87
RF2024BW	89
RF2024G	92
RF2024W	87
RF2030B	87
RF2030BW	89
RF2030G	92
RF2030W	87
RF2224BW	89
RF2920G	92
RF5065BW	89
RF5112BW	89
RF6016BW	88
RF7010B	89
RF7010W	89
RF9475BW	89
RYTP351A	280
SB514N	94
SB514S	94
SB514W	94
SB520N	94
SB520S	94
SB520W	94
SB608N	94
SB608S	94
SB608W	94
SB612N	94
SB612S	94
SB612W	94
SCSL001	266
SCSL002	266
SCSL003	266
SCSL004	266
SCSL005	266
SCSL006	266
SCSL007	266
SCSL008	266
SCSL103	266
SCSL104	266

Item #	Page #
SD2118H	79
SD2118J	84
SD2121H	79
SD2121J	84
SD3206H	80
SD3206J	85
SD3208H	80
SD3208J	85
SD3210H	80
SD3210J	85
SD3212H	80
SD3212J	85
SD3214H	80
SD3214J	85
SD3216H	80
SD3216J	85
SD3314H	80
SD3314J	85
SD3318H	80
SD3318J	85
SD3324H	80
SD3324J	85
SD5609H	79
SD5609J	84
SD5612H	79
SD5612J	84
SD5613H	79
SD5613J	84
SD5614H	79
SD5614J	84
SD6015H	79
SD6015J	84
SD6018H	79
SD6018J	84
SEJ001	274
SEJ002	274
SEJ003	274
SEJ004	274
SEJ004A	274
SEJ008	274
SEJ009	274
SEJ010	274
SEJ011	274
SEJ012	274
SEJ013	274
SEJ014	274
SEJ12007	270
SEJ12007-1	270
SEJ18000	274
SEJ20000	274
SEJ21000	274
SEJ22000	274
SEJ30000C	270
SEJ30000TW	270
SEJ31000C	270
SEJ31000TW	270
SEJ32000C	270
SEJ32000TW	270

INDEX BY ITEM NUMBER

Item #	Page #
SEJ3201	273
SEJ35000C	270
SEJ38000C	271
SEJ45000C	272
SEJ50000	273
SEJ50000T	273
SEJ60000	273
SEJ6012	273
SEJ64020	273
SEJ71000	189
SEJ72000	189
SEJ73000	189
SEJ74000	189
SEJ80000	271
SEJ80000C	271
SEJ81000C	271
SEJ90000	275
SEJ90001C	275
SEJ90001R	275
SEJ92000	275
SEJ92001C	275
SEJ92001R	275
SEJB001	273
SEJB001T	273
SEJB002	273
SLADD05	211
SLADD06	211
SLAL005	194
SLAL01A	194
SLAL01B	194
SLAL02A	194
SLAL02B	194
SLAL03A	194
SLAL03B	194
SLAL04A	194
SLAL04B	194
SLAM102	363
SLAM103	363
SLAM104	363
SLAM105	363
SLAM106	363
SLAM107	363
SLAM109	363
SLAT201	356
SLAT202	356
SLAT203	356
SLAT204	356
SLAT205	356
SLAT206	356
SLAT207	356
SLAT209	356
SLAT210	356
SLAT211	356
SLAT212	356
SLAT215	356
SLAT216	356
SLAT218	356
SLAT219	356

Item #	Page #
SLBELL001	336
SLBF001	239
SLBF002	239
SLBF003	239
SLBF004	239
SLBF005	239
SLBF006	239
SLBF007	239
SLBF008	239
SLBF009	239
SLBF010	239
SLBF011	239
SLBF012	239
SLBF013	239
SLBF014	239
SLBF015	239
SLBF101	238
SLBF102	238
SLBF103	238
SLBF105	238
SLBF106	238
SLBF109	238
SLBK013	353
SLBM001	247
SLBM002	247
SLBM003	247
SLBM004	247
SLBM005	247
SLBM006	247
SLBM007	247
SLBM008	247
SLBM009	247
SLBM010	247
SLBM011	247
SLBM012	247
SLBO002	219
SLBO003	219
SLBO004	219
SLBO005	219
SLBO106	219
SLBP0804W	305
SLBS022	221
SLBT075	303
SLBT095	303
SLBT115	303
SLBW004	338
SLCB008C	315
SLCB008F	315
SLCB010C	315
SLCB010F	315
SLCB012C	315
SLCB012F	315
SLCCA13	219
SLCF001	340
SLCF002	340
SLCF003	340
SLCH007	197
SLCIL11L	310

Item #	Page #
SLCIL11S	310
SLCIL13L	310
SLCIL13S	310
SLCIL15L	310
SLCIL15S	310
SLCJ007C	332
SLCJH002	332
SLCJH003	332
SLCJH004	332
SLCN001	181
SLCN004	220
SLCN005	220
SLCN006	220
SLCRT004	346
SLCS001	240
SLCS3172	341
SLCS3173	341
SLCS3174	341
SLCS3175	341
SLCS3176	341
SLCST006	346
SLCT010	240
SLCT012	240
SLCT014	240
SLCT016	240
SLCT018	240
SLCT310	240
SLCT312	240
SLCT314	240
SLCT316	240
SLCT318	240
SLDA008	289
SLDA010	289
SLDA012	289
SLDA016	289
SLDA020	289
SLDA024	289
SLDA030	289
SLDA040	289
SLDA050	289
SLDA060	289
SLDA070	289
SLDA100	289
SLDAOVAL	289
SLDB4008	320
SLDB4008C	320
SLDB4012	320
SLDB4012C	320
SLDB4016	320
SLDB4016C	320
SLDB4020	320
SLDB4020C	320
SLDK102	362
SLDK103	362
SLDK104	362
SLDK105	362
SLDK106	362
SLDK106F	362

Item #	Page #
SLDK107	362
SLDK108	362
SLDK109	362
SLDM201	357
SLDM202	357
SLDM203	357
SLDM204	357
SLDM205	357
SLDM206	357
SLDM207	357
SLDM208	357
SLDM209	357
SLDM210	357
SLDM211	357
SLDM212	357
SLDM215	357
SLDM218	357
SLDO001	366
SLDO002	366
SLDO003	366
SLDO004	366
SLDO005	366
SLDO006	366
SLDO007	366
SLDO008	366
SLDO009	366
SLDO011	366
SLDO102	366
SLDO103	366
SLDO104	366
SLDO105	366
SLDO106	366
SLDO107	366
SLDO109	366
SLDS006	287
SLDS006L	287
SLDS008	287
SLDS008L	287
SLDS010	287
SLDS010L	287
SLDS012	287
SLDS012L	287
SLDS016	287
SLDS016L	287
SLDS020	287
SLDS020L	287
SLDS024	287
SLDS024L	287
SLDS030	287
SLDS030L	287
SLDS040	287
SLDS040L	287
SLDS060P	308
SLDS206G	286
SLDS206P	286
SLDS208G	286
SLDS208P	286
SLDS210G	286

S

INDEX BY ITEM NUMBER

S

Item #	Page #
SLDS210P	286
SLDS212G	286
SLDS212P	286
SLDS216G	286
SLDS216P	286
SLDS220G	286
SLDS220P	286
SLDS224G	286
SLDS224P	286
SLDS230G	286
SLDS230P	286
SLDS240G	286
SLDS240P	286
SLDW0001	219
SLEC001	337
SLEC002	337
SLEL201	358
SLEL202	358
SLEL203	358
SLEL204	358
SLEL205	358
SLEL206	358
SLEL207	358
SLEL208	358
SLEL209	358
SLEL210	358
SLEL211	358
SLEL212	358
SLEL218	358
SLER0301R	302
SLER0401R	302
SLER0401S	302
SLER0501R	302
SLER0601R	302
SLES102	363
SLES103	363
SLES104	363
SLES105	363
SLES106	363
SLES107	363
SLES109	363
SLFB001	329
SLFB002	329
SLFB003	329
SLFB004	329
SLFB005	329
SLFB006	329
SLFB007	329
SLFB008	329
SLFB009	329
SLFBP010	329
SLFBP014	329
SLFC001	241
SLFC002	241
SLFC004	241
SLFC006	241
SLFC007	241
SLFC008	241

Item #	Page #
SLFCR005	339
SLFD001	194
SLFD002	194
SLFDS310	283
SLFDS385	283
SLFDS510	283
SLFFB001	291
SLFFB001L	291
SLFFB001R	291
SLFFC001	337
SLFFC003	337
SLFFC005	337
SLFM001	194
SLFN005	245
SLFN006	245
SLFS008	211
SLFT065P	306
SLFT065S	306
SLGB003	336
SLGB005	336
SLGB008	336
SLGB013	268
SLGB018	268
SLGB024	268
SLGB026	221
SLGD001	364
SLGD002	364
SLGD003	364
SLGD004	364
SLGD005	364
SLGD006	364
SLGD007	364
SLGD008	364
SLGD009	364
SLGD010	364
SLGD011	364
SLGF004	355
SLGL001	294
SLGR004	292
SLGR025	292
SLGT008	338
SLGT012	338
SLGT020	338
SLGT108	338
SLGT112	338
SLGT120	338
SLHF1620	279
SLHF1625	279
SLHF2016	279
SLHF2020	279
SLHF2025	279
SLHO030	222
SLHT064P	306
SLIC001	246
SLIC002	246
SLIG001	223
SLIG002	223
SLIG003	223

Item #	Page #
SLIG004	223
SLIG008	223
SLIL001	310
SLIL002	310
SLIL003	310
SLIL004	310
SLINS001	220
SLINS002	220
SLIP001	247
SLIP002	247
SLIP003	247
SLIP004	247
SLIP005	247
SLIP006	247
SLIP007	247
SLIP008	247
SLIT007	303
SLJG001	223
SLJG002	223
SLJG003	223
SLJS031	221
SLKB164	341
SLKB166	341
SLKBS011	221
SLKCC005	263
SLKCP008	312
SLKCP010	312
SLKCP012	312
SLKCP108	312
SLKCP110	312
SLKCP112	312
SLKCP208	312
SLKCP208R	312
SLKCP210	312
SLKCP210R	312
SLKF002	182
SLKF003HK	182
SLKF004HK	182
SLKF005HK	182
SLKF012	183
SLKF016	183
SLKF017	183
SLKF018	183
SLKF019	183
SLKF020	183
SLKF021	182
SLKF025	183
SLKGH010	225
SLKGH010C	225
SLKGH016	225
SLKGH016C	225
SLKGH024	225
SLKGH024C	225
SLKMP012	199
SLKMP024	199
SLKMP124	199
SLKR012	268
SLKSW008	305

Item #	Page #
SLKSW095	305
SLKSW108	305
SLKVP006	292
SLKVP006RD	292
SLKW048	312
SLLA001	295
SLLA002	295
SLLC006A	355
SLLC006B	355
SLLC116W	355
SLLD002	288
SLLD002A	288
SLLD003	288
SLLD003A	288
SLLD004	288
SLLD004A	288
SLLD006	288
SLLD006A	288
SLLD008	288
SLLD008A	288
SLLD102P	288
SLLD102PA	288
SLLD103P	288
SLLD103PA	288
SLLD104P	288
SLLD104PA	288
SLLD106P	288
SLLD106PA	288
SLLD108P	288
SLLD108PA	288
SLLD309	178
SLLD310	178
SLLD311	178
SLMB001	309
SLMB002	309
SLMB003	309
SLMB004	309
SLMB005	309
SLMB006	309
SLMB007	309
SLMB008	309
SLMB009	309
SLMB030	309
SLMB201	309
SLMB202	309
SLMB203	309
SLMB204	309
SLMB205	309
SLMB206	309
SLMB207	309
SLMB208	309
SLMB209	309
SLMBH003	276
SLMBH024	276
SLMBP075	310
SLMBP150	310
SLMBP200	310
SLMC001	223

INDEX BY ITEM NUMBER

S

Item #	Page #
SLMC2414	206
SLMC2415	206
SLMC2416	206
SLME012	339
SLME020	339
SLME033	339
SLME050	339
SLME066	339
SLME266	339
SLMH001	333
SLMH002	333
SLMH008	332
SLMH012	332
SLMH018	332
SLMLB002	244
SLMP0018	339
SLMP0024	339
SLMP0040	339
SLMP024	263
SLMP030	263
SLMP036	263
SLMP042	263
SLMP048	263
SLMP054	263
SLMP060	263
SLMS013V	206
SLMS025L	206
SLMS025V	206
SLMS033V	206
SLMS050L	206
SLMS050V	206
SLMS100L	206
SLMS100V	206
SLMS150L	206
SLMW040	312
SLNH001	331
SLNH002	331
SLNP001	364
SLNP002	364
SLNP003	364
SLNP004	364
SLNP005	364
SLNP006	364
SLNP007	364
SLNP008	364
SLNP009	364
SLNP010	364
SLNP011	364
SLNS001	180
SLNS002	180
SLNS005	180
SLNS536	180
SLNS553	180
SLOK008	307
SLOK010	307
SLOK012	307
SLOL001	294
SLOL002	294

Item #	Page #
SLOL003	294
SLOL004	294
SLOL005	294
SLOL006	294
SLOL007	294
SLOL007H	294
SLOL008	294
SLOL201	298
SLOL202	298
SLOL203	298
SLOL204	298
SLOL205	298
SLOL206	298
SLOL207	298
SLOL208	298
SLOP010	240
SLOP012	240
SLOP014	240
SLOP016	240
SLOP018	240
SLOP020	240
SLOP022	240
SLOP024	240
SLOP026	240
SLOS001	314
SLOS002	314
SLPAL002	247
SLPAL006	247
SLPAL009	247
SLPAL013	247
SLPAL016	247
SLPB030	221
SLPBA111	297
SLPBA112	297
SLPBA113	297
SLPBA211	297
SLPBA212	297
SLPBA213	297
SLPBA311	297
SLPBA312	297
SLPBA313	297
SLPC230	241
SLPC250	241
SLPG008D	210
SLPG008S	210
SLPH002	311
SLPH003	311
SLPH004	311
SLPH005	311
SLPH007	311
SLPHAP066	246
SLPHAP068	246
SLPHAP088	246
SLPMR018	292
SLPMR018C	292
SLPMR024	292
SLPMR024C	292
SLPR009	305

Item #	Page #
SLPR016	305
SLPS004P	308
SLPS027P	203
SLPSP008	307
SLPSP010	307
SLPSP010C	307
SLPSP012	307
SLPSP014	307
SLRACK0019	264
SLRACK0023	264
SLRACK1050	264
SLRACK1114	265
SLRACK1234	264
SLRACK1313	265
SLRACK1434	264
SLRACK1624	265
SLRACK1725	265
SLRACK1734	264
SLRBC001	339
SLRBC002	339
SLRBC003	339
SLRCD001	338
SLRCF001	236
SLRCF001F	236
SLRCF002	236
SLRCF0031GH	238
SLRCF005	236
SLRCF0171G	235
SLRCF0825	233
SLRCF0831GH	234
SLRCF0833BT	235
SLRCF0833GH	234
SLRCF0834GH	235
SLRCF0836GH	234
SLRCF0840	233
SLRCF0860	232
SLRCF100	237
SLRCF111	237
SLRCF112	237
SLRCF113	237
SLRCF114	237
SLRCF115	237
SLRCF511	233
SLRCF7100	237
SLRCF8307	232
SLRCF8311	232
SLRCF8532	233
SLRCF8533	233
SLRCF8632	232
SLRCF8633	232
SLRD008	211
SLRD020	211
SLRD038	211
SLRDH001	205
SLRDH002	205
SLRK008	307
SLRK010	307
SLRK012	307

Item #	Page #
SLRMH003	333
SLSA001	337
SLSA002	337
SLSA003	337
SLSA004	337
SLSAP4030	321
SLSAP4050	321
SLSAP4070	321
SLSBA018	297
SLSBA021	297
SLSBA111	297
SLSBA112	297
SLSBA113	297
SLSBA211	297
SLSBA212	297
SLSBA213	297
SLSBA311	297
SLSBA312	297
SLSBA313	297
SLSBA411	296
SLSBA412	296
SLSBA413	296
SLSBA511	296
SLSBA512	296
SLSBA513	296
SLSBA611	296
SLSBA612	296
SLSBA613	296
SLSBP4015	321
SLSBP4020	321
SLSBP4025	321
SLSBP4030	321
SLSC001	285
SLSC002	285
SLSC003	285
SLSCB04	284
SLSD040H	276
SLSD040V	276
SLSF111	365
SLSF112	365
SLSF113	365
SLSF114	365
SLSF115	365
SLSF116	365
SLSF117	365
SLSF118	365
SLSF119	365
SLSF120	365
SLSFP4008	319
SLSFP4009	319
SLSFP4011	319
SLSFP4012	319
SLSFP4014	319
SLSFP4108	319
SLSFP4109	319
SLSFP4111	319
SLSFP4112	319
SLSFP4114	319

INDEX BY ITEM NUMBER

S

Item #	Page #
SLSK001	314
SLSK002	314
SLSK003	314
SLSK008	353
SLSK016	353
SLSK017	353
SLSK108	353
SLSK116	353
SLSK117	353
SLSKKGK001	353
SLSKKGK002	353
SLSKR004	179
SLSKR004GV	180
SLSKR006	179
SLSKR006GV	180
SLSKR008	179
SLSKR008GV	180
SLSKR010	179
SLSKR010GV	180
SLSKR012	179
SLSKR012GV	180
SLSKR014	179
SLSKR014GV	180
SLSKR104GV	180
SLSKR106GV	180
SLSKR108GV	180
SLSKR110GV	180
SLSKR112GV	180
SLSKR114GV	180
SLSKR1213	314
SLSKR512GV	180
SLSKR513	314
SLSKR55	314
SLSKR60RL	314
SLSKR612GV	180
SLSKR613	314
SLSKR65	314
SLSKR65M	314
SLSKR70	314
SLSKR70M	314
SLSKR713	314
SLSKR80RL	314
SLSKR813	314
SLSKR875	314
SLSKR913	314
SLSKS007	314
SLSKS009	314
SLSKS514	314
SLSKS714	314
SLSL001	294
SLSL002	294
SLSL003	294
SLSM202	359
SLSM203	359
SLSM204	359
SLSM205	359
SLSM206	359
SLSM207	359

Item #	Page #
SLSM208	359
SLSM209	359
SLSM210	359
SLSM211	359
SLSM212	359
SLSN001	285
SLSN001W	285
SLSN002	285
SLSN002W	285
SLSN003	285
SLSN006D	355
SLSN006F	355
SLSN006T	355
SLSN335	285
SLSP1813	201
SLSP1826	201
SLSPA001	178
SLSPA002	178
SLSPC4012	321
SLSPC4012C	321
SLSPC4020	321
SLSPC4020C	321
SLSPG001	246
SLSPIN001	336
SLSPR022S	220
SLSPR032S	220
SLSPR042S	220
SLSPS4008	320
SLSPS4008C	320
SLSPS4012	320
SLSPS4012C	320
SLSPS4016	320
SLSPS4016C	320
SLSPS4020	320
SLSPS4020C	320
SLSPS4024	320
SLSPS4024C	320
SLSPS4032	320
SLSPS4032C	320
SLSPS4040	320
SLSPS4040C	320
SLSPS4060	320
SLSPS4060C	320
SLSPS4080	320
SLSPS4080C	320
SLSPS4100	320
SLSPS4100C	320
SLSR010	303
SLSR010TP	340
SLSR015	303
SLSR210	340
SLSS001	365
SLSS002	365
SLSS003	365
SLSS004	365
SLSS005	365
SLSS006	365
SLSS007	365

Item #	Page #
SLSS008	365
SLSS009	365
SLSS010	365
SLSS011	365
SLSSD003	338
SLSSD005	338
SLSSP4020	319
SLSSP4035	319
SLSSP4045	319
SLSSP4060	319
SLSSP4076	319
SLSSP4100	319
SLST001	275
SLST002	275
SLSTN006	315
SLSTN008	315
SLSTN009	315
SLSTN010	315
SLSTN3106	313
SLSTN3108	313
SLSTN3110	313
SLSTN3206	313
SLSTN3208	313
SLSTN3210	313
SLSTN3306	313
SLSTN3308	313
SLSTN3308R	313
SLSTN3310	313
SLSTN3310R	313
SLSTN3312R	313
SLSTN3314R	313
SLSTN3406	313
SLSTN3408	313
SLSTN3410	313
SLSTN5106	313
SLSTN5106PB	315
SLSTN5108	313
SLSTN5108PB	315
SLSTN5110	313
SLSTN5110PB	315
SLSTN5206	313
SLSTN5206PB	315
SLSTN5208	313
SLSTN5208PB	315
SLSTN5210	313
SLSTN5210PB	315
SLSTN5306	313
SLSTN5306PB	315
SLSTN5308	313
SLSTN5308PB	315
SLSTN5310	313
SLSTN5310PB	315
SLSTN5406	313
SLSTN5406PB	315
SLSTN5408	313
SLSTN5408PB	315
SLSTN5410	313
SLSTN5410PB	315

Item #	Page #
SLSTP714	186
SLSTR30	285
SLTA08	291
SLTB001	340
SLTB002	340
SLTB003	340
SLTB004	340
SLTB005	340
SLTB006	340
SLTB018R	291
SLTB018T	291
SLTCD012	338
SLTCD024	338
SLTD101	276
SLTD102	276
SLTD301	277
SLTD302	277
SLTE102	362
SLTE103	362
SLTE104	362
SLTE106	362
SLTE107	362
SLTE109	362
SLTG1600B	304
SLTG1600Y	304
SLTG208	303
SLTG309	303
SLTG310	303
SLTG407	303
SLTG408	303
SLTG607	303
SLTG608	303
SLTG706	303
SLTG709	303
SLTG712	303
SLTG810B	304
SLTG810G	304
SLTG810K	304
SLTG810R	304
SLTG810Y	304
SLTG812B	304
SLTG812G	304
SLTG812K	304
SLTG812R	304
SLTG812Y	304
SLTG816B	304
SLTG816G	304
SLTG816K	304
SLTG816R	304
SLTG816Y	304
SLTH160	267
SLTH160C	267
SLTH200	267
SLTH220C	267
SLTH550	267
SLTH550C	267
SLTH600	268
SLTHAB012	245

INDEX BY ITEM NUMBER

Item #	Page #	Item #	Page #	Item #	Page #	Item #	Page #
SLTHAB012D	245	SLTR034W	347	SLWD011	366	SLWT42496F4	377
SLTHAB020	245	SLTR045F	347	SLWD102	366	SLWT43012F	376
SLTHAB020D	245	SLTS001	367	SLWD103	366	SLWT43018F	376
SLTHCS001	289	SLTS002	367	SLWD104	366	SLWT43024F	376
SLTHCS001B	289	SLTS3151	340	SLWD105	366	SLWT43030F	376
SLTHD080	267	SLTS3152	340	SLWD106	366	SLWT43036F	376
SLTHD400	267	SLTS3153	340	SLWD107	366	SLWT43048F	376
SLTHD550	267	SLTS3154	340	SLWD109	366	SLWT43048F4	377
SLTHDP012	289	SLTS3155	340	SLWG001	265	SLWT43060F	376
SLTHDP016	289	SLTS3156	340	SLWG002	265	SLWT43060F4	377
SLTHDP020	289	SLTSCD500	277	SLWG003	265	SLWT43072F	376
SLTHDP024	289	SLTTBN024	303	SLWG1216	265	SLWT43072F4	377
SLTHDP112	289	SLTTMN008	303	SLWG1622	265	SLWT43084F	376
SLTHDP116	289	SLTTS001	295	SLWG1624	265	SLWT43084F4	377
SLTHDP120	289	SLTTS001	295	SLWH201	360	SLWT43096F	376
SLTHDP124	289	SLTWBS003	308	SLWH202	360	SLWT43096F4	377
SLTHDS005	308	SLTWBS004	308	SLWH203	360	SLWTC005	377
SLTHFB010	246	SLTWBS007	307	SLWH204	360	SLWTC005B	377
SLTHFB017	246	SLTWBT006	306	SLWH205	360	SLYK201	361
SLTHL080	268	SLTWBT010	306	SLWH206	360	SLYK202	361
SLTHL400	268	SLTWBT075	306	SLWH207	360	SLYK203	361
SLTHUH001	296	SLTWBT110	306	SLWH208	360	SLYK204	361
SLTHUT010	302	SLTWBT210	306	SLWH209	360	SLYK205	361
SLTHUT012	302	SLTWCH018	336	SLWH210	360	SLYK206	361
SLTHUT016	302	SLTWCH024	336	SLWH211	360	SLYK207	361
SLTHUT107	302	SLTWCH030	336	SLWH212	360	SLYK208	361
SLTHUT110	302	SLTWCH036	336	SLWH216	360	SLYK209	361
SLTHUT112	302	SLTWCH044	336	SLWK008	184	SLYK210	361
SLTHUT116	302	SLTWCK007	355	SLWK008C	184	SLYK211	361
SLTHUT210	302	SLTWDS006	308	SLWL001	311	SLYK212	361
SLTHUT212	302	SLTWHT003	306	SLWP064	339	SSCD003	220
SLTHUT216	302	SLTWHT004	306	SLWPF010	312	SSCD004	220
SLTHUT507	304	SLTWHT005	306	SLWPF012	312	SSCD005	220
SLTHUT610	303	SLTWHT008	306	SLWPF014	312	SSCD006	220
SLTHUT612	303	SLTWMH004	333	SLWPF016	312	STPA2001	242
SLTL001	294	SLTWMH006	333	SLWPF018	312	STPA2002	242
SLTL002	294	SLTWPC002	210	SLWPF020	312	STPA2004	242
SLTL003	294	SLTWPC004	210	SLWPF022	312	STPA2006	242
SLTL004	294	SLTWPF013	307	SLWPP110	312	STPA2121	242
SLTL005	294	SLTWPF021	307	SLWPP112	312	STPA2122	242
SLTL006	294	SLTWPS002	203	SLWPP114	312	STPA2122L	242
SLTL007	294	SLTWPS003	306	SLWPP116	312	STPA2124	242
SLTL008	294	SLTWPS005	210	SLWPP118	312	STPA2124L	242
SLTL009	294	SLTWPS006	210	SLWS004P	307	STPA2126	242
SLTL010	294	SLTWPT003	306	SLWT42412F	376	STPA2126L	242
SLTL011	294	SLTWPT003S	306	SLWT42418F	376	STPA2132	242
SLTL012	294	SLTWST010	306	SLWT42424F	376	STPA2134	242
SLTMA012	292	SLWB001	231	SLWT42430F	376	STPA2136	242
SLTMA018	292	SLWB003	231	SLWT42436F	376	STPA2142	242
SLTMA018C	292	SLWD001	366	SLWT42448F	376	STPA2144	242
SLTMA024	292	SLWD002	366	SLWT42448F4	377	STPA2146	242
SLTMA024C	292	SLWD003	366	SLWT42460F	376	STPA2162	242
SLTO18	291	SLWD004	366	SLWT42460F4	377	STPA2164	242
SLTR012F	347	SLWD005	366	SLWT42472F	376	STPA2166	242
SLTR012W	347	SLWD006	366	SLWT42472F4	377	STPA2192	242
SLTR023F	347	SLWD007	366	SLWT42484F	376	STPA2194	242
SLTR023W	347	SLWD008	366	SLWT42484F4	377	STPA2232	242
SLTR034F	347	SLWD009	366	SLWT42496F	376	STPA2234	242

S

INDEX BY ITEM NUMBER

S
to
Y

Item #	Page #
STPA2236	242
STPA3001	242
STPA3001PF	243
STPA3002	242
STPA3002PF	243
STPA3004	242
STPA3004PF	243
STPA3006	242
STPA3006PF	243
STPA3022	243
STPA3121	242
STPA3121PF	243
STPA3122	242
STPA3122L	242
STPA3122PF	243
STPA3124	242
STPA3124L	242
STPA3124PF	243
STPA3126	242
STPA3126L	242
STPA3126PF	243
STPA3132	242
STPA3134	242
STPA3136	242
STPA3142	242
STPA3144	242
STPA3146	242
STPA3162	242
STPA3164	242
STPA3166	242
STPA3192	242
STPA3194	242
STPA3232	242
STPA3234	242
STPA3236	242
STPA4002	243
STPA4004	243
STPA4006	243
STPA4122	243
STPA4124	243
STPA4126	243
STPA4132	243
STPA4134	243
STPA4136	243
STPA4142	243
STPA4144	243
STPA4146	243
STPA4162	243
STPA4164	243
STPA4166	243
STPA4192	243
STPA4194	243
STPA5000C	243
STPA5000CS	243
STPA5120C	243
STPA5120CL	243
STPA5120CS	243
STPA5120CSL	243

Item #	Page #
STPA5130C	243
STPA5130CS	243
STPA5140C	243
STPA5140CS	243
STPA5160C	243
STPA5160CS	243
STPA5190C	243
STPA5190CS	243
STPA5230C	243
STPA5230CS	243
T-111	195
T-111C	195
T-333	195
TF001	185
TF002	185
TIM-60	266
TJWB007	341
TJWB010	341
W7009	175
W7101	175
W7102	175
W7103	175
W7104	175
W7105	175
W7106	175
WBEP014	375
WBEP018	375
WBEP021	375
WBEP024	375
WBEP214	375
WBEP218	375
WBEP221	375
WBEP224	375
WBSV014	375
WBSV018	375
WBSV021	375
WBSV024	375
WBSV214	375
WBSV218	375
WBSV221	375
WBSV224	375
WBDS011H	317
WBDS014	317
WBDS020H	317
WBDS027H	317
WDFJ001	353
WDGB012	268
WDGB018	268
WDGB024	268
WDM1008W	221
WDPB001	269
WDPB001N	269
WDPB002	269
WDPB002N	269
WDPB003	269
WDPB003N	269
WDPB004	269
WDPB004N	269

Item #	Page #
WDPB005	269
WDPB005N	269
WDPB006	269
WDPB006N	269
WDPB037	317
WDPP1222	210
WDPP1236	210
WDPP1242	210
WDPP1424	210
WDPP1436	210
WDPP1442	210
WDPP1642	210
WDPP1842	210
WDPP2042	210
WDRNP013	211
WDRNP015	211
WDRNP018	211
WDSP012	178
WDSP014	178
WDSP016	178
WDSP018	178
WDSP1107	354
WDSP1108	354
WDTHBS018	367
WDTHBS019	367
WDTHBS020	367
WDTHHC018A	367
WDTHHC019A	367
WDTHHC020A	367
WDTHMP018	263
WDTHMP020	263
WDTHMP024	263
WDTHMP030	263
WDTHMP036	263
WDTHMP042	263
WDTHMP048	263
WDTHMP054	263
WDTHMP060	263
WDTHS032	367
WDTSB006	347
WDTSB008	347
WDTSB010	347
WDTSB012	347
WDTSB014	347
WDTSB016	347
WDTSB018	347
WDTSB020	347
WDW06768	219
WDWB008	317
WDWB012	317
WDWB020	317
WOBOAT61	192
WOBOAT76	192
WOBOAT90	192
WOBR43	192
WOBR57	192
WSPB001	193
WSPB002	193

Item #	Page #
WSPB003	193
WSPW001	193
WSPW002	193
WSPW003	193
Y-15	193
Y-35	193
Y-55	193
Y-75	193
Y-95	193

CREDIT POLICY

Standard terms are **Cash-In Advance** or **Net 30 Days** (with approval credit). All new accounts should supply three (3) trade references and bank's name and address. No order will be processed until a satisfactory credit check has been made or unless the order is accompanied by a CREDIT CARD payment. **No orders will be shipped C.O.D. without prior credit approval.** Credit limits will be established and communicated upon approval of credit. Increased credit limits can only be achieved by a history of prompt payments. Late payments will be charged interest at the rate of 1½% per month or the highest allowable by law on all invoices over 30 days.

RETURN POLICY

To ensure proper credit, **all returned merchandise must have a Return Goods Authorization (RGA) Number.** All goods returned for credit will only be accepted within sixty (60) days of original invoice date. All changes to orders or cancellations will be at the discretion of THUNDER GROUP. Charges for changes will be in accordance with any work already processed before change is requested. Returned goods must be in their original packaging & in restocking condition. Absolutely no returns after merchandise has been used. All authorized returns are subject to a 15% restocking charge and must be shipped back on a prepaid basis.

DAMAGED MERCHANDISE

Inspect the shipment as soon as received thoroughly. All our shipments have been counted and accepted by carriers. If any concealed loss or damage is discovered, please contact the freight company at once and request an inspection. If the freight company does not make the inspection, file an affidavit specifying date of notification and freight company's failure to inspect. This will support your claim properly in the future. THUNDER GROUP is **NOT** responsible for any loss or damage once the delivery receipt is signed by the customer.

SHIPPING POLICY

THUNDER GROUP will make every attempt to ship the best way in the absence of specific written shipping instructions. THUNDER GROUP reserves the right to delay or cancel all shipments if the account is delinquent or exceeds credit limit. THUNDER GROUP will endeavor to ship as quickly as possible (usually three to five days on standard items). If a specific ship date is required, please indicate that date along with the words "MUST SHIP". If THUNDER GROUP is unable to meet your requested ship date, we will make every effort to notify you as quickly as possible. **THUNDER GROUP is not responsible for any delays in shipment for causes beyond its control.**

MINIMUM ORDER POLICY

All prices are quoted F.O.B. Los Angeles or Warehouses and are subject to change without notice. **Minimum initial order is \$250 net, Minimum re-order is \$150 net.** MERCHANDISE ONLY SOLD IN INNER CASE PACK. A minimum 10% upcharge will be assessed for any broken inner pack quantities on applicable products. "Sold by Master Pack Only" items are excluded from Inner Pack breaking. All Back Orders are automatically cancelled unless noted on original purchase orders.



THUNDER GROUP®

780 South Nogales Street, City of Industry, CA 91748

CITY OF INDUSTRY, CA

Tel: 626.935.1605

Toll Free: 866.827.4664

Fax: 626.935.1609

Email: cservice@tarhong.com

Web: www.thundergroup.com

NEW ACCOUNT APPLICATION

For Dealer & Distributor only

DATE: _____

RESALES NO.: _____

TH NO.: _____

D & B NO.: _____

APPLICATION INFORMATION

COMPANY NAME _____

ADDRESS _____

CITY _____ STATE _____ ZIP _____

CONTACT PERSON _____

ACCOUNTS PAYABLE CONTACT _____ PHONE NUMBER _____

NUMBER OF EMPLOYEES HERE _____ NO. OF YEARS IN BUSINESS UNDER THIS NAME _____ SALES VOLUME _____ CREDIT LINE REQUESTED _____

TYPE OF BUSINESS

SOLE PROPRIETORSHIP

PARTNERSHIP

CORPORATION IN STATE OF _____

SUBSIDIARY

DIVISION

OWNERSHIP	NAME OF OWNER	PHONE NUMBER	FAX NUMBER
	HOME ADDRESS	CITY	STATE ZIP
	NAME OF OWNER	PHONE NUMBER	FAX NUMBER
	HOME ADDRESS	CITY	STATE ZIP

TRADE REFERENCE	NAME OF BUSINESS	PHONE NUMBER	FAX NUMBER	CONTACT PERSON
	ADDRESS	CITY	STATE	ZIP
	NAME OF BUSINESS	PHONE NUMBER	FAX NUMBER	CONTACT PERSON
	ADDRESS	CITY	STATE	ZIP
	NAME OF BUSINESS	PHONE NUMBER	FAX NUMBER	CONTACT PERSON
	ADDRESS	CITY	STATE	ZIP
	NAME OF BUSINESS	PHONE NUMBER	FAX NUMBER	CONTACT PERSON
	ADDRESS	CITY	STATE	ZIP

BANK REFERENCE	NAME OF BANK	PHONE NUMBER	FAX NUMBER
	ADDRESS	CITY	STATE ZIP

PLEASE ATTACH A VALID COPY OF YOUR RESALE CERTIFICATE

APPROVED DISCOUNT: _____ APPROVED TERM: _____

CREDIT APPROVED _____
 CREDIT DISAPPROVED _____

DATE ____ / ____ / ____

All statements made herein are true and accurate. We here by indemnify the above company and its agents, from and any liability resulting from the credit application.

AUTHORIZED SIGNATURE _____

TITLE _____ DATE ____ / ____ / ____

5 MAJOR STEPS

1. Call the Service Center
2. Provide Proof of Purchase and Serial Number
3. Obtain a RGA number
4. Pack well and send back.
5. Repair and return back to the customer

Distributor should NEVER exchange the product to the Customer without first consult with Thunder Group's Customer Service Department. We will not honor any return or exchange without a RGA number.



THUNDER GROUP®

www.thundergroup.com

SUBJECT: RETURN AUTHORIZATION POLICY AND PROCEDURE

In the event that customers have a problem, either warranty or non-warranty related; customers should take the following steps to ensure the problem is handled professionally.

When a problem arises, customers have to call in the following Thunder Group Service Center:

- City of Industry, CA Tel: 866.TARHONG Fax: 626.935.1609

How to determine if the problem is a warranty-related problem:

- It has to be under the manufacturer original warranty.
 - a. 1 year from the date of original purchase by the end user for all **ELECTRIC** Rice Cooker/Warmer Products; or
 - b. 1 year from the date of original purchase by the end user for all **Rinnai GAS** Rice Cooker/Grill
 - c. 5 Year Limited warranty against manufacturer defect, i.e. rust on all chrome and epoxy plated shelving.
- Customers/End Users have to present proof of purchase from its supplier or vendor in order to valid the warranty period. Fax copy is acceptable.
- Customers/End users have to provide a valid serial number for the product.
- No sign of misuse or abuse of the products.

If the problem is determined to be a **warranty-related** problem:

- Return Authorization Specialist will issue a RGA number to the customer.
- Customers have 30 days to return the product(s), freight pre-paid, to our service center.
- On-site technician will determine the cause of the problem and perform any necessary repair (repair time is usually 7 days, however, Thunder Group reserves the right to extend the length of the repair if the problem needs more special attention).
- Thunder Group is responsible for all labor and parts.
- Products will be shipped back to the customer, freight pre-paid.
- Warranty for the repair work is 30 days or the remaining of the original warranty period; whichever is favorable to the customer.

If the problem is determined to be a **non-warranty-related** problem:

- Customers can request parts-sheet to be faxed to them and order parts in order to perform the repair themselves; or
- Customers can send back the product for a non-warranty repair with authorization to repair the unit.
- Repair fee is **USD 85.00** per hour plus the cost of parts.
- Product will be shipped back to the customer at freight collect.

**Thunder Group will not honor any payment deduction for warranty-related issue without authorization or damages caused by shipping.
Credit Card Payment: Surcharge will be applied.**

RECOMMENDATION:

- Customer should keep the original Sales receipt and the Serial number during the warranty period.
- Customer should fill out and send back the warranty card that came with the product upon purchase.
- Customer should always maintain and clean the products from dusts and cooking residues.
- Customer should always unplug the unit when not using.
- Always read the user manual/warranty policy before operating the unit.

CALIFORNIA

780 South Nogales St.
City of Industry, CA 91748
Tel: 866-827-4664
Fax: 626-935-1609

ILLINOIS

8402 #E West 183rd St.
Tinley Park, IL 60487
Tel: 855-395-5560
Fax: 708-429-7125

FLORIDA

10599 NW 67th St.
Tamarac, FL 33321
Tel: 877-766-6525
Fax: 954-337-0222

TEXAS

10702 Cash Rd.
Stafford, TX 77477
Tel: 713-690-0111
Fax: 713-690-0123

NEW JERSEY

33 Truman Drive South
Edison, NJ 08817
Tel: 732-777-1977
Fax: 732-777-0117

CORPORATE - CALIFORNIA

780 South Nogales Street
City of Industry, CA 91748
Tel: (626) 935-1605
Fax: (626) 935-1609

NEW YORK BRANCH
33 Truman Drive South
Edison, NJ 08817
Tel: (732) 777-1977
Fax: (732) 777-0117
eFax: (626) 551-0388



TEXAS BRANCH
10702 Cash Road
Stafford, TX 77477
Tel: (713) 690-0111
Fax: (713) 690-0123
eFax: (626) 465-4692

ILLINOIS BRANCH
8402 #E West 183rd Street
Tinley Park, IL 60487
Tel: (855) 395-5560
Fax: (708) 429-7125

FLORIDA BRANCH
10599 NW 67th Street
Tamarac, FL 33321
Tel: (954) 724-5214
Fax: (954) 337-0222

WWW.THUNDERGROUP.COM

Melamine Dinnerware • Asian Cookware • Asian Tableware • Bakeware & Supplies • Bar Supplies • Catering & Buffetware
• Food Preparation • Gas & Electric • Janitorial • Kitchen Utensils • Professional Cookware • Table Top Services • Signage
• Shelving • Worktable • Melamine Dinnerware • Asian Cookware • Asian Tableware • Bakeware & Supplies • Bar Supplies
• Catering & Buffetware • Food Preparation • Gas & Electric • Janitorial • Kitchen Utensils • Professional Cookware • Table
Top Services • Signage • Shelving • Worktable • Melamine Dinnerware • Asian Cookware • Asian Tableware • Bakeware
& Supplies • Bar Supplies • Catering & Buffetware • Food Preparation • Gas & Electric • Janitorial • Kitchen Utensils • Pr
fessional Cookware • Table Top Services • Signage • Shelving • Worktable • Melamine Dinnerware • Asian Cookware • A
Tableware • Bakeware & Supplies • Food Preparation • Gas & Electric • Janitorial
Kitchen Utensils • Professional Cookware • Worktable • Melamine Dinnerware
Asian Cookware • Asian Tableware • Catering & Buffetware • Food Preparation •
& Electric • Janitorial • Kitchen Utensils • Professional Cookware • Signage • Shelving • Worktable
Melamine Dinnerware • Asian Cookware • Asian Tableware • Bakeware & Supplies • Bar Supplies • Catering & Buffetware
• Food Preparation • Gas & Electric • Janitorial • Kitchen Utensils • Professional Cookware • Table Top Services • Signage

USD \$60.00 • email: sales@thundergroup.com
 THUNDER GROUP IS NOT RESPONSIBLE FOR PRINTING ERRORS.
 PRICE MAY CHANGE WITHOUT NOTICE.

SURCHARGE WILL APPLY